

---

# kortho

# MANUAL

---

## QiC 53c Thermal Transfer Printer



## **bv korthofah**

P.O. box: 3040  
2220 CA, Katwijk  
The Netherlands

Tel: +31 71 40 60 480  
Fax: +31 71 40 32 807  
E-mail: [export@kortho.nl](mailto:export@kortho.nl)  
Internet: [www.kortho.com](http://www.kortho.com), [www.kortho.eu](http://www.kortho.eu)

In light of continuous development and improvement, Korthofah BV reserves the right to modify the specifications without prior notice. The figures printed in this manual may slightly differ from the Kortho GraphicJet. Information in this document is subject to change without notice.

No part of this document may be reproduced or transmitted in any form or by any means, electronic or mechanical, without the written permission of Korthofah BV.

Document date: 26/06/2015  
Manual: H325 AE QiC 53c EN 001.doc  
Number of pages: 162

The basis for this manual is:

Series: QiC 53c  
Production year: 2013  
Original language: English

Standard models: QiC 53c + TsC12  
QiC Control version: V1.0-150429A

Copyright © 2015 **bv korthofah**  
All Rights Reserved



QiC, QiC Draw, the **kortho** logo and the **bv Korthofah** logo are trademarks of Korthofah BV. All other brand and product names in this manual are the trademarks or registered trademarks of their respective holders.

Printed in the EC 2015

## ▪ Preface

Welcome to the QiC 53c manual.

Read the manual before you start and read it carefully. This will avoid unnecessary problems and loss of performance.

This manual is meant for all personnel who are involved with the QiC 53c printer. The purpose of this manual is to get familiar with the QiC 53c printer. This involves operational, safety, transport & storage, installation, commissioning, fault diagnosis and maintenance instructions.

All personnel must read the first four sections named INTRODUCTION, TECHNICAL DESCRIPTION, PRINT PROCESS DESCRIPTION and SAFETY. The other sections provide instructions or information for different aspects of the QiC 53c printer.

Keep this manual on a sensible and safe place for future use.

Contact Korthofah BV or your local distributor if you have any questions.

Conventions in this manual:

- The QiC 53c printer will be referred to as the printer.
- Any material the printer is used to print on is called substrate.
- The customer is the person or company who is the owner of the printer.
- Follow the instruction order as indicated when you carry out any of the procedures described.

Instruction format:

Instruction. Comment(s).

a. Sub-instruction. Comment(s).

b. Sub-instruction. Comment(s).

Instruction. Comment(s).

## ▪ Symbols in this manual

In this manual, the following symbols are used:



**WARNING:**

This symbol indicates a potentially hazardous situation which, if instructions are not followed, could result in death or serious injury.



**CAUTION:**

This symbol indicates a potentially hazardous situation which, if instructions are not followed, may result in minor or moderate injury or damage to property.

The statements above are notes for your safety.



**Beware:**

A notice with useful information for the user in relation to the product. It attends the user to possible problems.



**Note:**

Gives the user suggestions and helps the work to be carried more rapidly.

## ■ Glossary

Bitmap:	A data file or structure. A set of bits that represents a graphic image, with each bit or group of bits corresponding to a pixel in the image.
Host:	A machine or production system that handles the product or substrate and can be connected by an interface to the printer, e.g. a printer alarm to stop the machine.
Index:	Distance between two printed areas on the used ribbon, also known as 'ribbon gap'.
Label:	A design file from which the printer generates the bitmap to print. This design file can contain a unique combination of text, numeric, date, time, barcode and/or graphical items.
Label memory:	Memory on the MMI board in which the labels can be stored. From this memory labels can be selected for printing (stored in the print memory).
Pixel:	A pixel is the smallest portion of a bitmap. For a printer one pixel represents one dot (= one sequence of heating up of a single heating element of the print head).
Print:	The result of printing a label on a substrate.
Print memory:	Memory on the main board (PX2) in which the label to be printed is stored. Only one label can be printed at the same time, so only one label can be stored in this memory.
Print request:	A signal generated by a sensor or host machine. It is a trigger to start a print cycle.
Print cycle:	The moment from which the printer accepts a print request until the printer is ready to accept a new print request.
Product:	In this manual, the items the printer prints on, e.g. a box, package etc.
QiC Draw:	A design tool on a PC to create and edit labels. It also contains a service module which can be used during service/problem solving.
Ribbon:	Thermal transfer ribbon, pigment carrier foil.
Sensor:	A product detection device connected to the control unit.
Substrate:	This is the material of a product to print on, e.g. packaging foil.

## ■ Table of contents

▪	Preface.....	iii
▪	Symbols in this manual.....	iii
▪	Glossary.....	iv
▪	Table of contents .....	v

## 1 INTRODUCTION

1.1	Qualified personnel.....	1-1
1.2	Elementary personal protection.....	1-1
1.3	Intended Use.....	1-1
1.4	Specifications.....	1-2
1.4.1	Coding unit .....	1-2
1.4.2	Control unit.....	1-2
1.4.3	Ribbon .....	1-3
1.4.4	Label features.....	1-4
1.4.5	Life span.....	1-4
1.4.6	Electrostatic charge.....	1-5
1.4.7	Shock & vibration .....	1-5

## 2 TECHNICAL DESCRIPTION

2.1	The printer system .....	2-1
2.2	Coding unit.....	2-2
2.3	Control unit.....	2-4
2.4	Air supply .....	2-4
2.5	Label design.....	2-5
2.5.1	QiC Draw label design software.....	2-5
2.5.2	NiceLabel .....	2-6

## 3 PRINT PROCESS DESCRIPTION

3.1	Print cycle .....	3-1
3.2	Printhead.....	3-1
3.3	Coding unit.....	3-2
3.4	User interface .....	3-2
3.4.1	Menu structure .....	3-2
3.4.2	LED indicators on control unit .....	3-3
3.4.3	LED indicators and front button on coding unit .....	3-4
3.4.4	Keyboard .....	3-4
3.4.5	System information.....	3-9
3.4.6	Menu structure .....	3-9

## 4 SAFETY

4.1	Control unit.....	4-1
4.1.1	General information.....	4-1
4.1.2	Power supply.....	4-1
4.1.3	Precautions before power-up .....	4-2
4.1.4	Precautions when opening the control unit .....	4-2
4.2	Anti-static precautions .....	4-3
4.2.1	Printhead .....	4-3
4.2.2	Printed circuit boards.....	4-3

## 5 TRANSPORT & STORAGE

5.1	Printer equipment.....	5-1
5.1.1	Shipping and handling.....	5-1
5.1.2	Pre-transport procedure.....	5-1
5.1.3	Pre-storage procedure.....	5-2
5.2	Ribbon.....	5-2
5.2.1	Handling and storage.....	5-3
5.2.2	Transport information.....	5-3

## 6 INSTALLATION

6.1	Requirements.....	6-1
6.1.1	Provided by the customer:.....	6-1
6.1.2	Equipment.....	6-1
6.2	Unpacking.....	6-1
6.2.1	Coding unit QiC 53c.....	6-1
6.2.2	Control unit TsC12.....	6-2
6.2.3	Printhead cleaning set.....	6-2
6.3	Mounting the coding unit.....	6-3
6.3.1	Coding unit mounting support.....	6-3
6.3.2	Encoder.....	6-3
6.3.3	Substrate adjustment.....	6-4
6.3.4	Air supply.....	6-5
6.4	Mounting the control unit.....	6-5

## 7 COMMISSIONING

7.1	Initial setup.....	7-1
7.1.1	Load the ribbon on the magazine.....	7-1
7.1.2	Aligning the printhead to the platen roller.....	7-2
7.2	Preparing the control unit.....	7-3
7.3	Optimising the print quality.....	7-3
7.4	User settings.....	7-5

## 8 OPERATION

8.1	Powering up.....	8-1
8.2	Operational.....	8-2
8.2.1	Start printing.....	8-2
8.3	Operator data input.....	8-2
8.3.1	Text item input menu.....	8-3
8.3.2	Date advance input menu.....	8-4
8.3.3	Number start value input menu.....	8-5
8.4	Label management.....	8-6
8.4.1	Selecting a label for printing.....	8-6
8.4.2	Transferring labels to the controller.....	8-6
8.4.3	Moving a label.....	8-9
8.4.4	Deleting a label.....	8-10
8.4.5	Showing a preview.....	8-11
8.5	Magazine handling.....	8-12
8.5.1	Removing the magazine.....	8-12
8.5.2	Placing the magazine.....	8-12
8.5.3	(Re)placing ribbon.....	8-13
8.6	Adjusting printer settings.....	8-13
8.6.1	System settings.....	8-14
8.6.2	Printer settings.....	8-19
8.6.3	Signal settings.....	8-20

8.6.4	Network settings.....	8-23
8.6.5	Label settings.....	8-24
8.6.6	Print settings.....	8-26

## 9 DIAGNOSTICS / TROUBLESHOOTING

9.1	Diagnostics.....	9-1
9.1.1	Test labels.....	9-1
9.1.2	Printer.....	9-3
9.1.3	Fonts.....	9-6
9.1.4	Diagnostics.....	9-6
9.1.5	Test.....	9-8
9.1.6	Reset Ribbon.....	9-9
9.2	Information.....	9-10
9.2.1	General.....	9-11
9.2.2	System Info.....	9-12
9.2.3	Health.....	9-13
9.2.4	Upgrade.....	9-13
9.2.5	Backup.....	9-15
9.2.6	Report.....	9-17
9.3	Screen calibration.....	9-19
9.4	Fault finding.....	9-20
9.4.1	Control unit.....	9-20
9.4.2	Coding unit.....	9-22
9.4.3	Print request signal sensor.....	9-23
9.5	Error/warning messages.....	9-23
9.6	Poor print quality.....	9-24

## 10 MAINTENANCE

10.1	Daily maintenance.....	10-1
10.1.1	Printhead.....	10-1
10.1.2	Platen roller.....	10-2
10.2	Maintenance after replacing the ribbon roll.....	10-2
10.3	Weekly maintenance.....	10-3
10.4	Half yearly maintenance.....	10-3
10.5	Printhead replacement.....	10-3
10.5.1	Printhead safety notes.....	10-3
10.5.2	Printhead replacement.....	10-4
10.6	Updating firmware and software.....	10-5

## 11 DISMANTLING & DISPOSAL

11.1	Dismantling.....	11-1
11.1.1	System.....	11-1
11.1.2	Coding unit.....	11-1
11.1.3	Control unit.....	11-1
11.1.4	Sensor devices.....	11-1
11.1.5	Ribbon.....	11-1
11.2	Disposal.....	11-2
11.2.1	Disposal method.....	11-2
11.2.2	Waste separation.....	11-2

## Index

▪	Keywords.....	I
▪	Figures.....	III

## Appendices

Appendix A	Specifications.....	A-1
Appendix B	Dimensions .....	B-1
Appendix C	Part lists & illustrations .....	C-1
Appendix D	Connections.....	D-1
Appendix E	NiceLabel driver tutorials .....	E-1
Appendix F	Quick reference .....	F-1
Appendix G	Error list .....	G-1



# 1 INTRODUCTION

## 1.1 Qualified personnel

Operators are qualified when they have read and understand sections 1 to 8 of this manual. A specific preliminary training is not required.

Technicians that carry out repairs and technical maintenance on the printer equipment should have secondary technical education or comparable technical level of knowledge through practical experience.

Installation or servicing of the printer must only be performed by qualified personnel of Korthofah BV. For customer installations authorisation must be obtained from Korthofah BV or a local distributor, which is designated by Korthofah BV.

## 1.2 Elementary personal protection

- When installing or servicing the equipment ensure that the host machine is stopped.
- When installing or servicing the equipment ensure the control unit of the printer is switched off.

Please read chapter 4 SAFETY for more information

## 1.3 Intended Use

The QiC 53c Thermal Transfer Printers are industrial printers and are designed to print directly on substrates e.g. packaging foils. The printer can print labels with fixed and/or dynamic items. Dynamic items are items like operator input text, number, date and time. Beside text related items, the printer can also print items such as barcodes, shift-codes and images.

The labels will be designed with a PC based design tool and downloaded by the user. The labels can be downloaded to the controller by Ethernet or by USB thumbdrive. Ethernet can be used to download a label to the print memory. By using the USB thumbdrive many labels can be copied to the label memory. While selecting a label for printing the label will be transferred from the label memory to the print memory. The print memory can only hold one label.

Normal use means use under normal conditions as described in this manual i.e. use ribbons recommended by Korthofah BV and use only original spare parts.

The printer may not be used in areas which have a fire or explosion hazard.

Korthofah BV does not accept any liability for damage to the equipment or personal injury resulting from improper use of the equipment or improper maintenance. Neither does Korthofah BV accept any liability for the normal wear-and-tear of the equipment.

## 1.4 Specifications

Only general specifications are described in this section. Refer to Appendix A for more detailed specifications.

### 1.4.1 Coding unit

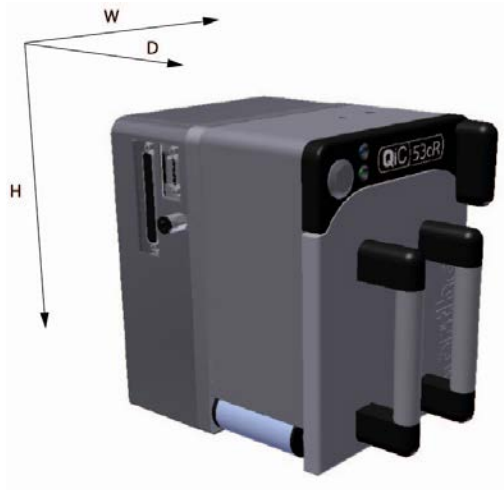

Fig. 1.1 Coding units, global dimensions

A general impression of the coding unit dimensions is given in Fig. 1.1. The dimensions (H x W x D) of the coding unit QiC 53c are 210mm x 152mm x 210mm (bracket and cables excluded, see section 6.3.1 and 6.3.2)

The coding unit can print an area of 53,3mm x 200mm.

The ambient temperature must be between 5 °C and 40 °C, with a relative humidity between 10% and 90% (non condensing).

Use only Kortho thermaltransfer ribbon for this printer.

### 1.4.2 Control unit

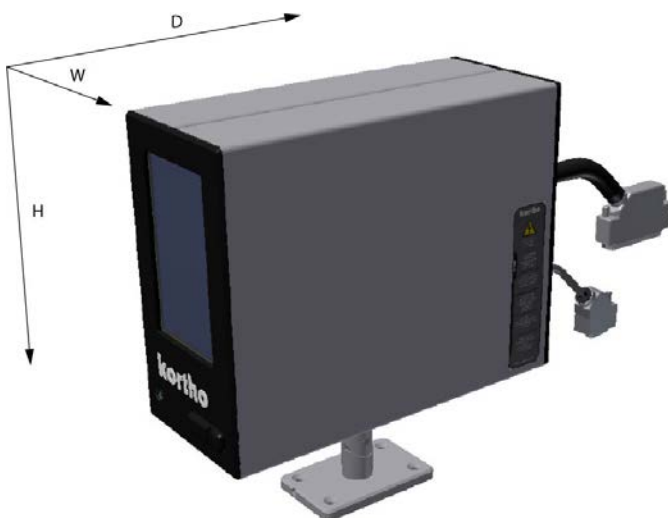

Fig. 1.2 Control unit, global dimensions

## INTRODUCTION

A general impression of the control unit TsC12 dimensions is given in Fig. 1.2. The dimensions (H x W x D) of the control unit TsC12 are 186mm x 98mm x 239mm.

The electrical requirements for the power supply are a voltage between 90 and 264VAC and a frequency between 47 and 63Hz. The maximum power consumption of the control unit is 40VA. The control unit is equipped with two fuses (5x20 mm) with a rating of F3,15A (slow acting).

All external equipment that is connected to the control unit interface must be double insulated to qualify the whole installation as a separated extra-low voltage (SELV, Class II) system.

The control unit has a bespoke hardware user interface, communication ports and host I/O-ports.

The ambient temperature must be between 5 °C and 40 °C, with a relative humidity between 10% and 90% (non condensing).

### 1.4.3 Ribbon

The ribbon supplied by Korthofah BV is specifically selected for the QiC Thermal Transfer Printer range. It guarantees an optimal print head protection and so print head life time in combination with an optimal print result. In order to guarantee an optimal print result on each packaging material Korthofah BV supplies a wide range of different ribbon types. In addition, ribbons are available in a variety of colours.

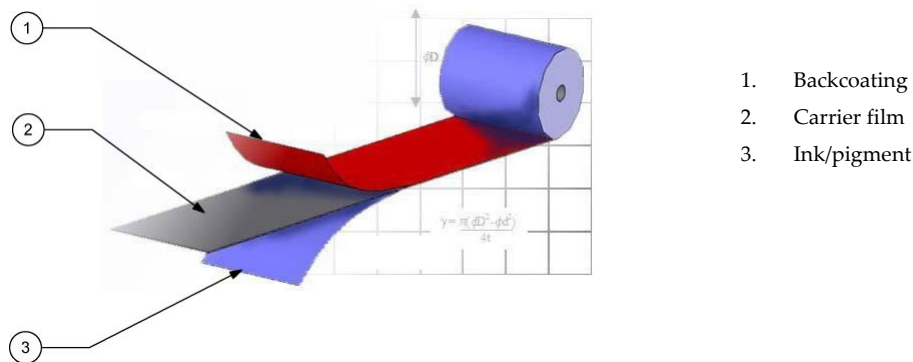

Fig. 1.3 Ribbon

Ribbon is composed of three layers: Backcoating, Carrier film and Ink.

The backcoating contains extremely small beads of silicon which protect the sensitive printhead from abrasion, provides excellent heat conductivity to enable the ink to transfer to the substrate and reduces the formation of static electricity, which is harmful to the printer and its operator. Cheaper ribbons without this protection can damage the printhead.

The polyester film carrier provides the mechanical stability ensuring the ribbon doesn't break under the stresses of acceleration yet allows the heat developed by the thermal printhead to be transferred into the ink.

The ink formulation balances wax and resins to produce the optimum print quality based upon printhead technology, the substrate being printed, print speed and environmental conditions (e.g. ambient temperature and humidity).

The thermal ribbon should be stored in a dark, dry and cool place.

The recommended ambient temperature while printing is between 10 °C and 30 °C.

### 1.4.4 Label features

#### Label:

- Name: User defined name.
- Test label: A label that is permanently available (can not be deleted) and specifically designed for making test prints to check the print quality and the correct setting of several parameters.
- Items: Text, multiple line text, number, date, time, shiftcode, barcode, line and box items and graphic. These items are placed in an label with the labeldesign software.
- Data: Fixed and variable.
- Size: Maximal 96kB .
- Max. items: 7 number items per label. 1000 external or 400 internal characters per text item (including check characters).

#### Font:

- Internal: 6 fonts are preinstalled on the system; Liberation Sans, Liberation Serif, Tahoma, Century Gothic, Arial black and ArabDigit Black. In addition extra fonts can be stored. The system offers full downloadable font support for Windows TrueType fonts. The font ArabDigit Black can only be used for Arabic digits, e.g. time, date and numbers. The other internal fonts can be used to print fixed an variable text e.g. time, date, operator input text, see section 9.1.3.
- External: fonts used in an label but not installed on the system. External fonts will be treated as fixed data/text. So if an external font is used in e.g. a time item, the system will start printing the time at which the label has been loaded in the print memory, but will not update it during the print process. I.e. the system will print the same time during the complete production batch.

**Barcode formats:** Several barcode formats are available among which Codabar, Code 2 of 5, Code128, Data Matrix, EAN128, EAN13, EAN8, RSS-14, UPC A. For a complete list see section Appendix A. Barcodes will be printed as fixed items.

#### Items:

- Graphic: In jpg, jpeg or bmp format (black/white).
- Dynamic: Number, date, time and shiftcode.
- Operator input: Text, number, date.

**Label download:** Through Ethernet or a USB thumbdrive. Ethernet can be used to download a label to the print memory. By using the USB thumbdrive a lot of labels can be copied to the label memory. While selecting a label for printing the label will be transferred form the label memory to the print memory. The print memory can only hold one label.

**Storage capacity:** 55MB (approximately 570 labels of the maximum label size).

### 1.4.5 Life span

The life span of the equipment is five years, except for the printhead, under normal use and in compliance with the indicated maintenance periods.

The life span can be negatively influenced by improper/uninformed use of the equipment or improper maintenance, repair or modification by unqualified personnel, or repair with non original parts. No claims for guarantee or compensation for damages will be accepted in such instances.

### 1.4.6 Electrostatic charge

Make sure that the substrate is not able to build up an electrostatic charge near the printhead, i.e. use conductive rolls and bearings for substrate guidance, place a ESD brush or an ionizing air bar just before the printer.

An electrostatic charge will disturb the print by electrostatic influence on the printhead, this may cause permanent printhead failure.

### 1.4.7 Shock & vibration

The printer should be installed on a low vibration location.

It is recommended that the coding unit is protected from shock and vibration, as this will have severe impact on the printed label quality and printhead life.



## 2 TECHNICAL DESCRIPTION

This section is meant for all users. It describes all the main parts of the printer system.

### 2.1 The printer system

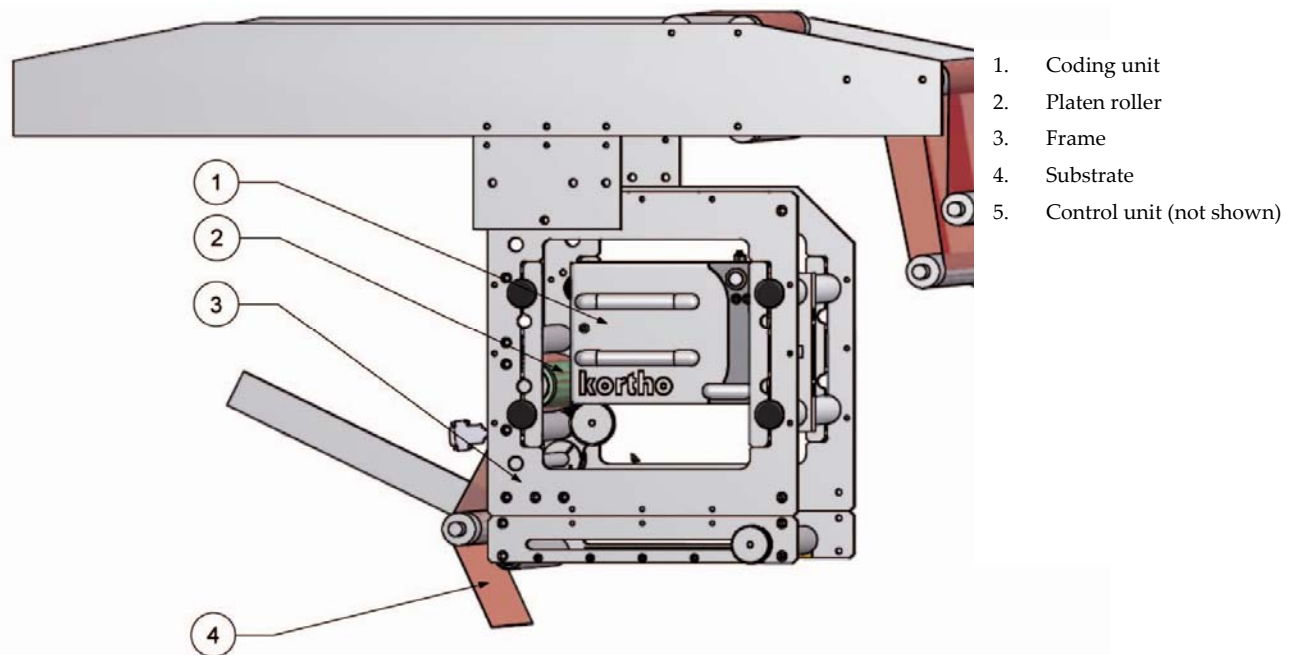

Fig. 2.1 The printer system

A typical thermal transfersystem is shown in Fig. 2.1. The substrate is placed on a continuous packaging machine and passes between the coding unit and the platen roller. During the movement of the substrate, the QiC 53c receives a print-request signal from the host machine or print sensor and the selected label will be printed on the substrate.

The thermal printhead receives the label line by line from the buffer memory and prints it on the substrate. The resolution is always 12 dots/mm (300 DPI) in width and 12 dots/mm (300 DPI) in length.

Directly after printing, the variables in the label are updated.

After finishing the print cycle (ramp up, print ramp down and reverse ribbon) the QiC 53c is in stand-by mode again and awaiting the next print request signal.

After receiving the next print request signal the time and date items will be updated after which the system will print the completely updated label.

The coding unit is connected to the control unit. All connections between printer and peripheral devices are made on the control unit i.e. print request signal, alarm signals and ethernet connection.

## 2.2 Coding unit



1. Printer body
2. Magazine

Fig. 2.2 Coding unit, parts



1. Ribbon movement sensor (behind finger guard)
2. Finger guard
3. Connection to air supply
4. Connection to control unit
5. Front button
6. Status LED
7. Magazine handle
8. Magazine ribbon drive
9. Magazine guide
10. Thermal Printhead

Fig. 2.3 Coding unit, interior parts front

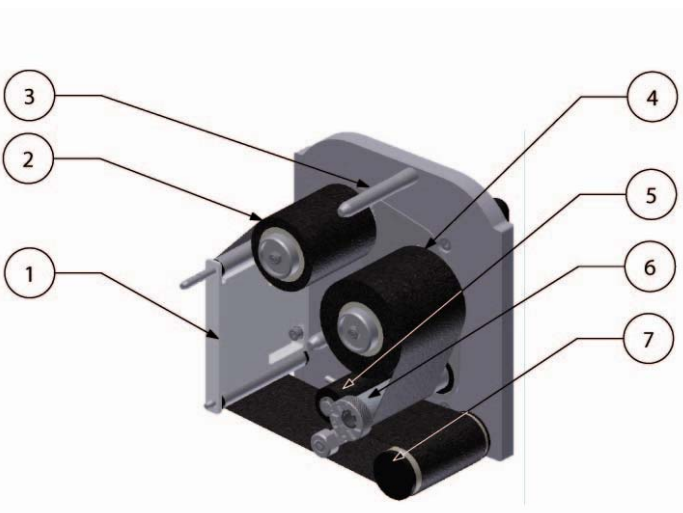

1. Finger guard
2. Used ribbon
3. Guide post
4. New roll of ribbon
5. Pressure roller
6. Ribbon drive roller
7. Ribbon sensor roller

Fig. 2.4 Magazine, parts



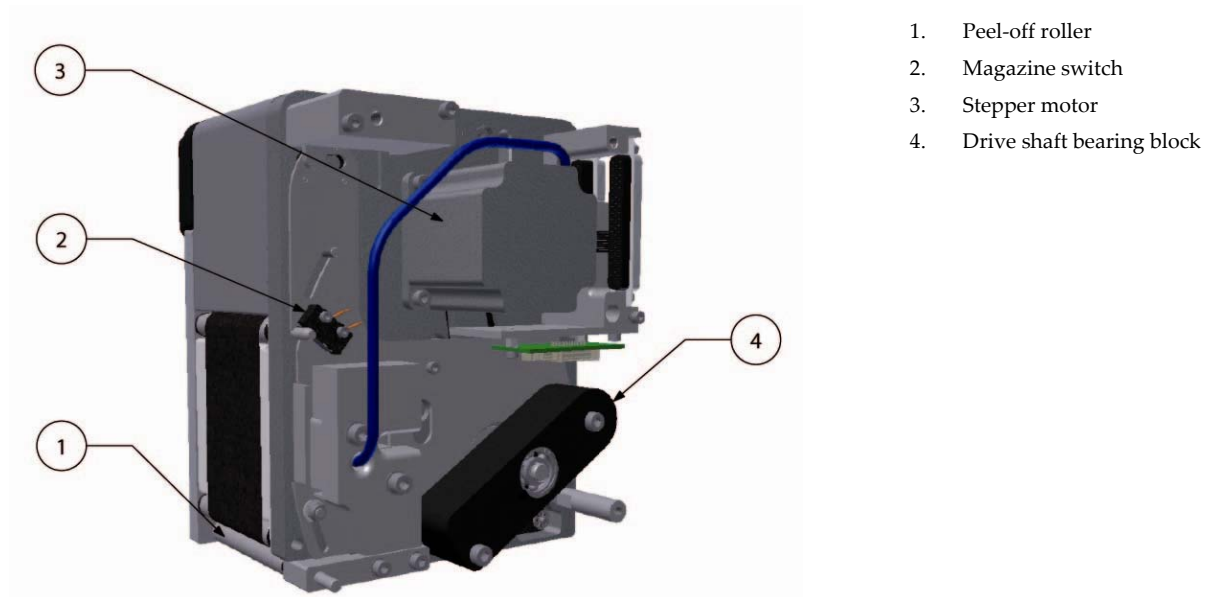

Fig. 2.5 Coding unit, interior parts back

The coding unit is available in a right hand (cR) and left hand (cL) version. The selection of the coding unit depends on the direction in which the substrate is moving. The direction of the movement is determined while facing the front of the printer and assuming the printer is printing downwards. When the substrate is moving from left to right a cR-model is required, see

Fig. 2.6. When the substrate is moving from right to left a cL-model is required.



Fig. 2.6 Coding unit model selection

The QiC 53c printing system comprises several key components.

The printer body contains all the mechanical and sensors necessary to drive the printhead and index the ribbon. The printer body connects to the control unit and supports the magazine.

The magazine is fitted to the printer body and guides the ribbon during printing. It is easily removed and stable when placed on a flat surface during ribbon changes.

Spare magazines can be used for very fast changeovers (e.g. during a production run) if required.

## 2.3 Control unit

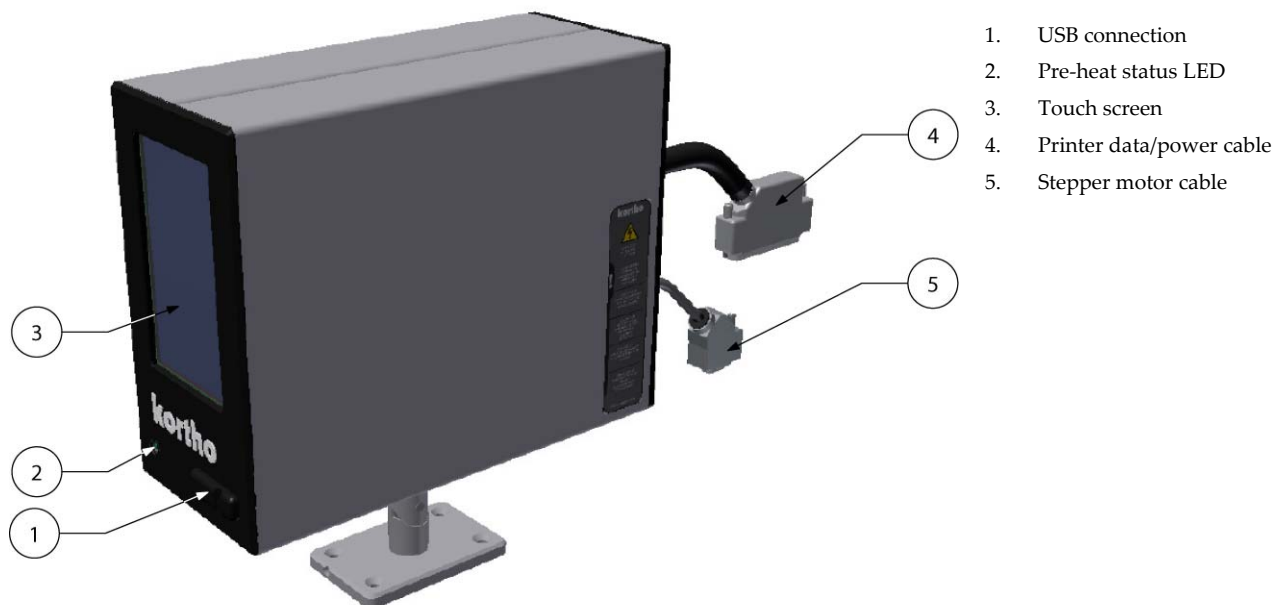

Fig. 2.7 Control unit + adjustable support

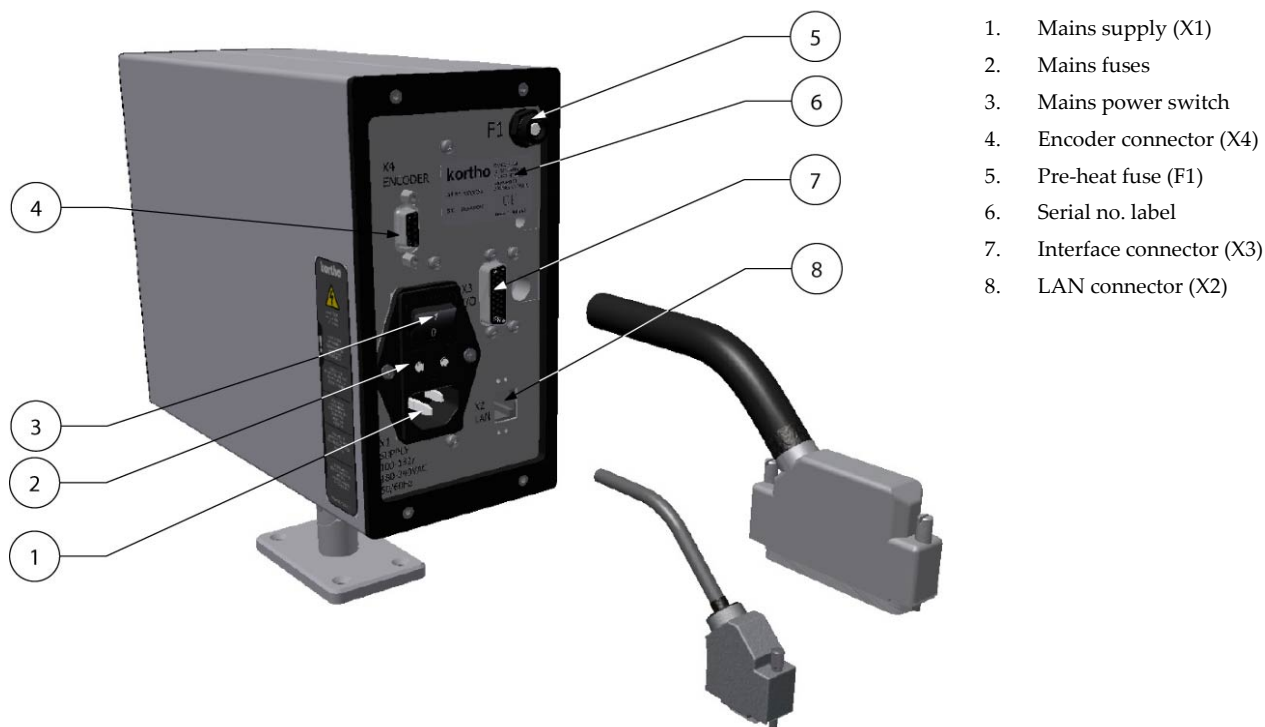
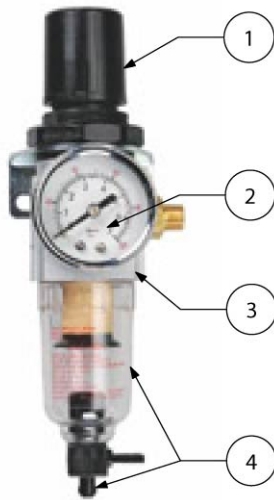

Fig. 2.8 Control unit, connections

## 2.4 Air supply

The printer requires an air supply that is clean and dry (ISO 8573-1:2010 [4:4:3]). Depending on the printspeed, substrate, ribbon used and the environmental conditions the air pressure should be set to value between 0,1 and 0,2MPa (1 and 2 bar).



1. Pressure regulator
2. Pressure gauge
3. Air distribution manifold
4. Water separation bowl with a manual drain valve

Fig. 2.9 Air regulator

## 2.5 Label design

A label can be designed by QiC Draw or Nicelabel in combination with the Windows driver. Other software can be used in combination with the Windows driver, but depending on the software, most internal functions will not be available. Please consult Korthofah or your local distributor for further information.

### 2.5.1 QiC Draw label design software

The label design software is called QiC Draw.

With this software package one can create labels for the QiC printer series. Besides the label design options, the program also offers several service diagnostic tools. It runs on an IBM-compatible PC with Microsoft Windows NT, 2000, XP, 7 or 8 installed.

For full details on installing and using the package, see the separate QiC Draw manual.

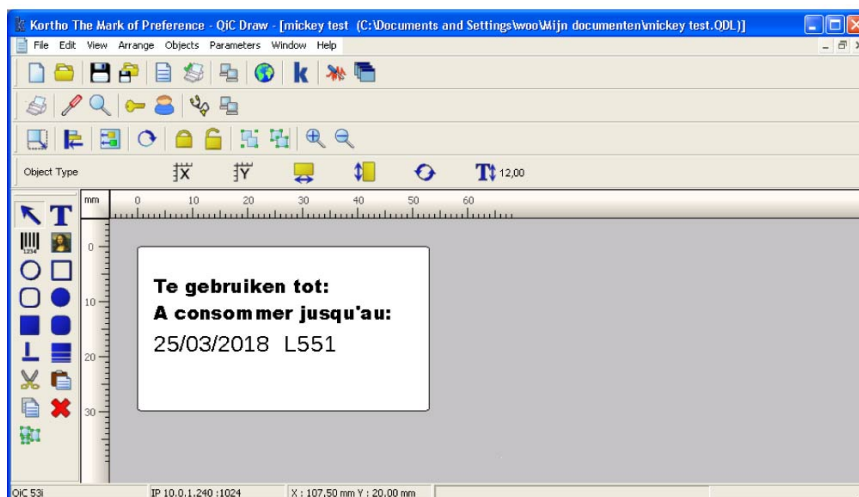

Fig. 2.10 QiC Draw main window

## 2.5.2 NiceLabel

Labels can also be created by using NiceLabel or any other windows based program using the Kortho printer driver for NiceLabel. When using this driver in combination with the NiceLabel software one can use the full options this software program offers including variable text and data field. One should note that using the NiceLabel Windows driver in combination with any other program will limit the label item options to fixed items. For information about the installation of the driver and the use of the NiceLabel, see Appendix E.

# 3 PRINT PROCESS DESCRIPTION

## 3.1 Print cycle

The purpose of the printer is to print a label on a substrate. A label is digital data and is stored in the print memory of the control unit. The control unit converts the label into a bitmap. The printhead receives this bitmap pixel-column by pixel-column and uses it to fire the heating elements of the printhead.

The ribbon that is placed between the printhead and the substrate is heated by the printhead heating elements. While a heating element is hot, the pigment of the locally heated ribbon will be transferred onto the substrate. By firing the heating elements in the right sequence the selected label will be printed on to the substrate.

The printhead contains 640 heating elements (12 dots per mm at a printhead width of 53,3mm). The vertical resolution is controlled by an encoder that is placed on the substrate and is also 12dots per mm.

The print cycle is initiated with a "print request" signal. The print request signal can e.g. be generated by a spot photocell, a relay switch or a PLC inside the host machine.

Once the print request signal is received by the control unit, the following sequence will be started:

1. Ribbon is brought up speed.
2. Printhead down.
3. Firing of the heating elements in the sequence determined by the label bitmap.

When the print is completed:

4. Printhead up.
5. Ribbon is slowed down.
6. Ribbon use will be calculated and based on that the ribbon will be rewound. In this way a minimum gap between the prints will be realised.

When a print has been made, the bitmap will be updated, if necessary, for variable label items such as time, date and number items. When this is done, the Busy output is de-activated and the printer is ready for the next print request.

## 3.2 Printhead

The printhead has high productivity and reliability by using its unique face-down IC bonding method instead of the conventional wire bonding method. It is seen in a range of industrial coding and marking applications, as a versatile technology able to print on a wide variety of substrates.

The printhead consists of an alumina ceramic base plate. This base plate is covered by a glass layer, a heaterline layer and finally an abrasion-resistant ceramic coating. The structure and materials chosen guarantee a high quality print and an optimal life time of the printhead.

For making a high quality print with the printhead it is important that:

- The right amount of energy is applied to the heating elements (customer setting).
- The pre-heat is set to the optimum value (customer setting).
- The printhead, with the ribbon and substrate in between, is pressed against a platen roller with the right force.
- The ambient temperature is between 5 °C - 40 °C (41 °F - 104 °F).
- The ribbon and the substrate are matched. Various ribbons are available each with its own specific characteristics.
- The environment and especially the substrate is clean. Some materials, like small hard particles, can damage the printhead. Due to this white lines will appear in the print. This type of damage is permanent.
- The printhead maintenance, refer to section 10.1.1. Important factors in regards to this are:
  - **Abrasion:** the process of wearing down by friction—will occur during normal operation of the printer. However, it can be minimized through proper care and maintenance and by using a high quality ribbon.
  - **Contamination:** when particulate matter—such as dust—damages the printhead, it becomes contaminated.
  - **Corrosion:** Gradual deterioration of the printhead may occur because of the substrate used, incorrect cleaning agents or the environment.
  - **Electrostatic Discharge (ESD):** Electrostatic discharge may occur due to improper handling, charging of non-conductive substrate and ribbon moving through dry air.
  - **Moisture:** If your printer is operating in a humid or damp environment, this moisture may damage the printhead.
  - **Residue:** The buildup of residue—or foreign materials—may occur with improper maintenance, incorrect cleaning agents, inferior substrate or incorrect application setup. Aggressive cleaning requires the use of Kortho's specially-formulated cleaning swabs.

### 3.3 Coding unit

The coding unit can be positioned in almost any position. When positioning the system it is important to make sure the magazine is facing the operator for easy access and clear view on the indicators.

### 3.4 User interface

The user interface on the control unit consists of a touch panel displaying the menu structure of operator menus and a LED indicator showing whether the system is preheating the printhead. Beside this, a multifunctional button (test print/ reset error/reset ribbon length) and 2 LED indicators are present on the coding unit.

The touch panel consists of a resistive touch screen and a TFT panel. For accurate operation it is important to apply the pressure on a relatively small area e.g by using a stylus. To prevent using a stylus all the time, the user interface has been optimized for finger touch.

#### 3.4.1 Menu structure

The screen is divided in three parts, see Fig. 3.1. Section 1 shows the submenus available when the printer icon is selected. When the other icons in section 3 are selected, different submenus will be shown. Section 2 is showing the status of the printer and the Start (I) \ Pause (O) button. Depending on the button selected in section 1 and 3 the content of this section will change.

## PRINT PROCESS DESCRIPTION

The content can be settings, status information or general information. Section 3 is showing the 4 main menu options:

1. Label selection/Label management.
2. Printer settings.
3. Diagnostics.
4. Information.

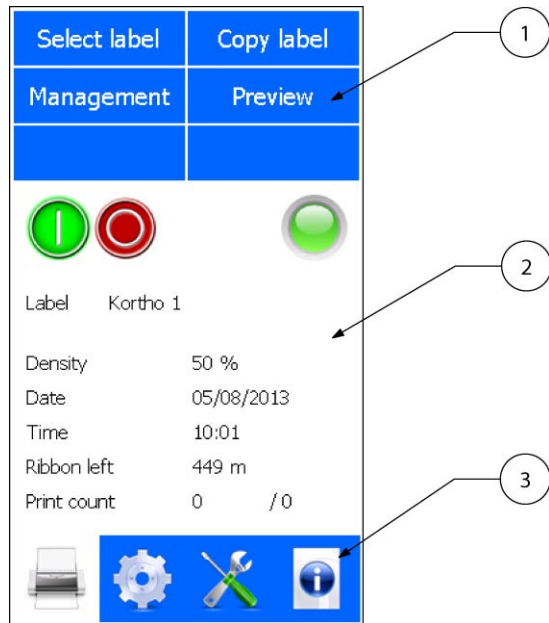

1. Section 1, sub menu items
2. Section 2, status or options
3. Section 3, main menu items

Fig. 3.1 Screen layout, main menu portrait

The standard factory setting for the menu is portrait mode. Alternatively the screen can be displayed in landscape mode. The screen can be rotated by steps of 90 degrees, see section 8.6.1.

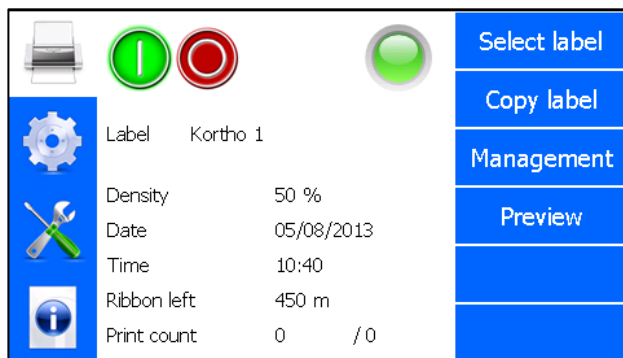

Fig. 3.2 Screen layout, main menu landscape

### 3.4.2 LED indicators on control unit

The status screen of the control unit shows a LED indicator which is showing the same as the status LED on the coding unit, see section 3.4.3.

The green LED indicator, on the front bottom left corner of the control unit enclosure, indicates whether the heating element for preheating the printhead is energised (heating). When starting up the printer, the LED will light continuously.

When at temperature, the LED will start flashing. If the LED remains off during printing, the temperature of the thermal printhead is above the set temperature of the preheat setting.

The thermal printhead produces heat, so if the system is printing a lot, the printhead will be heated by the energy it produces and the preheating system simply shuts down.

### 3.4.3 LED indicators and front button on coding unit

There are two LED indicators and a single front button mounted on the coding unit. This is particularly useful for operators during the replacement of ribbon or solving a ribbon break as all the necessary controls are located above the magazine.

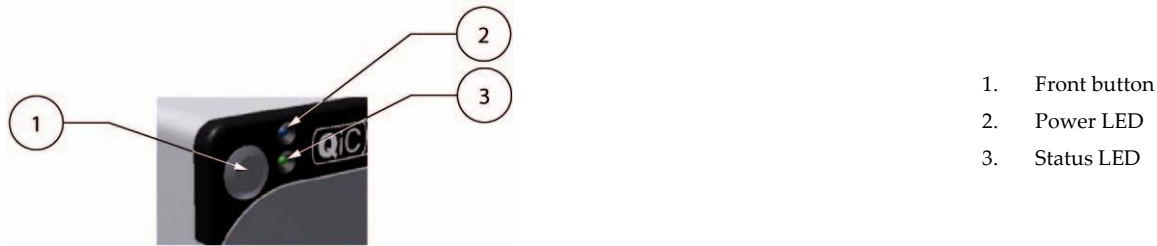

Fig. 3.3 LED indicators and front button

The front button has several functions:

- Following a ribbon break, printer malfunction or head being lifted: pressing the front button will attempt to reset the condition. However, if the condition remains e.g. the ribbon breakage is not recovered, then the button will not reset the printer.
- If the printer is ready to print i.e. label loaded, head locked and no printer fault: pressing the front button will trigger a single print when the system is set in pause mode.
- After placing a new roll of ribbon: pressing and holding the front button for about 4 seconds will reset the ribbon left value to the length of a full roll.
- After a firmware update or if the system is not responding properly: pressing the front button while switching on the printer will reset most of the variables to the factory setting. To reset the control unit:
  1. Press front button.
  2. Switch on the control unit and keep front button pressed
  3. When the status led starts flashing, release the front button.

The Power LED shows if the 5VDC is present in the coding unit

The Status LED displays several conditions:

- Constant green: System ready for printing.
- Blinking green: No label loaded.
- Fast blinking green: Internal data communication activity.
- Constant orange: Ribbon break, head unlocked or printer fault.
- Blinking orange: Low ribbon warning.
- Blinking red/orange: System reset

### 3.4.4 Keyboard

Data and settings can be entered through a keyboard that will be displayed on the TFT panel.

The keyboard has four screens. The first screen is shown below. The tiny round indicators at the bottom of the screen show which of the four keyboard screens is currently displayed. One can select another keyboard by either using the relevant buttons or by swiping over the round indicators at the bottom of the screen.



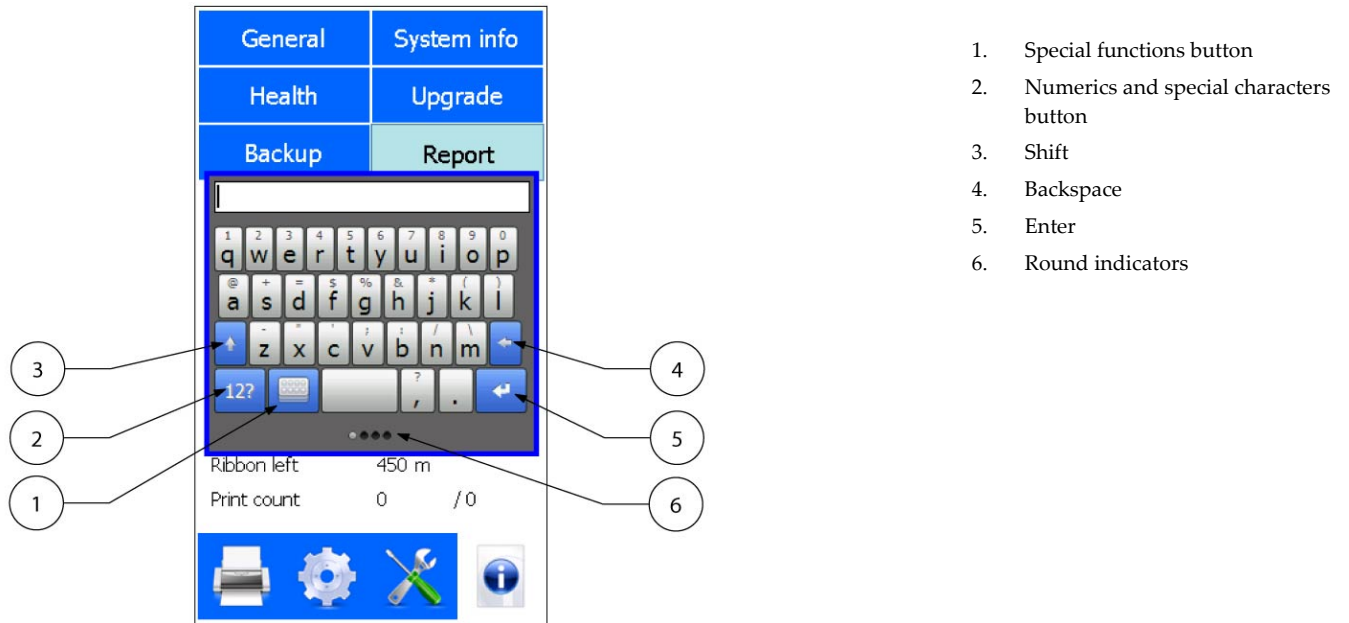

Fig. 3.4 First keyboard screen

To use the keyboard superscript alphanumerics:

1. Touch and hold the desired key.
2. Drag your finger to the small menu that appears with a choice of alternative characters.

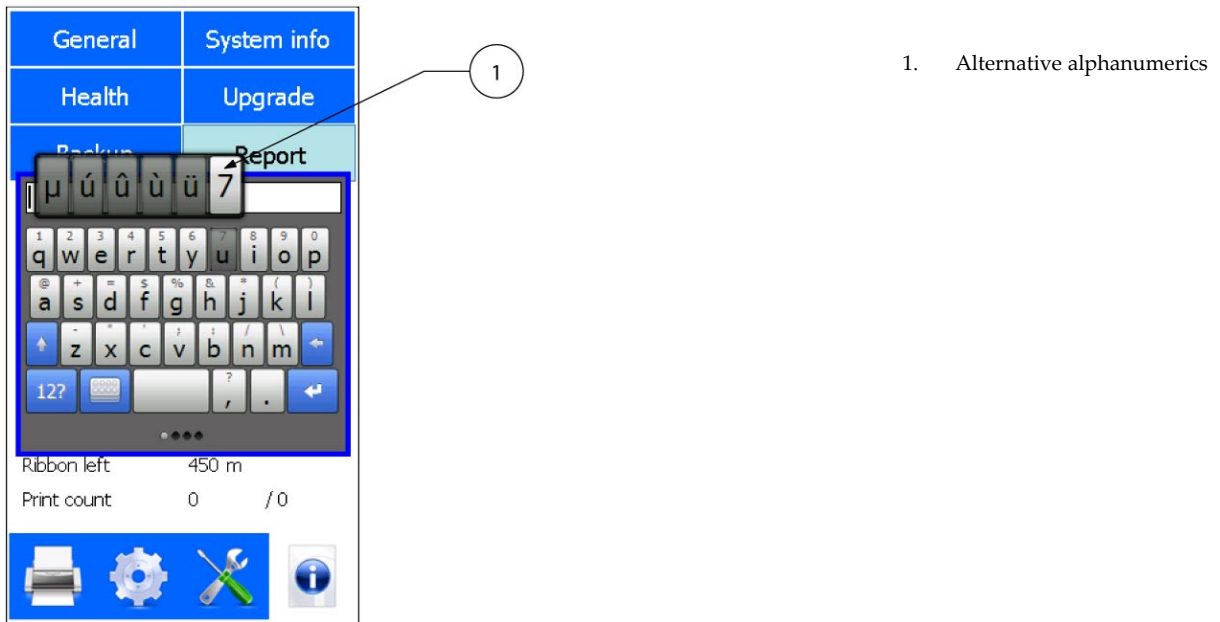

Fig. 3.5 First keyboard screen, alternative alphanumerics

An alternative way to select a digit is to touch the numerics and special characters button. The second keyboard screen will appear.



Fig. 3.6 Second keyboard screen, numerics and special characters

For entering commonly used text the third keyboard screen can be used. One can store frequently used texts in this keyboard. To enter this screen either swipe over the round indicators at the bottom of the screen or touch the special functions button in the first screen to enter the fourth screen and touch FX.

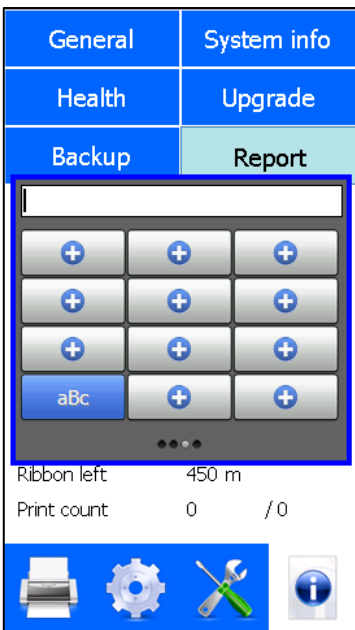

Fig. 3.7 Third keyboard screen, commonly used text

To program the buttons in the third screen:

1. Touch the special functions button on the first keyboard screen.
2. Touch the *FX* button.

The screen as shown in Fig. 3.7 will appear.

3. Touch one of the + buttons and enter the data to be stored, see Fig. 3.8.

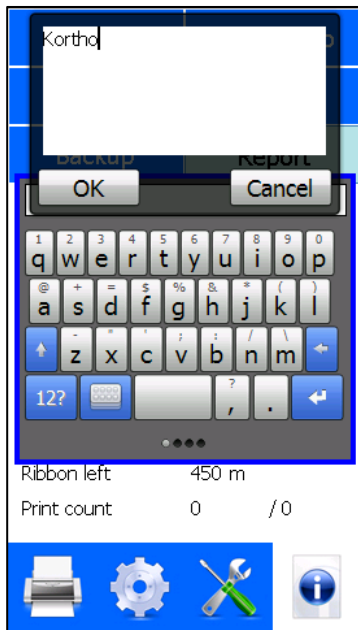

Fig. 3.8 Programming third keyboard screen buttons, entering text

4. Touch the **OK** button to store the text.

The button is now labelled with the text entered, see Fig. 3.9. Touching this button enters the text where required.



Fig. 3.9 Programming third keyboard screen buttons, entering text

The text in a button can be deleted or modified later on.

A text placed by using the third keyboard screen will be treated as normal text, so the text can be deleted or modified if required.

## PRINT PROCESS DESCRIPTION

To edit text and use cursor controls, touch the keyboard button. This following screen will appear:

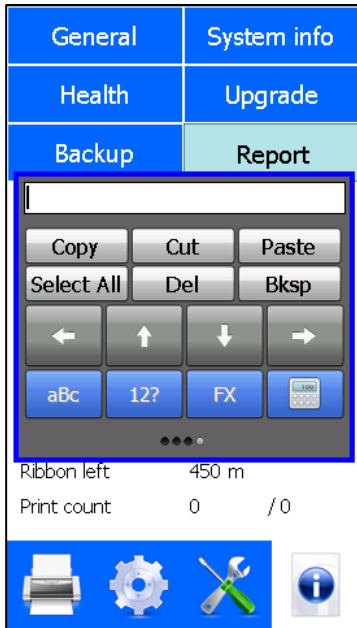

Fig. 3.10 Fourth keyboard screen, edit text and use cursor controls

To return to the first screen touch the *aBc* button.

To return to the second screen touch the *12?* button.

To return to the third screen touch the *FX* button.

Beside the standard keyboards there is a numeric keyboard available for all numeric items/entries, see figure Fig. 3.11.

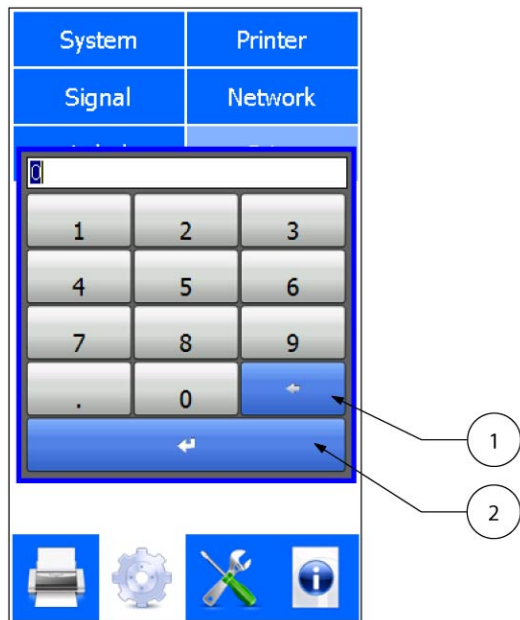

1. Backspace
2. Enter

Fig. 3.11 Numeric keyboard

### 3.4.5 System information

The firmware versions installed on the controller can be displayed on screen by pressing *System Info* in the Information menu.

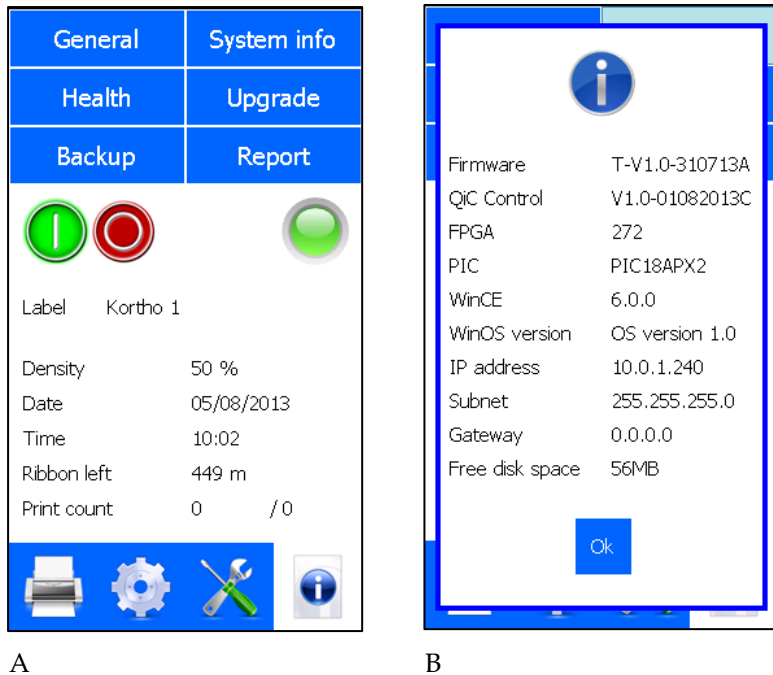

Fig. 3.12 Entering the System information screen

### 3.4.6 Menu structure

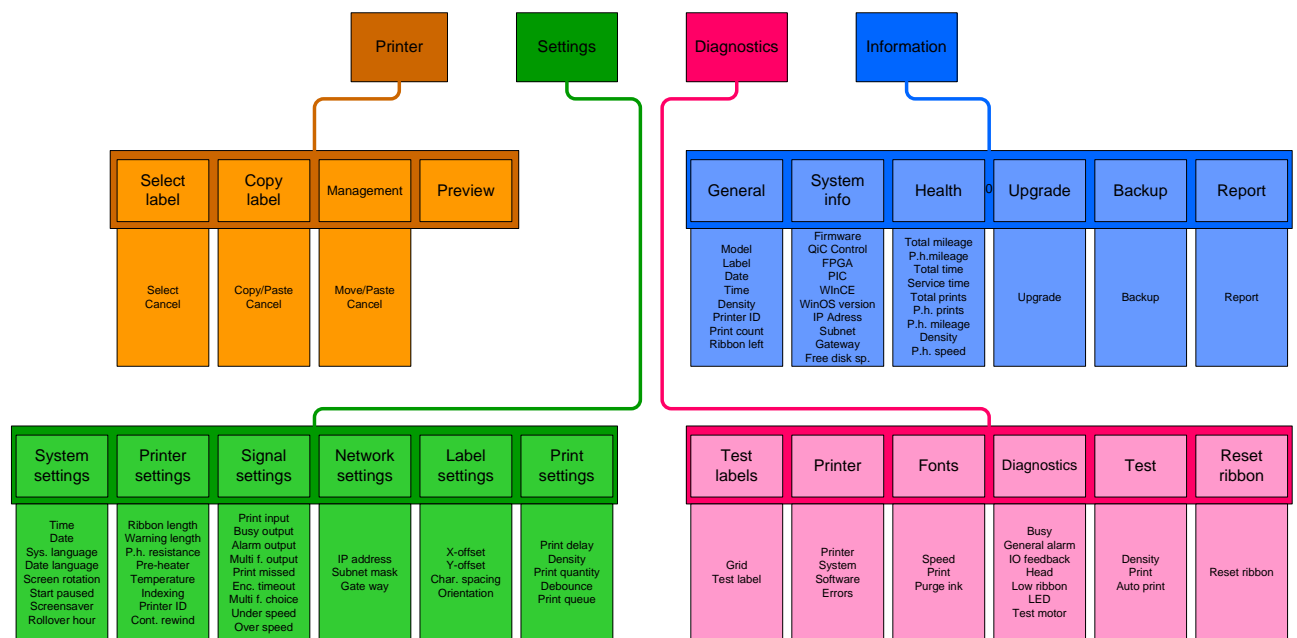

Fig. 3.13 Standard menu structure

Refer to Appendix E for a full-scale sheet of the menu structure..



# 4 SAFETY

This product is designed to conform to all applicable directives, and their relevant harmonized standards, of the European Council.

## 4.1 Control unit

### 4.1.1 General information



Fig. 4.1 Control unit identification label

The contact details of Korthofah can be found on the identification label which is located at the back of the controller. Also the part number and serial number of the control unit can be found here. The coding unit has its own part number and serial number. The coding unit identification label can be found inside the coding unit.

### 4.1.2 Power supply

For safe operation, the power cable to the control unit must be connected to a properly grounded single-phase supply of the appropriate voltage. The power supply must comply with the power supply information that is written on the back of the control unit, see Fig. 4.2, refer to Appendix A.



1. Power supply label

Fig. 4.2 Power supply information

Verify that no significant potential difference exists between the single-phase ground supply of the printer and the frame ground of the host machine.

## SAFETY

---

The wire colour code for the supply cable is:

- BROWN for Line (L)
- BLUE for Neutral (N)
- GREEN/YELLOW for Protective Earth (PE)

When installing or servicing the equipment ensure that the host machine is stopped.



### Note:

All external equipment that is connected to the control unit interface must be double insulated to qualify the whole installation as a separated extra-low voltage (SELV, Class II) system.

### 4.1.3 Precautions before power-up

Check at every printer power-up if all these connections are secured:

1. The cable/conduit between the control unit and the coding unit.
2. The mains power plug. (X1).
3. The air connection (on the coding unit).
4. The encoder. (X4).
5. The interface cable. (X3). (Info: host-interface).
6. The LAN cable (X2). (Option).

### 4.1.4 Precautions when opening the control unit



1. Attention label

Fig. 4.3 Attention label for opening control unit

The control unit side cover has an attention label (Fig. 4.3) to alert the user to read the manual before opening the control unit.

**ALWAYS** disconnect the power to the control unit before removing any connectors or covers:

- Switch off the control unit.
- Remove the plug from the mains power supply.
- **DO NOT** operate the printer when any cover is removed.
- **DO NOT LEAVE** tools, screws or other parts inside the control unit when re-assembling the equipment.
- **USE** all four screws to fasten the covers.



## **4.2 Anti-static precautions**

### **4.2.1 Printhead**

The printhead is a static sensitive device, which can be damaged if it is touched without the necessary electrostatic discharge (ESD) precautions being taken. The ESD precautions involve the use of a grounded wrist strap and/or conductive work mat.

During installation, servicing and handling of the printhead, the printhead must be protected from electrostatic discharges. The printhead can be compared with a normal CMOS circuit and must be ESD protected accordingly to avoid later problems caused by discharges.

### **4.2.2 Printed circuit boards**

The printed circuits boards can be damaged if they, or the connectors connected to the printed circuit board, are touched without the necessary electrostatic discharge (ESD) precautions being taken. The ESD precautions involve the use of a grounded wrist strap and/or antistatic work mat.

During installation, servicing and handling of a printed circuit board it must be protected from electrostatic discharges.



# 5 TRANSPORT & STORAGE

## 5.1 Printer equipment

### 5.1.1 Shipping and handling

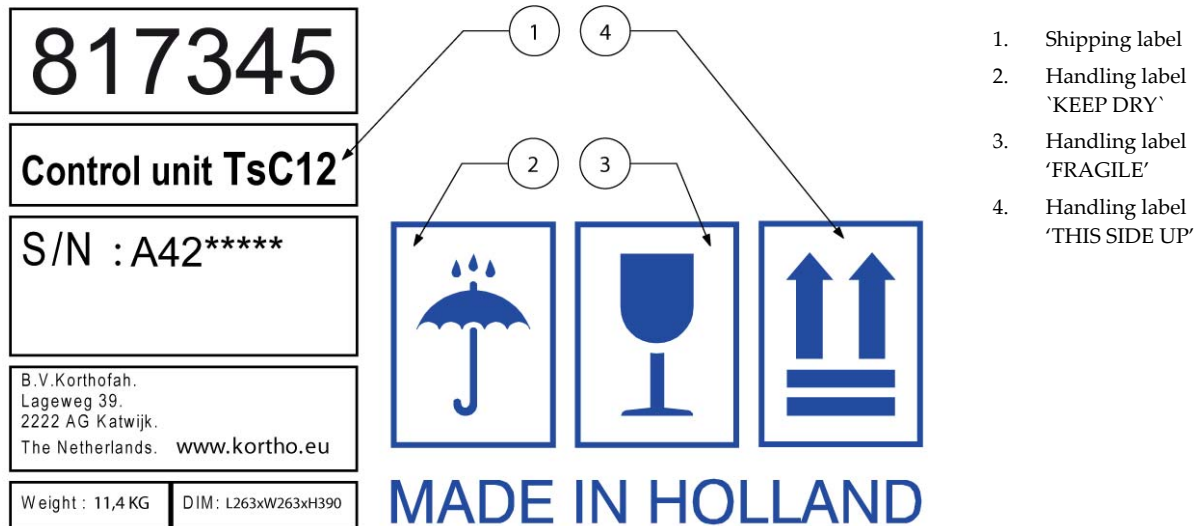

Fig. 5.1 Shipping and handling labels

The original packaging for the QiC 53c set is labelled with similar shipping and handling labels as shown in Fig. 5.1. The handling labels must be visible from all sides.

- Refer to label (1) of Fig. 5.1 for shipping information.

Description	Part number	Weight	Dimensions (cm)
Coding unit 53cL	816559	7,3 kg	L280 x W280 x H340
Coding unit 53cR	816378	4,5 kg	L280 x W280 x H340
Controller TsC12-c	817345	4,5 kg	L263 x W263 x H390

- Store the package in a dry location, refer to label (2) of Fig. 5.1.
- Handle the package with care, because the printhead is fragile. Refer to label (3) of Fig. 5.1.
- Keep the package upright in all cases refer to label (4) of Fig. 5.1.

### 5.1.2 Pre-transport procedure

The transport distance and time is determinative for the pre-transport procedure:

#### For movement within a building:

1. Keep the coding unit upright with the printhead in its upper position to avoid the printhead gets damaged during the transport.
2. Avoid shocks and vibrations during the transport.

### For movement from building to building:

1. Keep the coding unit upright with the printhead in its upper position to avoid the printhead gets damaged during the transport.
2. Avoid shocks and vibrations during the transport.
3. Use original or equal packaging for the printer equipment.
  - a. Label the box with 'keep dry' labels like label (2) of Fig. 5.1 (visible at all sides).
  - b. Label the box with 'fragile' labels like label (3) of Fig. 5.1 (visible at all sides).
  - c. Mark the top of the box with 'this side up' labels like label (4) of Fig. 5.1 (visible at all sides).

### 5.1.3 Pre-storage procedure

The printer storage location and time is determinative for the pre-storage procedure:

#### When still mounted on the support but idle for at least one month:

1. Keep the coding unit upright with the printhead in its upper position to avoid the printhead gets damaged.
2. Avoid shocks and vibrations during the transport.
3. Place a dust cover or bag over the coding unit.
4. Place a dust cover or bag over the control unit.

#### For storage prior to distribution:

1. Keep the coding unit upright with the printhead in his upper position to avoid the printhead gets damaged during the handling and the transport.
2. Avoid shocks and vibrations during the handling and the transport.
3. Store in the original or equal packaging.
  - a. Label the box with 'keep dry' labels like label (2) of Fig. 5.1 (visible at all sides).
  - b. Label the box with 'fragile' labels like label (3) of Fig. 5.1 (visible at all sides).
  - c. Mark the top of the box with 'this side up' labels like label (4) of Fig. 5.1 (visible at all sides).
4. Store the printer, in the original or equal packaging with topside upwards, in a dry place at ambient temperature between 5 °C and 40 °C.

## 5.2 Ribbon

Refer to the latest Material Safety Datasheet for more detailed and accurate information.

The regulations relating to storage premises also apply to workshops where the product is handled.

## 5.2.1 Handling and storage

**Handling**

- : As with all chemicals, good industrial hygiene practices should be followed when handling this material.  
Always wash hands thoroughly after handling and before eating, drinking, or using tobacco products.  
Avoid inhalation of ink particles, in case of flaking.

**Storage**

- : Keep in a dry and cool place.

**Specific use(s)**

- : Use only as a marking tool to indentify products.

## 5.2.2 Transport information

Refer to the latest Material Safety Datasheet for more detailed and accurate information.

The product is not subject to transport regulations (ADR/RID, IATA and IMO).

Keep the ribbon in a closed box in a dry place and cool place. This is valid for all kinds of transport.



# 6 INSTALLATION

## 6.1 Requirements

### 6.1.1 Provided by the customer:

- Power: 90-132VAC / 180-264VAC, 47 - 63HZ - including clean protective earth.
- A print request-signal (e.g. output of the host machine or a photocell signal).
- Sufficient space for installation and operation.
- Compressed air, dry and oil free, with an adjustable pressure between 0,1 to 0,3 MPa at the printer (stable; depending on the printspeed, substrate, ribbon used and the environmental conditions). Input to the air regulator should be 0,7 MPa to 0,8 MPa. Distance between regulator and printer should be as short as possible and no longer then 3m. The air connection on the coding unit has an outer diameter of 6mm and an inner diameter of 4mm. The minimum inner diameter of the air tubing must be 4mm.

#### Optional:

- An error input on the host machine. This will stop the host machine when the printer reports an error (general printer alarm).
- A warning-signal input on the host machine (warning alarm).
- A busy-signal input on the host machine. So the host machine can detect that the printer is in a print cycle (printer busy).

**Note:**

Refer to Appendix D, Connections, for the connection options.

### 6.1.2 Equipment

- Coding unit, see section 6.2.1.
- Control unit, see section 6.2.1.
- Printer bracket, see section 6.3.1 and 6.3.2.
- Air reducer, see section 6.3.4.

## 6.2 Unpacking

### 6.2.1 Coding unit QiC 53c

The coding unit consist of two main parts, the printer body that hold the printhead and the magazine that holds the ribbon.

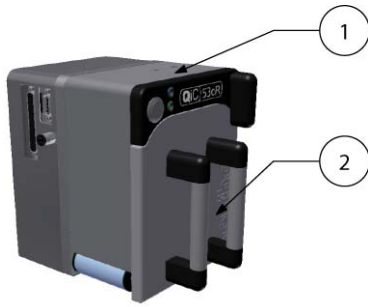

1. Coding unit
2. Cassette

Fig. 6.1 Coding unit QiC 53c

### 6.2.2 Control unit TsC12

The control unit is used for controlling the coding unit and holds the labels. The control unit can be mounted with the bracket which is supplied with the control unit.

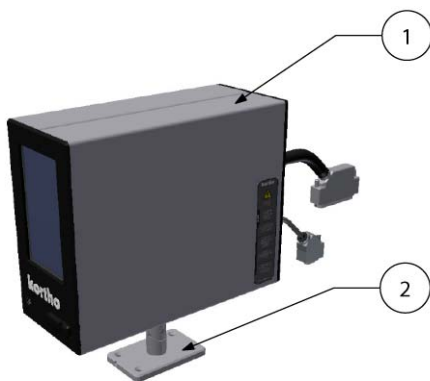

1. Control unit with mains power cord
2. Bracket
3. Manual (on USB thumbdrive - not shown)

Fig. 6.2 Control unit TsC12

### 6.2.3 Printhead cleaning set

The cleaning set (167131) consists of a box with 25 cleaning swab sticks for cleaning the thermal printhead (each swab contains cleaning liquid). Break the hollow stick to moisten the swab.



## 6.3 Mounting the coding unit

### 6.3.1 Coding unit mounting support

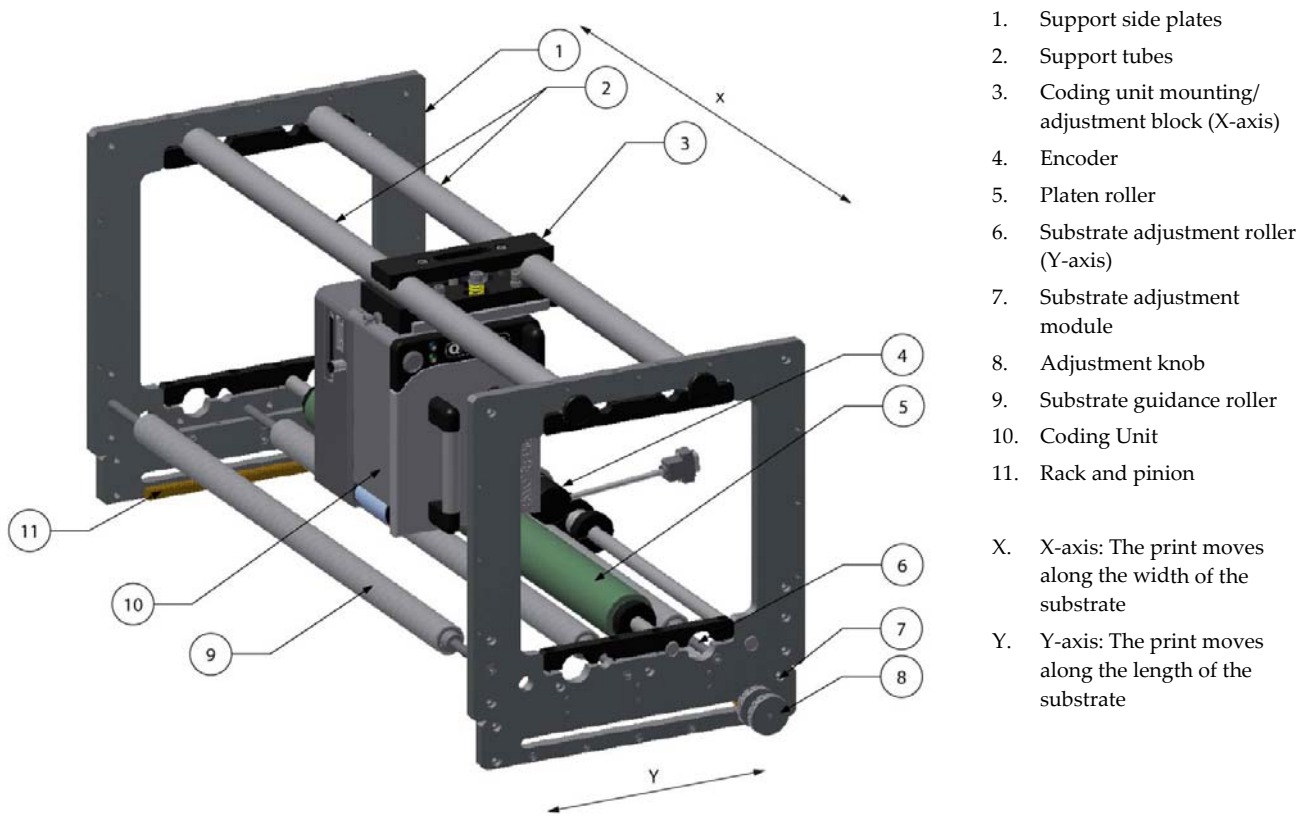

1. Support side plates
  2. Support tubes
  3. Coding unit mounting/adjustment block (X-axis)
  4. Encoder
  5. Platen roller
  6. Substrate adjustment roller (Y-axis)
  7. Substrate adjustment module
  8. Adjustment knob
  9. Substrate guidance roller
  10. Coding Unit
  11. Rack and pinion
- X. X-axis: The print moves along the width of the substrate
- Y. Y-axis: The print moves along the length of the substrate

Fig. 6.3 Positioning of the print

Assuming a mounting support is available:

1. Find a suitable location on the host machine for mounting the coding unit.
2. Make sure this location does not prevent people doing their job and that this location is accessible for operating the printer and for maintenance.
3. Make sure there is enough tension on the substrate to keep it in close contact with the platen roller. For an accurate speed measurement and a good print result, the substrate may not slip over the platen roller.
4. Mount the substrate adjustment module on the mounting support (substrate runs first under the coding unit, then second through the substrate adjustment module and then to the seal area of the host machine).
5. Mount the coding unit mounting support on the host machine.
6. Fit the coding unit to the mounting/adjustment block.
7. Fit the coding unit with adjustment block on the support tubes.
8. Slide the coding unit to the position (X-axis) where the print should be printed.
9. Tighten the mounting screws of the coding unit adjustment block.

### 6.3.2 Encoder

Assuming a mounting support is available:

1. Slide the encoder bracket on the encoder shaft while placing the encoder shaft in the mounting support.

2. Secure the encoder shaft.
3. Move the encoder into position:
  - a. Preferable the encoder should be placed on the substrate as close as possible to the printhead.
  - b. Alternatively place the encoder on the platen roller..
4. Tension the bracket spring and lock the encoder into position.

The tension on the encoder should be just enough to prevent the encoder wheel from vibrating and losing contact with the substrate and/or platen roller. If the pressure is set to high, there is a chance of extensive wear of the encoder bearings.

### 6.3.3 Substrate adjustment

The print position can be moved with the substrate adjustment roller, Fig. 6.4 item 3, between the top and bottom of the package. Be aware that the substrate contains an amount of prints/packages between the print area and the seal area. So a substrate adjustment takes only effect after a certain amount of prints.

Alternatively one could use the setting, see paragraph 8.6.6, to position the print. Be aware that by using the delay there is a chance that the packaging machine will stop between receiving the print request signal and making the actual print. In this way a print request signal might get lost, due to which one package will not be coded.

The package length must be smaller than twice the rack and pinion length ( $L_y$ ) of substrate adjustment roller package length. The print area can only then be positioned anywhere between the top and bottom of the package.

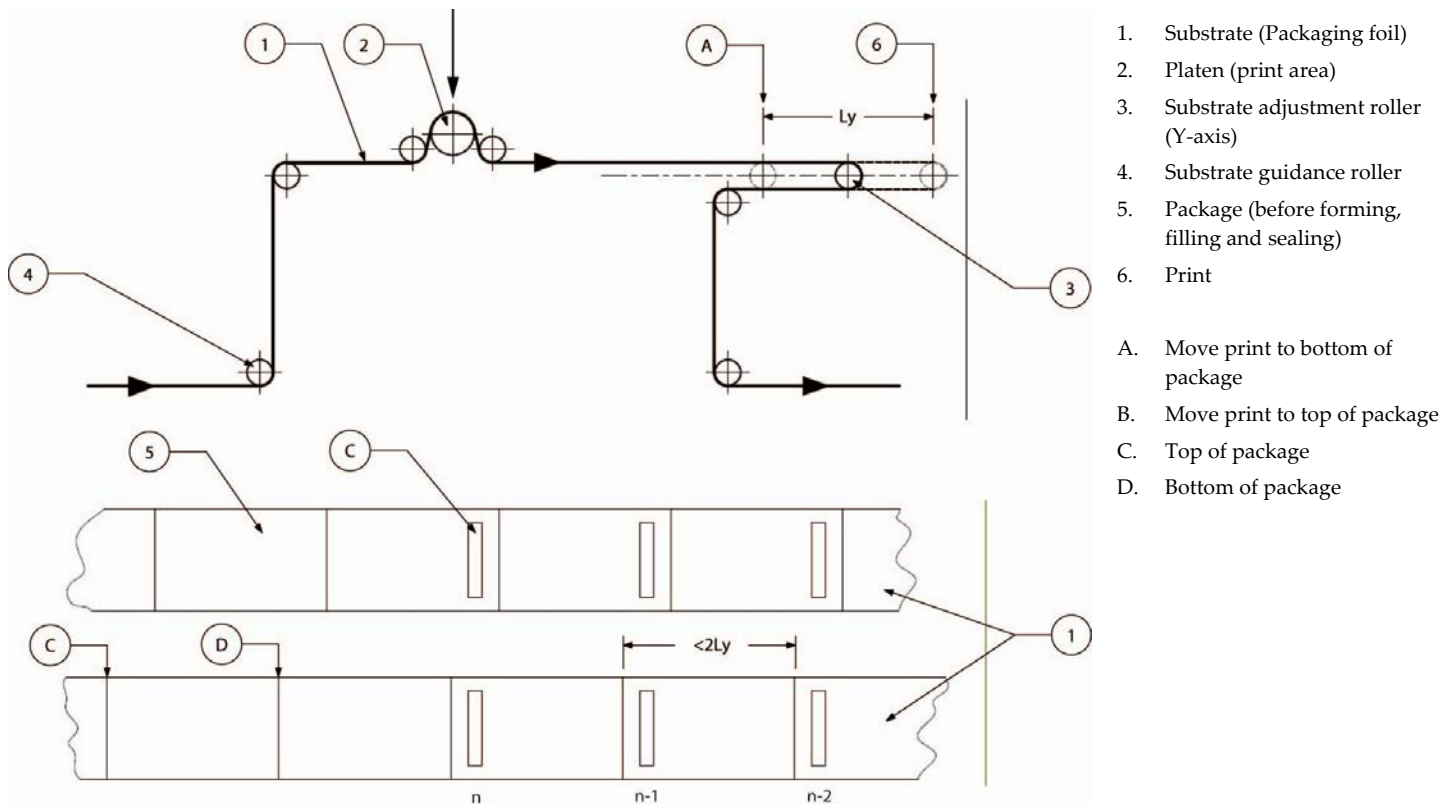

Fig. 6.4 Substrate adjustment.

Another reason for mounting a substrate adjustment is to move the moment of printing to a moment at which the substrate speed is stable. As big variations in speed can influence the print quality it is advisable not to print while the substrate is speeding up and slowing down.

### 6.3.4 Air supply

1. Place and connect the air regulator to the air supply and the coding unit.
2. Adjust the pressure between 0,1 MPa and 0,2 MPa (Stable; Depending on the printspeed, substrate, ribbon used and the environmental conditions).

## 6.4 Mounting the control unit

1. Find a secure location, which is easily accessible for operators, to mount the control unit. Refer to Appendix B, Dimensions Control unit for the dimensions of the mounting holes.
2. Locate the control unit on a position near the coding unit bracket and install the cables so that the coding unit can move back and forth within the dimensions of the bracket.
3. Check whether all of the cables are long enough to be connected to the connectors on the back of the control unit. If not, correct it by relocating either the coding unit or the control unit and/or extend the cable(s) if possible (the cable between the coding unit and control unit should not be extended).
4. Connect the interface cable to the host machine. Use the electrical diagram, Appendix D X3 Circuit diagram (input) and X3 Circuit diagram (output), to determine which interface option suits best with the host machine.
5. Connect the interface cable to the interface port (X3).
6. Connect the control/data cable, between the control unit and the coding unit (fixed length).
7. Connect the encoder cable (X4).
8. Connect the control unit to the local network if required (X2 - optional).
9. Connect the mains supply (X1).



# 7 COMMISSIONING

This part describes the commissioning of a typical printer application.

## 7.1 Initial setup

### 7.1.1 Load the ribbon on the magazine

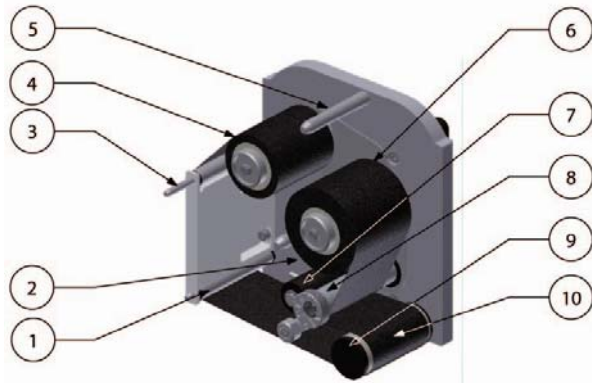

1. Ribbon guide roller
2. Ribbon path label
3. Magazine locking pin
4. Rewind spool
5. Guide post
6. Feed spool
7. Pressure roller with lever
8. Ribbon drive roller
9. Ribbon sensor roller
10. Pigmented (matt) side of the ribbon

Fig. 7.1 Ribbon magazine.

1. Check and clean the ribbon sensor roller, the ribbon drive roller and the pressure roller.
2. Place an empty core on the rewind spool (4), check whether the pin slides in the notches of the empty core.
3. Slide the new ribbon roll on the feed spool (6) (refer to the ribbon path label (2) in the magazine for the correct way to load the new roll; the matt side should face the substrate).
4. Open the pressure roller and guide the ribbon along the pressure roller/ribbon drive roller and ribbon sensor roller.
5. Guide the ribbon along the guide rollers (1).
6. Tape the end of the ribbon to the empty core and rotate the ribbon drive roller a few turns clockwise until the ribbon is tensioned.
7. Check whether the magazine handle is positioned in the open position.
8. Place the magazine in the coding unit. Use the guide post (5) to place the magazine properly .
9. Push the magazine into the printer body (against the spring pressure of the drive mechanism) and lock the magazine by pushing the magazine handle in and turning it in an anti-clockwise direction until positioned at 6 o'clock.

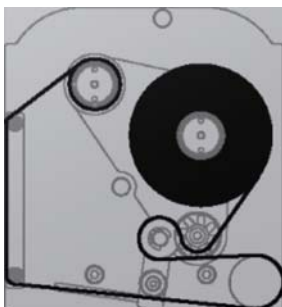

Fig. 7.2 Ribbon path label.

## 7.1.2 Aligning the printhead to the platen roller

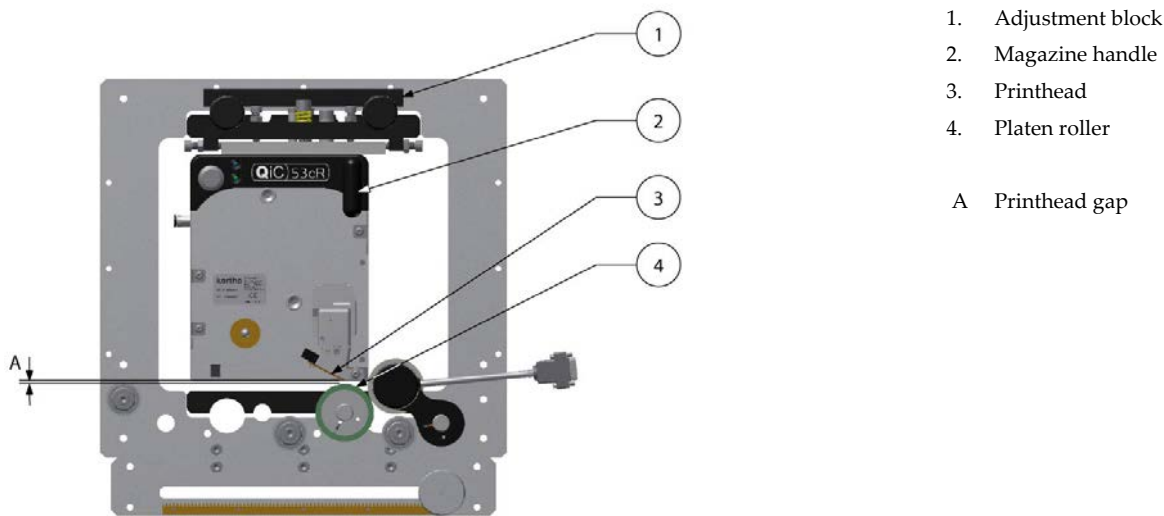

Fig. 7.3 Adjustment of printhead gap.

To achieve a good and equal print quality over the complete print area the distance between the printhead and the platen roller (the printhead gap) should be equal spaced (left and right side of the printhead). Besides this it is important that the printhead is positioned on the centre of the platen roller, see Fig. 7.3 (rather over the centre than before the centre – 1mm maximum - so best printhead position is as shown on the picture or just a bit more to the right).

Use the mounting/adjustment block to align the printhead to the platen roller (parallel and at the right height), see section 7.3:

1. Connect the Coding Unit to the air supply unit and apply pressure to the printhead.
2. Push (inward) and turn the magazine handle (2) to unlock the magazine.
3. Remove the magazine.
4. Loosen the lockscrew Fig. 7.4 (5) of the adjustment block.
5. Use the four adjustment screws to align the printhead parallel to the platen roller.
6. Loosen the lockscrew Fig. 7.4 (9) of the adjustment block.
7. Use the two adjustment screws Fig. 7.4 (4) and the lockscrew of the adjustment block to set the printhead on centre and in line with the platen roller.
8. Tighten the screws to secure the printhead position.
9. Tighten the two spring screws Fig. 7.4 (10) and then turn them 3 full turns anti-clockwise to loosen them a bit. This will result in maximum spring pressure while allowing adjustment during printing.
10. Use the four adjustment screws to set the gap (A). The gap should be as small as possible, about 1 mm.
11. Disconnect the air supply.
12. Push the printhead down and check whether it is horizontally aligned with the platen roller. If not, repeat step 4 to 11 and check again.
13. Place the magazine and lock it.
14. See section 7.3, for optimizing the print quality while printing.

## 7.2 Preparing the control unit

To setup the control unit for the first time:

1. Make sure the system is properly installed and all connections are secured, see sections 6.3, 6.4 and 7.1
2. Switch on the control unit and wait until the main menu appears.
3. Set the menu language, refer to section 8.6.1.
4. Set the date language, refer to section 8.6.1.
5. Set the time and date, refer to section 8.6.1.
6. Set the interface settings, refer to section 8.6.3.
7. Set the IP address, refer to section 8.6.4.
8. Set the printhead resistor value, refer to section 8.6.2.
9. Load a test label, refer to section 9.1.1.
10. Place a substrate between platen roller and printhead.
11. Touch the test button on the coding unit (make sure the system is paused first).
12. Check whether a print cycle is made (if not check trouble shooting).
13. Proceed with the next section, section 7.3.

## 7.3 Optimising the print quality

The quality of the print is determined by a combination of printhead pressure, printspeed, print density(contrast), preheat setting and alignment between printhead and the platen roller.

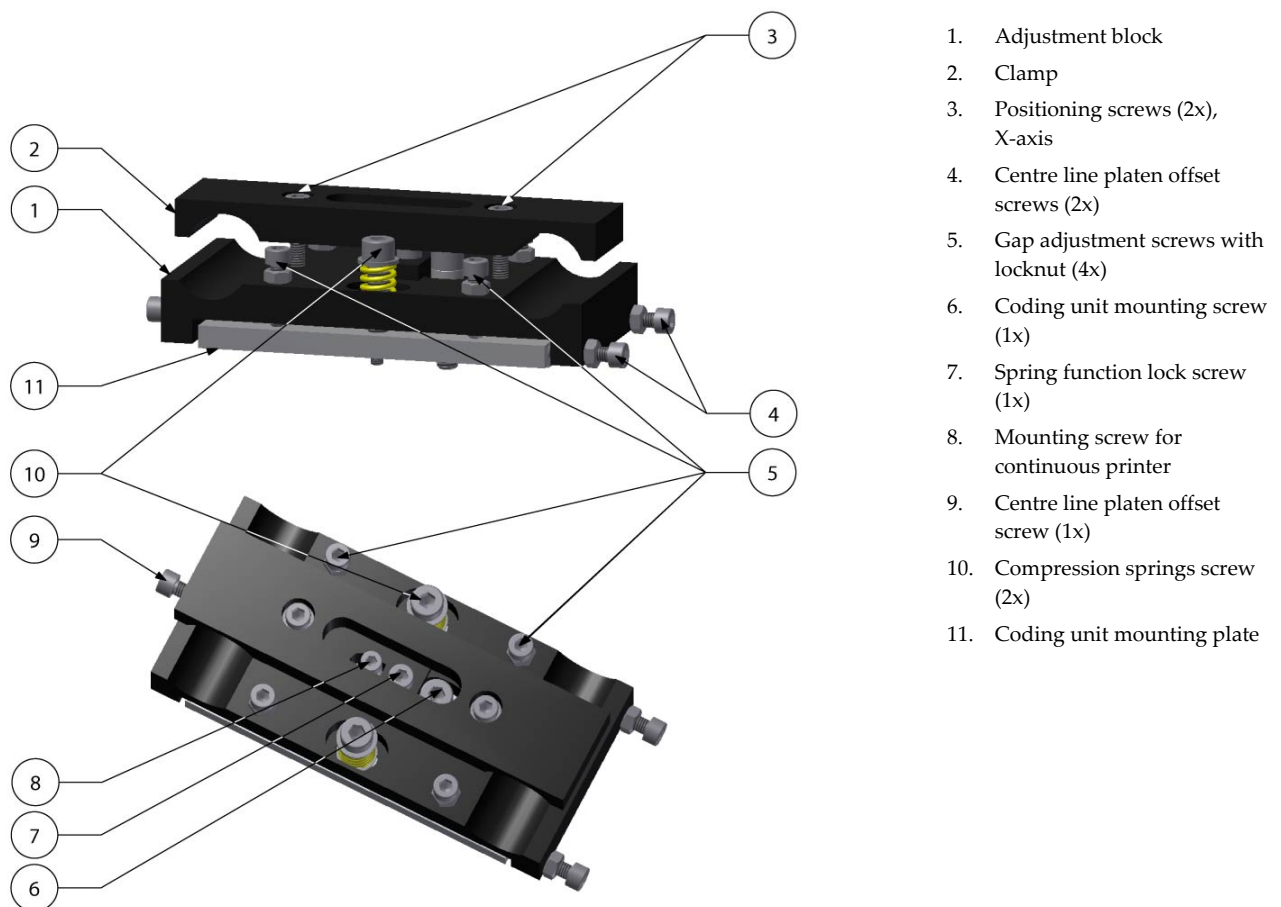

Fig. 7.4 Coding unit adjustment block.

1. Switch on the printer by operating the main switch on the control unit.
2. Disconnect the air supply to the coding unit.
3. Push the printhead down and check whether it horizontally aligned with the platen roller. If not, repeat the printhead alignment procedure, see paragraph 7.1.2.
4. Connect the air supply to the coding unit.
5. Set the system operating pressure at 0.1 MPa (1 bar) using the air regulator.
6. Check whether mounting plate (11) can move freely between the offset screws (4 + 9). If not loosen the offset screw (3).
7. Place and lock the magazine.
8. Load the 'Grid' test label. (refer to section 9.1.1).
9. Set the print density at 40%.
10. Move some substrate underneath the printhead and make some prints (when the preheat reached its set temperature) by pressing the test button.
11. Check the print process and the print result:
  - a. If the ribbon is moving sideways during the print process, the printhead is not in line with the platen roller. Use the lock screw (9) and the adjustment screws (4) to position the printhead in line. Make sure the printhead position is kept on the centre of the platen roller.
  - b. If the ribbon snaps during the print process, the printhead is probably positioned before the centre of the platen roller. Use the lock screw (9) and the adjustment screws (4) to position the printhead on the centre of the platen roller. Make sure the printhead position is kept in line with the platen roller.
  - c. If the print is vague, the printhead is probably not on centre of the platen roller. Use the lock screw (9) and the adjustment screws (4) to position the printhead on the centre of the platen roller. Make sure the printhead position is kept in line with the platen roller.
12. Repeat steps 8 and 9 till a good print result has been reached.
13. Secure the lock nuts (5), the compression spring screws (10) and the lock nuts of the platen offset screws (4).
14. Move some substrate underneath the printhead and make some prints (when the preheat reached its set temperature) by pressing the test button.
15. Set the density to a proper setting (e.g. 60%)
16. Check whether the print result is still ok. Repeat the procedure above if required.



**Note:**

Printing the Grid test label with a low density setting (e.g. 40%) makes it easier to see if the printhead is properly aligned to the platen roller.

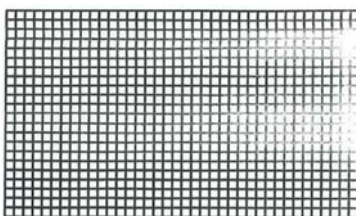

Fig. 7.5 Grid test label printed with incorrect alignment of printhead and platen roller (density 40%) (tightening of the adjustment screw at the top right corner will result in a good print)



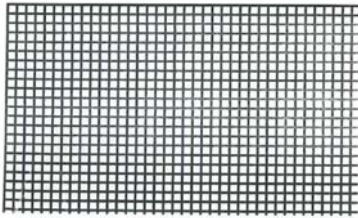

Fig. 7.6 Grid test label printed with correct alignment of printhead and platen roller (density 40%)

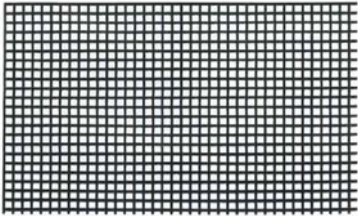

Fig. 7.7 Grid test label printed with correct alignment of printhead and platen roller (density 60%)

## 7.4 User settings

Fill out this table with the values found by setting the printer parameters. Use the table, as a reference, to set the printer parameters when the memory is reset to the default values. Alternatively create a Report file, see section 9.2.6 and store it in a place where it can be found if needed e.g. the main label folder on the label design PC.

Keep the values nearby, when calling the helpdesk of your local distributor.

Printer firmware version:					
QiC control version:					
FPGA version:					
PIC version:					
PX2 OS version:					
Boot version:					
WinCE version:					
WinOS version:					
Parameter	Default value	User	Parameter	Default value	User setting
Print delay	5 [mm]		Foil length	450 [m]	
Density	60%		Warning length	25 [m]	
Print quantity	0		PH resistance	1250 [Ohm]	
Debounce	8 [ms]		Pre-Heater	no	
Print queue	0		Temperature	30 [°C]	
Print input	High		Push Home	0 [ms]	
Busy output	High		IP address	10.0.1.2xx	
Alarm output	High		Subnet	255.255.255.0	
Low Foil output	High		Gateway	0.0.0.0	
Print missed	Error		Screen rotation	90°	
Encoder time-out	Error		Start paused	yes	
X-offset	0 [mm]		System language	English	
Y-offset	0 [mm]		Date language	English	
Character spacing	0				
Orientation	normal				

Fig. 7.8 Printer parameters, default and user values

## COMMISSION

Fill out this table and keep nearby, when calling the helpdesk of your local distributor.

Manufacturer host machine, type	
QiC printer model	
Control box, serial number	A
Coding unit, serial number	B
Cassette, serial number	C
Production plant	
Production line	
Type of substrate (product) / Ribbon type	/
Production / print rate	Cycles / min
Ambient temperature (min, max)	°C (min) / °C (max)

Fig. 7.9 Printer environment information

# 8 OPERATION

This part describes the functions and procedures for operating the printer.

## 8.1 Powering up

1. Check whether the printer is damaged by visual inspection.
2. Check whether all of the relevant cables are connected.
3. Switch on the control unit.



**Note:**

When the system parameter *Start paused* is set to *No*, the printer will start printing as soon as the print engine is powered up and a print request is received. The print engine is active before the Main menu is shown. Refer to subsection 8.6.1.



**Note:**

During the boot process the *Screen calibration* screen will be shown. Do not touch this screen unless the screen calibration of the controller is incorrect. Refer to section 9.3.

4. Wait until the Main menu is shown.



Fig. 8.1 Main menu

5. Check whether the printer is ready to print, the LED indicators on the coding unit should show a blue light (power on) and a green light (label selected).
6. Access the desired menu function by pressing the appropriate function button.

## 8.2 Operational

### 8.2.1 Start printing

1. Check whether the desired label is selected. If not, touch the *Select label* button. Refer to subsection 8.4.1 for more information about how to select a label.

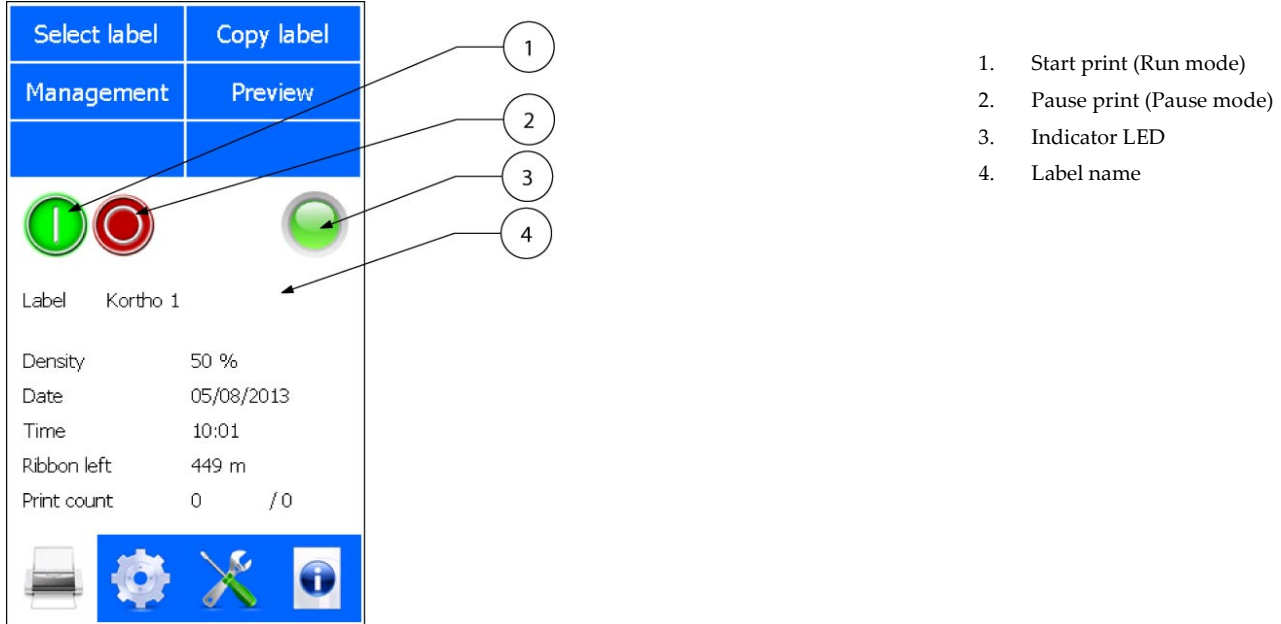

Fig. 8.2 Main menu

2. Check whether the *Start print* button is activated, if not touch the *Start print* button to set the printer in the run mode.
3. Make sure the substrate is moving, apply a print request signal to the printer and the printer will make a print.
4. To pause the printer, touch the *Pause print* button.



**Note:**

If a print request is received during the pause mode, a popup will appear on screen, showing warning 44: the printer is paused.

## 8.3 Operator data input

Labels are designed on the PC based design tool QiC Draw, NiceLabel or an alternative Windows based program using the NiceLabel driver, see subsection 2.5. These labels can contain operator input fields, which should be filled out by the operator at the start of the print session.

Refer to subsection 3.4.4 for the available keyboard options.

### 8.3.1 Text item input menu

The operator input text can be entered using the keyboard. The user prompt text can be set during label design.

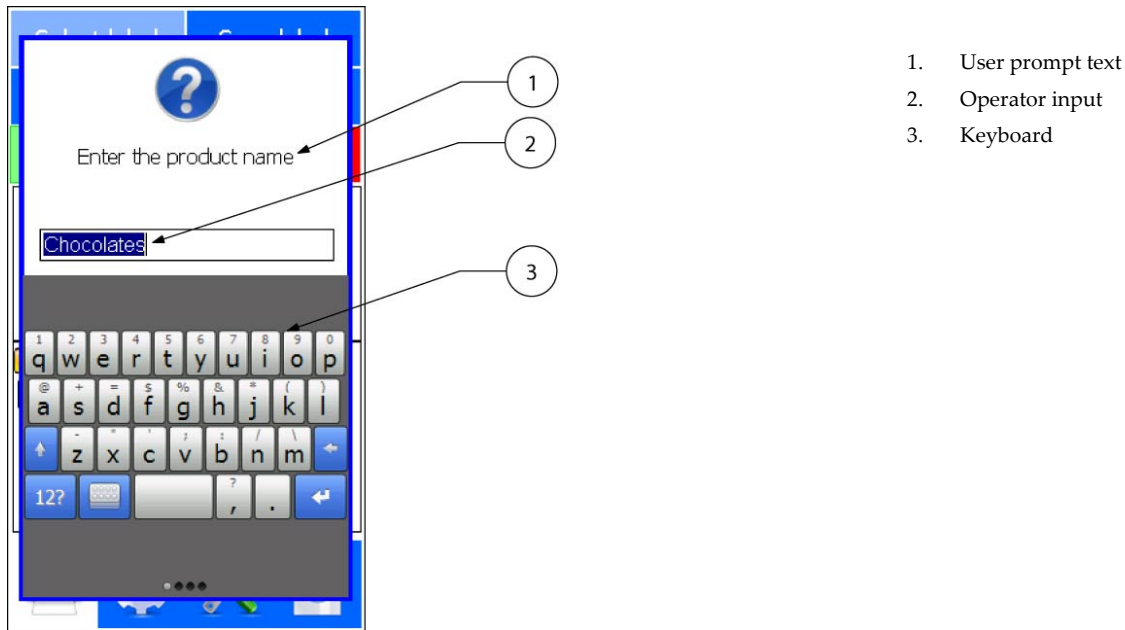

Fig. 8.3 Text item input menu

The use of a user prompt is especially useful if a label has more than one text item that requires changing the contents.

The Operator input shows the text which was used during the previous print run with the selected label or the initial string defined in the label design program. In addition, the length of this string is defined in the label design program. The string, which can contain any mix of characters, can be edited by the operator. One can mark the character(s) which need to be edited and touch the required character(s) that need(s) to replace the old character(s). Alternatively a cursor is indicating the location at which a new character will be inserted.

Use the keys of the keyboard to enter alphanumeric characters. Refer to subsection 3.4.4 for selecting the alternative keyboards.

To edit a string:

1. Touch the Operator input text to select the character(s) that need(s) to be changed.
2. Enter the desired new character(s). The desired character(s) is(are) inserted at the cursor position.
3. Repeat the previous instructions until all the characters have been edited or entered.
4. To delete characters, select the characters that need to be deleted and touch *Backspace*. Alternatively, place the cursor behind the characters that need to be deleted and touch *Backspace* to remove character by character.
5. Touch *Enter* to confirm the Operator input.

## 8.3.2 Date advance input menu

The offset (advance) of a date code can also be entered using an operator input. The User prompt text can be set during the label design.

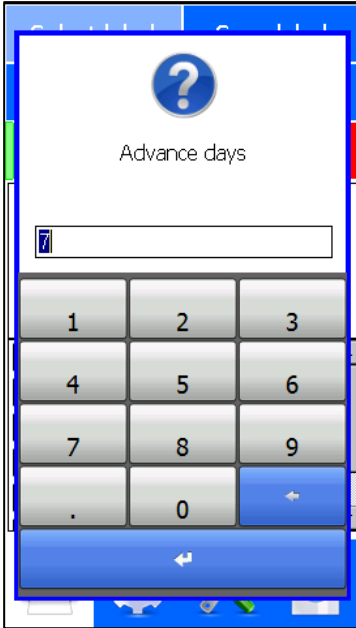

Fig. 8.4 Date advance input menu

The date field, which can be edited by the operator, accepts only valid inputs. The digit that can be edited is marked with a cursor beneath it.

To edit the value of the Date advance item:

To enter a complete new value:

1. Enter the desired new offset.
2. Touch *Enter* to confirm the Operator input.

To change only a few numbers:

1. Touch the Input text to select the digit(s) that need(s) to be changed.
2. Enter the desired new digit(s). The desired digit(s) is (are) inserted at the cursor position.
3. Repeat the previous instructions until all the digit(s) have been edited or entered.
4. To delete digits, select the digits that need to be deleted and touch *Backspace*. Alternatively, place the cursor behind the digits that need to be deleted and touch *Backspace* to remove the text digit by digit.
5. Touch *Enter* to confirm the Operator input.

### 8.3.3 Number start value input menu

The number displayed on screen is the last value entered on the system by the operator. The very first time the label is selected, it will show the start value entered in the label design software.

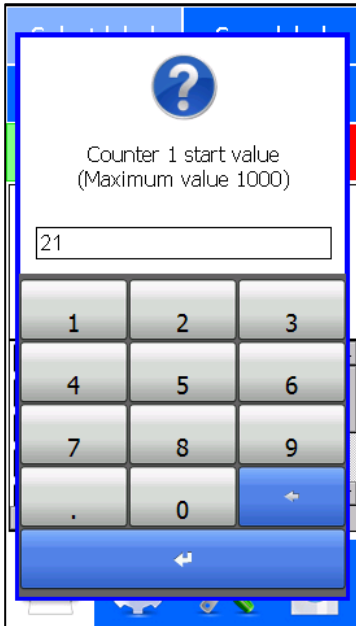

Fig. 8.5 Number start value input menu

The number field shows the last entered value used at a previous print run with this label or the initial value defined by the label design program.

The number field, which can be edited by the operator, only accepts valid numbers as defined by the label design program.

To enter a complete new value:

1. Enter the desired new digit(s).
2. Touch *Enter* to confirm the Operator input.

To change only a few characters:

1. Touch the Input text to select the digit(s) that needs to be changed.
2. Enter the desired new digit(s). The desired digit(s) is (are) inserted at the cursor position.
3. Repeat the previous instructions until all the digits have been edited or entered.
4. To delete (a) digit(s), select the digit(s) that need to be deleted and touch *Backspace*. Alternatively, place the cursor behind the digit(s) that need to be deleted and touch *Backspace* to remove the text digit by digit.
5. Touch *Enter* to confirm the Operator input.

## 8.4 Label management

### 8.4.1 Selecting a label for printing

To select a label from the label memory:

1. Touch the *Select label* button. The contents of the label memory is displayed and a further two buttons will appear, *Select* and *Cancel*.

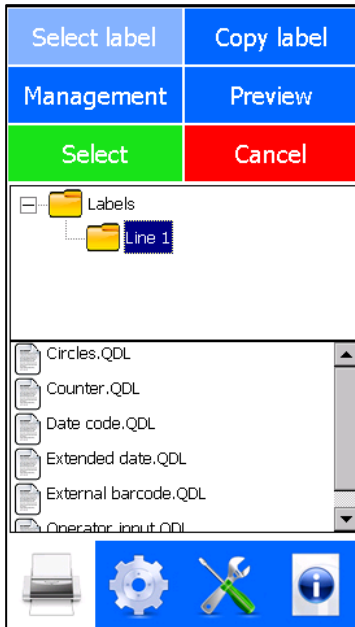

Fig. 8.6 Select label menu

2. Touch a folder and alternatively its sub-folder in the upper window to make the label files appear in the lower window.
3. Touch the label that needs to be printed.
4. Touch the *Select* button.

The green LED will light up on the coding unit and the printhead will move backwards and forwards to check the encoders.

5. The operator input screen will appear if the label selected requires the input of data, see section 8.3.
6. Enter the required data and touch *Enter*, the system will return to the Main screen.
7. Touching the *Preview* button will show a preview of the label that will be printed, see also section 8.4.5.

### 8.4.2 Transferring labels to the controller

To transfer labels to the printer first insert a USB thumbdrive containing one or more labels and/or label directories and wait for around 3 seconds (for USB thumbdrive with a LED: wait until the LED flashes).

1. Touch the *Copy label* button. The contents of the label memory is displayed and a further two buttons will appear, *Copy* and *Cancel*.



## OPERATION

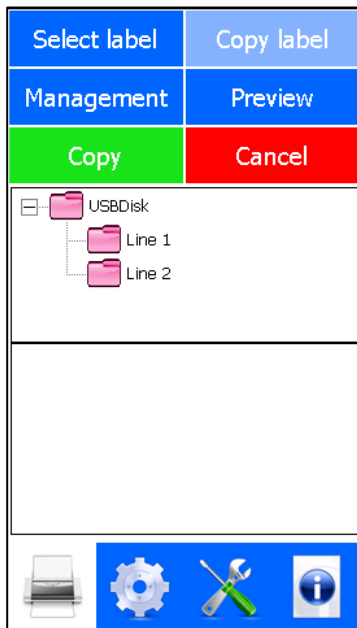

Fig. 8.7 Copy label menu, USB thumbdrive



**Note:**

The directories that are stored on the USB thumbdrive are shown in pink, while the directories that are stored in the label memory are shown in yellow.

2. Touch a folder or one of its sub-folders in the upper window to make the label files appear in the lower window.
3. Touch the sub-folder or file in the lower window that needs to be copied.
4. Touch the green *Copy* button.
5. The screen will switch to the explorer screen of the label memory.



Fig. 8.8 Copy label menu, label memory

6. Touch the label folder to which the labels need to be copied to (The printer initially has one folder called Labels).
7. Select the *Paste* button. The selected USB thumbdrive labels will now be copied to the controller.

## OPERATION

8. If a label name already exists in the label memory the Overwrite label message will appear on screen.

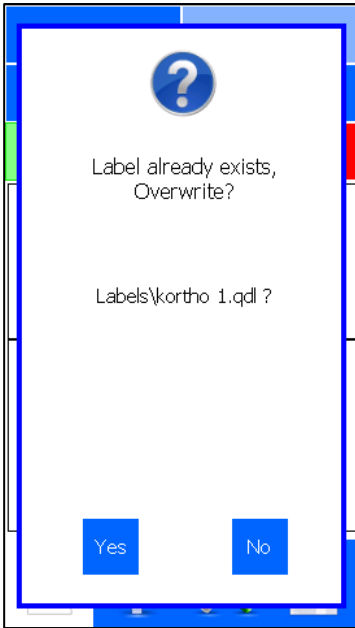

Fig. 8.9 Overwriting label message

9. Touch *Yes* and the label will be overwritten.
10. Touch *No* and the Paste operation will be cancelled.
11. If copying of a label fails, the Copy label failed message will appear on screen. Touch *Ok* to return to the Main menu.

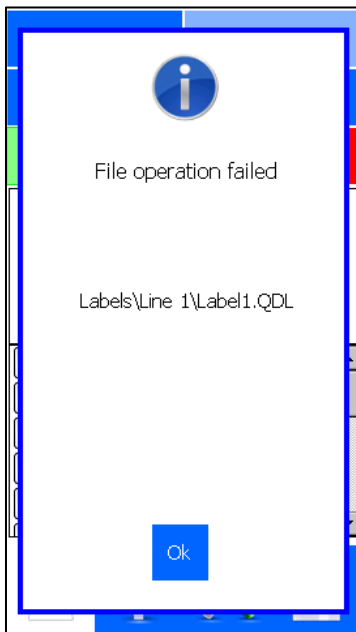

Fig. 8.10 Copy label(s) failed message

12. When there is not enough memory available for the labels to be copied, an Insufficient memory message appears on screen. Copying 'new' labels is only possible when some 'old' labels are deleted or the memory is cleared. Refer to the next subsections 8.4.4.



Fig. 8.11 Insufficient memory message

13. The copy procedure is now finished.

### 8.4.3 Moving a label

There is a Move function available to make it possible to rearrange the label files and directories.

1. Select *Management* in the Main menu.

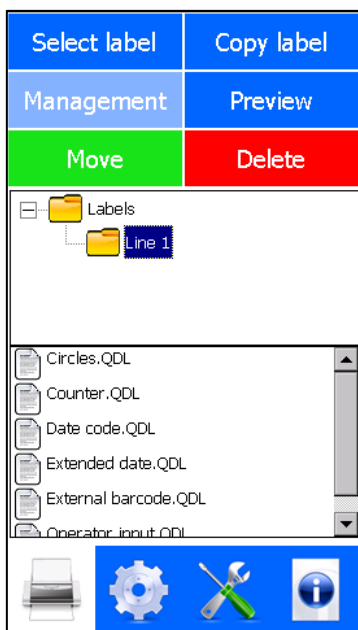

Fig. 8.12 Move label menu

2. Touch the label file or folder which needs to be moved in the lower window.
3. Touch *Move*, the following screen will appear.

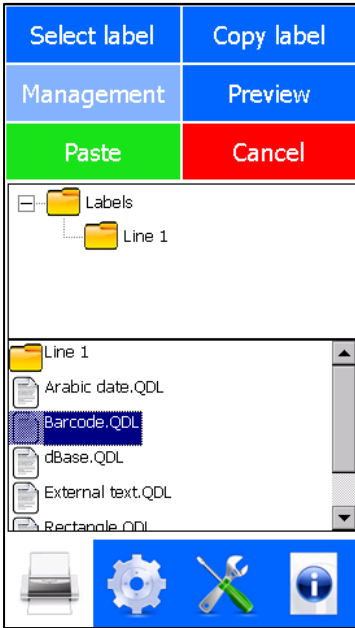

Fig. 8.13 Paste label menu

4. Touch the folder to which the label or folder label file needs to be moved to (upper window).
5. Touch the *Paste* button.
6. The Move procedure is now finished.

### 8.4.4 Deleting a label

There is a Delete function available to make it possible to remove label files and/or folders.

1. Select *Management* in the Main menu.

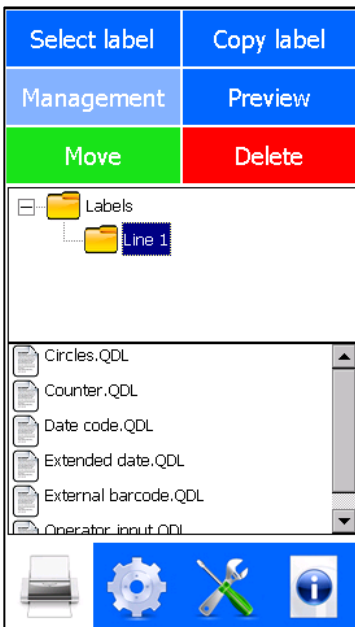

Fig. 8.14 Delete label menu

2. Touch the label file or folder that needs to be deleted in the lower window.
3. Touch *Delete*, the following screen will appear.

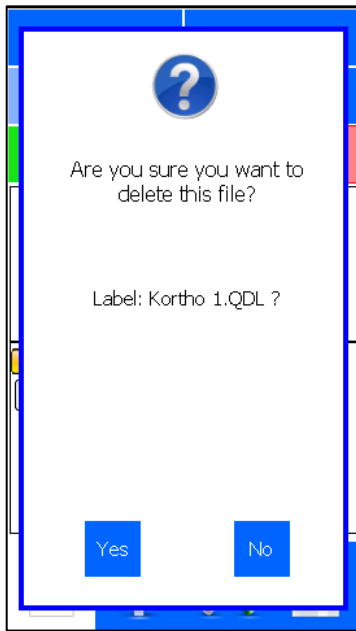

Fig. 8.15 Delete label message

4. If the label or folder really needs to be deleted, confirm this by pressing *Yes*.
5. If the label or folder does not need to be deleted, touch *No* to cancel the operation.

### 8.4.5 Showing a preview

There is a Preview function available that will show the currently printed label on screen.

1. Select *Preview* in the Main menu, The first preview screen will show a 1:8 picture.

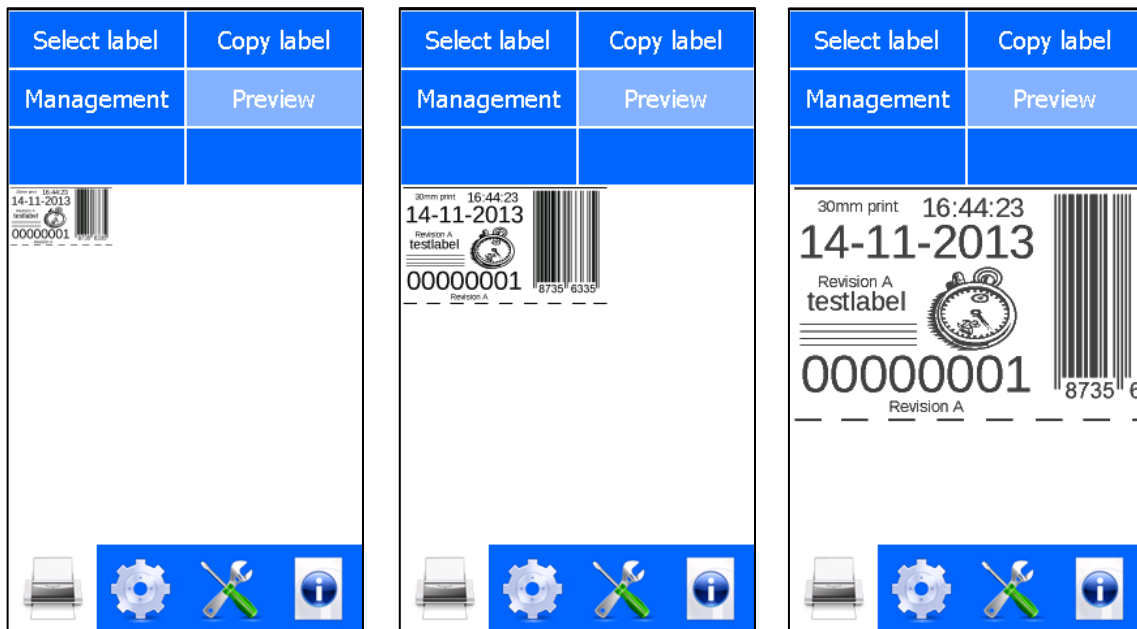

Fig. 8.16 Preview screen

2. Touch *Preview* again to show a 1:4 picture.
3. Touch *Preview* again to show a 1:2 picture.

When the label is larger than the screen, one can use the touchscreen to drag the preview around.

## 8.5 Magazine handling

**CAUTION:**

The magazine handling is described for a cR-model. If one is using a cL model the direction in which the magazine handle is rotated should be opposite to the description in this chapter.

### 8.5.1 Removing the magazine

1. Push the handle inwards and move the handle in a clockwise direction until the handle faces 9 o'clock.

**Note:**

The status LED will turn orange.

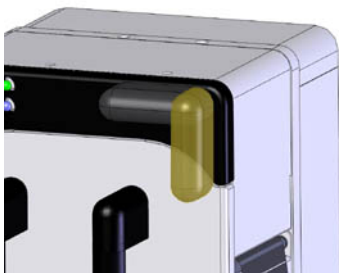

Fig. 8.17 Unlock magazine

2. Use both hands and pull on the magazine handles with equal force to remove the magazine.

### 8.5.2 Placing the magazine

1. Align the magazine guide posts with the guide tubes mounted on the printer and slide the magazine to its home position until it is fully engaged with the printer body.



Fig. 8.18 Lock magazine

2. Push the magazine into the printer body (against the spring pressure of the drive mechanism) and lock the magazine by pushing the magazine handle in and turning it in an anti-clockwise direction until positioned at 6 o'clock.
3. Push the front button to reset the printer.
4. Check whether all LEDs are system ready (Status LED Green, Power LED blue).
5. If not paused, set the system in pause mode.
6. Make a test print by moving the substrate and pushing the button again.
7. The printer is now ready for printing.

### 8.5.3 (Re)placing ribbon

1. Pause the printer process.
2. Remove the magazine, see section 8.5.1.
3. Remove the used ribbon and empty core.
4. Re-use the empty core on the take-up spool.
5. Clean the ribbon sensor roller with a lint free wipe soaked in isopropanol.
6. Place new ribbon roll onto the feed spool and direct the ribbon along the path shown in the diagram, see Fig. 8.19.
7. Tape the ribbon on the empty take-up core (a new roll of ribbon has an adhesive part at the beginning of the ribbon).

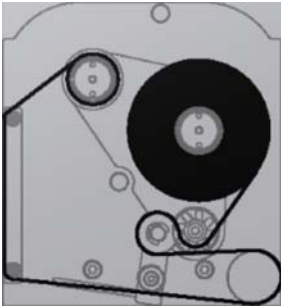

Fig. 8.19 Ribbon path

8. Tension the ribbon by turning the ribbon drive roller clockwise a few turns to wind up some ribbon.
9. Place the magazine back and press the front button to get the system operational again, see section 8.5.2.
10. Press and hold the front button for about 4 seconds to reset the ribbon left value to the length of a full roll (the reset procedure is completed when the LED flashes green/orange).
11. The printer is now ready for printing.

## 8.6 Adjusting printer settings

1. Touch the *Settings* icon located at the bottom of the screen. The following status screen is shown.

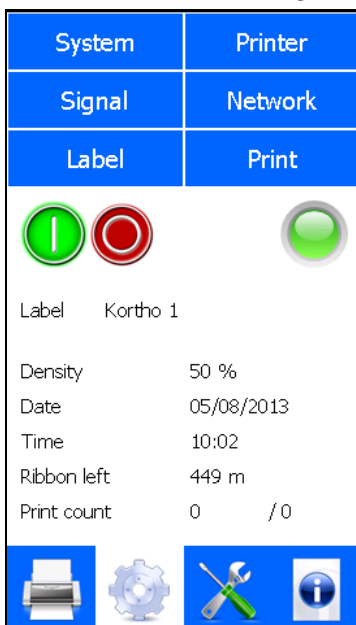

Fig. 8.20 Settings menu

## 8.6.1 System settings

1. To change the system settings touch the *System* button at the top of the screen.

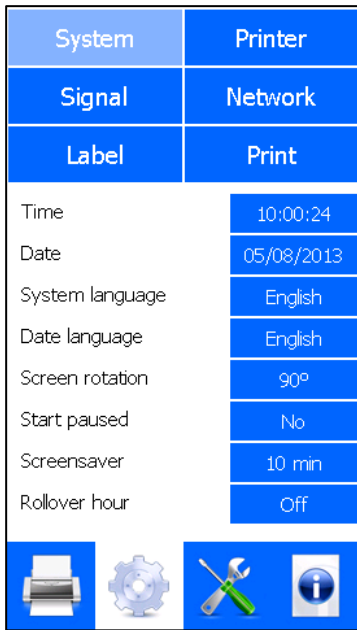

Fig. 8.21 System settings menu

### Time and/or Date

1. Touch the blue button that shows *Time* or *Date*.

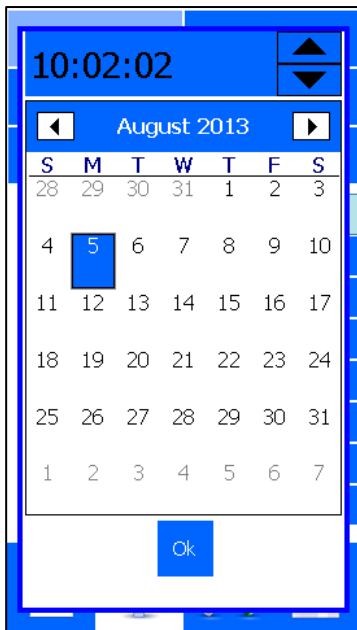

Fig. 8.22 Date and Time menu

2. Touch the item that needs changing, e.g. hours, minutes or seconds.
3. Touch the arrow up or arrow down to adjust the time.
4. Touch the arrow left or arrow right to change the month and year.
5. Touch the day of the month to change the selected date.
6. Touch *Ok* to confirm and store the new settings.



## System language

1. Touch the blue button that shows System language.

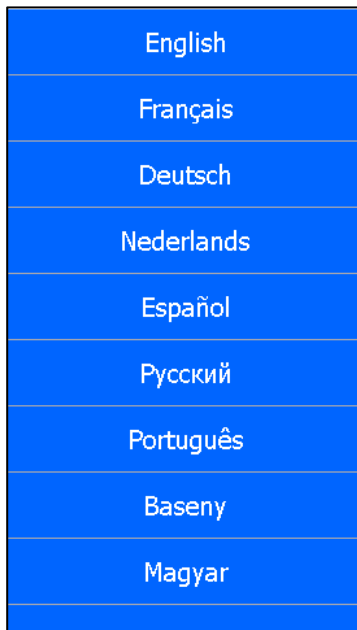

Fig. 8.23 System language selection menu

2. Touch the language button to select another language.



**Note:**

When there are more languages than fit on screen, one can touch the screen and drag up and downwards to select the required language.

3. The system will ask if it should reboot.

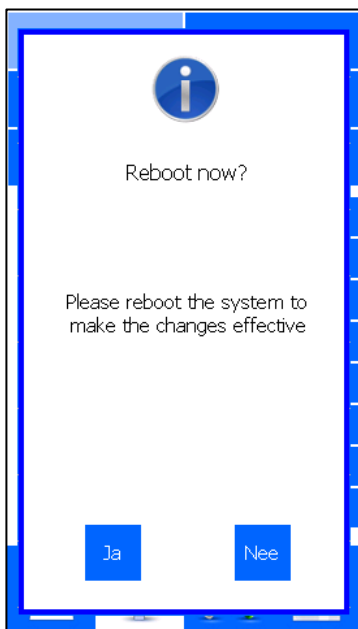

Fig. 8.24 Reboot message screen

4. Touch *Yes* to set the new language immediately. The graphical interface will reboot, but this does not affect the printing process.

5. Touch *No* if:
  - a. The wrong language has been selected. Select the correct language immediately after aborting the system reboot procedure.
  - b. The new language must not be applied immediately, but on next boot up.

## Date language

The language set as Date language is used to print the Months and Day of the week (e.g. when set to English: Monday, Mon, January, Jan. When set to Dutch: Maandag, Maa, Januari, Jan).

1. Touch the *Date language* button.

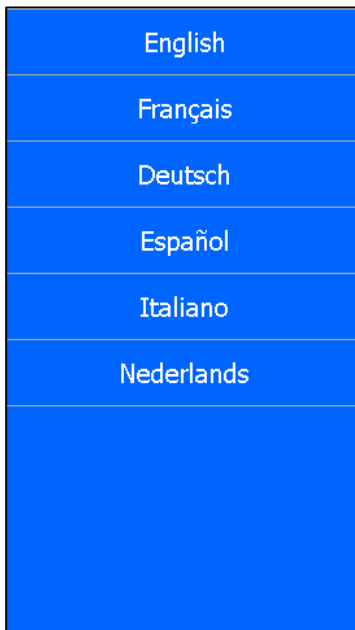

Fig. 8.25 Date Language selection menu

2. Touch the language button to select another language.

## Screen orientation

1. Touch the blue button that shows *Screen orientation*.

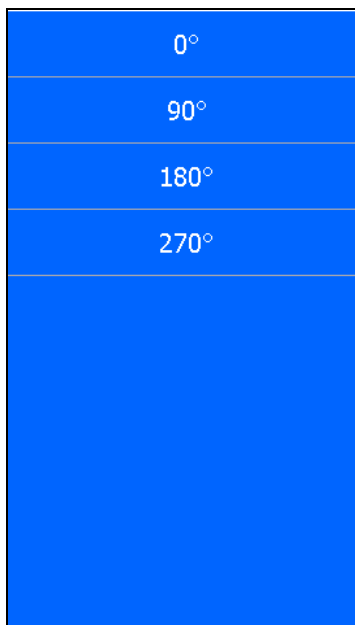

Fig. 8.26 Screen orientation selection menu

2. Touch the desired screen orientation.
3. The system will ask if it should reboot.

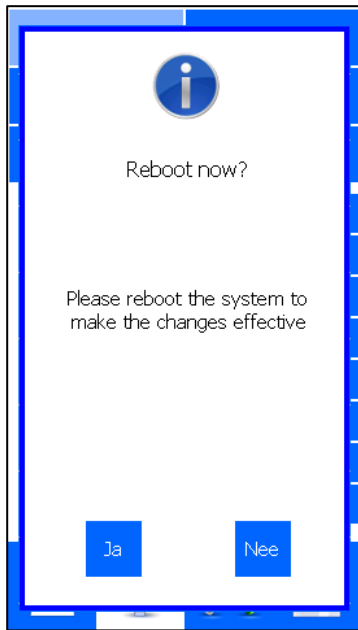

Fig. 8.27 Reboot message screen

4. Touch *Yes* to set the new screen orientation.
5. Touch *No* if:
  - a. The wrong screen orientation has been selected. Select the correct screen orientation immediately after aborting the system reboot procedure.
  - b. The new screen orientation does not need to be applied immediately, but on next boot up.

### Start paused

1. Touch the blue button that shows *Start paused* to change the setting from *No* to *Yes* or from *Yes* to *No*. When *Yes* is selected the printer will boot in pause mode. While in pause mode the printer will ignore print request signals applied. In order to start the print process the operator should touch the start print button. When *No* is selected the printer will boot in run mode. The printer will immediately make a print when the print processor is ready to start the print process and a print request signal is applied.



**Note:**

The print engine is ready to print before user interface has completely booted. As soon as the print engine is ready the printer will make a print as soon as a print request signal is applied.

## Screensaver

1. Touch the blue button that shows *Screensaver*.

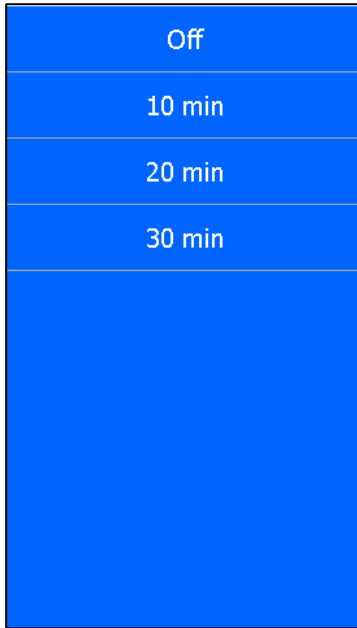

Fig. 8.28 Screensaver selection menu

2. Select the period of time after which the screen save mode must become active, when the screen is not touched.

The printer will continue to function normal while the screen save mode is active. After touching the screen it will be powered on again.

## Rollover hour

1. Touch the blue button that shows *Rollover hour* to change the hour at which the printed date needs to turn over to the next day.

The default setting is Off, which means the date will turn over to the next day at 24:00. If e.g. the date needs to change at 03:00 the Rollover hour needs to be set to 3.

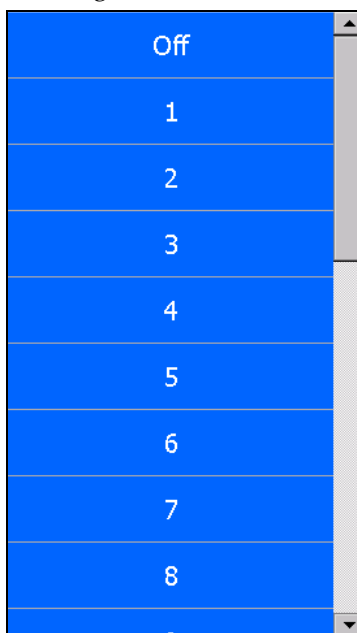

Fig. 8.29 Rollover hour selection menu

## 8.6.2 Printer settings

To change the printer settings touch the *Printer* button.

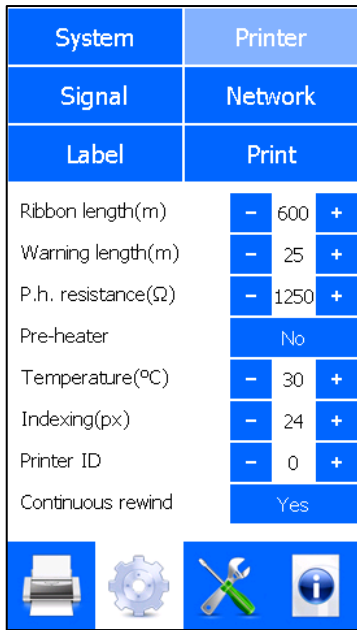

Fig. 8.30 System settings menu

### Changing the printer settings

To change numeric settings:

1. Touch the + / - buttons, or
2. Touch the value shown to enter it from the numerical keyboard.

To change selectable settings:

1. Touch the button and the setting will change (toggle function), or
2. When touching the button a list of choices will appear from which the required setting can be selected.

### Ribbon length

It is important to set this value to correctly show the length of unused ribbon that is left on the printer magazine so that the system can warn the operator when the ribbon is almost used up. See section 9.1.6.

### Warning length

This value (metres ribbon left) determines when the system will create a "low ribbon" warning indication. A message will be shown on screen and the orange LED on the coding unit will flash to indicate this.

### Print head resistance

It is important to set this value to reflect the resistance of the currently fitted print head. The resistance is noted on the serial label of the printhead. The value is always between 1000-1500Ohm.



**CAUTION:**

If the print head resistance is set incorrectly the print had can be damaged resulting in a poor print quality or no print at all.

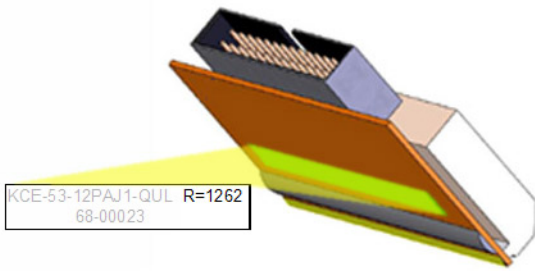

Fig. 8.31 Print head resistance

## Pre-heater

This setting should be used to switch the pre-heat function on or off. The preheat function is used to regulate the temperature of the printhead to ensure optimal print quality. It is recommended that the Pre-heater setting be set to *Yes* when the temperature inside the building, in which the printer is used, is below 20°C or when the substrate is hard to print on. When *Yes* is selected a green LED will light on the control unit when power is supplied to the heating element. Set the temperature using the *Temperature* setting.

## Temperature

See Pre-heater above. Depending on the print quality the value must be adjusted to the optimal value. The range is 25°C to 45°C. Refer to subsection 7.3.

## Indexing

This setting offers the option to transport more or less ribbon (-12 pixels = -1 mm) during the rewind process. This will be visible by an increasing or decreasing gap (distance between 2 prints on the ribbon used).

## Printer ID

This is a number from 0-255 that can be used to identify the printer. The printer ID can be used in the label design and can in this way be printed on the substrate.

## Continuous rewind

This options can be set to *No* or *Yes* and offers the option to block the rewinding of the ribbon after a print has been made. When set to *No* the ribbon will not be rewound, due to which the amount of prints per minute can be increased. Disadvantage is that the printer will use more ribbon, i.e. the ribbon gap will be bigger. When set to *Yes* the ribbon will be rewound after a print has been made. When this function is active, the ribbon waste is minimal.

### 8.6.3 Signal settings

To change the signal settings touch the *Signal* button.



**CAUTION:**

These settings will be set during installation; only a trained engineer should change them.

System	Printer
Signal	Network
Label	Print
Print input	High
Busy output	High
Alarm output	High
Multi function output	High
Print missed	Error
Encoder timeout	Error
Multi function choice	Low Ribbon
Under speed	Error

System	Printer
Signal	Network
Label	Print
Print input	High
Busy output	High
Alarm output	High
Multi function output	High
Print missed	Error
Encoder timeout	Error
Multi function choice	Low Ribbon
Under speed	Error
Over speed	Error

Fig. 8.32 Signal settings menu

## Changing the signal settings

To change numeric settings:

1. Touch the + / - buttons, or
2. Touch the value shown to enter it from the numerical keyboard.

To change selectable settings:

1. Touch the button and the setting will change (toggle function), or
2. When touching the button a list of choices will appear from which the required setting can be selected.

### Print input

Select the rising edge or falling edge of the product detection sensor. This setting depends on which type of sensor is used and how it is set.

Usually, the sensor is set in a way that the print will be made on the rising edge. Default setting is High (rising edge).

### Busy output

This output signal tells the host machine that the printer is busy printing and that the substrate should not move. This signal can be leading (High) or falling (Low) edge synchronised.

This signal is active from the moment the thermal printhead is going down until it is going up again. So, the period that the thermal printhead is in contact with the substrate.

### Alarm output

The output signal tells the host machine that an error has occurred which requires user attention. This signal can be set to be active high or active low.

## Multi function output

Set this to correspond to the required output level when the output is active. This signal can be set to be active high or active low. The function of the Multi function output is set by the Multi function choice.

## Print missed

This signal is activated when the printer receives a print request signal while it the previous printcycle is still in progress.

This parameter can be set to *Error* or *Warning*. When set to *Error* a missed print will abort the printing process and the general alarm will be set. When set to *Warning*, the print process will continue when a missed print is detected, a warning will be displayed on screen and depending on the *Multi function choice* setting, see below, the Warning output will be activated for 50ms (pulse).

## Encoder timeout

This parameter can be set to *Error* or *Warning*. When set to *Error*, an encoder timeout will abort the printing process and the general alarm will be set. When set to *Warning*, printing will continue and a warning will be displayed on screen and depending on the *Multi function choice* setting, see below, the Warning output will be activated for 50ms (pulse).

This signal is activated when the external encoder is not generating a puls within a certain amount of time. The signal is only activated when the printer is in the middle of a printsignal. At the moment the signal is activated the print cycle will be aborted and the system will wait for the next print request signal.

## Multi function choice

This parameter can be set to *Low Ribbon* if this output is used to indicate low ribbon on the printer. Alternatively it can be set to *Warning* if the system should use the output to indicate that a warning has occurred. At that time the output will generate a 50ms (pulse).

When set to *Warning* the multi function output can e.g. be used to trigger an external device that removes the non-coded product from the production line.

## Underspeed

This parameter can be set to *Error* or *Warning*. When set to *Error* the printer will abort the printing process and set the general alarm if the print speed becomes lower then 2,7 m/min. When set to *Warning*, the print process will continue and a warning will be displayed on screen as soon as the measured substrate speed becomes lower then 2,7 m/min.

If the underspeed situation is not resolved before the next print request signal(s), the printer will simple ignore this(these) print request signal(s). The printer will start to print again on the first print request signal that is received after the underspeed situation is resolved.

## Overspeed

This parameter can be set to *Error* or *Warning*. When set to *Error* the printer will abort the printing process and set the general alarm if the measured substrate speed becomes higher then 35 m/min. When set to *Warning*, the print process will continue and a warning will be displayed on screen as soon as the measured substrate speed becomes higher then 30 m/min.



If the overspeed situation is not resolved before the next print request signal(s), the printer will simply ignore this(these) print request signal(s). The printer will start to print again on the first print request signal that is received after the overspeed situation is resolved.

## 8.6.4 Network settings

These settings make sure the system can be reached over the internal network and that communication between e.g. PC (label design) and printer can take place.

To make sure the settings will match the network settings, always talk to the network administrator for help integrating the printer into the company network.

Touch the *Network* button to open network settings menu.

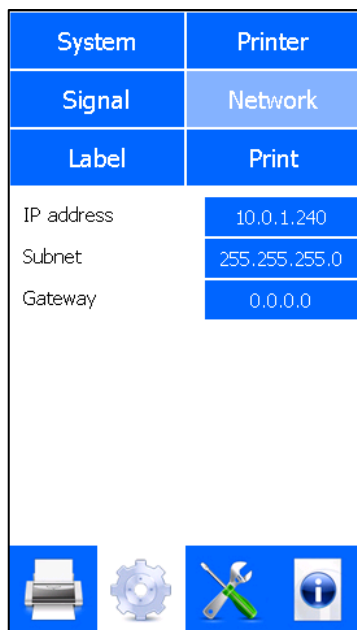

Fig. 8.33 Network settings menu

### IP Address, Subnet and Gateway

1. Touch the corresponding blue button and the following screen will appear.



Fig. 8.34 Network settings, IP address

2. Enter the desired value (do not forget to enter the decimal points).
3. Confirm with *Enter*.
4. Reboot the system to activate the new network settings.

When one doesn't reboot the system immediately, the old settings will remain active until the next boot-up.

### 8.6.5 Label settings

To change the label settings of the printer touch the *Label* button.

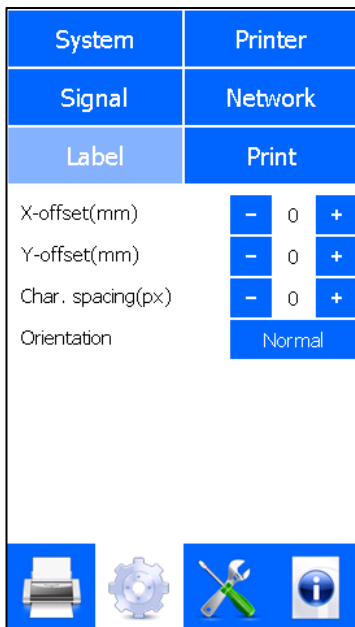

Fig. 8.35 Label settings menu

### Changing the label settings

To change numeric settings:

1. Touch the + / - buttons, or
2. Touch the value shown to enter it from the numerical keyboard.

To change selectable settings:

1. Touch the button and the setting will change (toggle function), or
2. When touching the button a list with choices will appear from which the required setting can be selected.

### X-Offset and Y-Offset

The label can be moved along the X-axis and/or the Y-axis of the printer. X is along the print head and Y is in the print direction. Changing the settings will move the label printed on the product in the corresponding direction. The offsets are entered in mm.



#### CAUTION:

If the label is offset too much one could lose parts of the print. To prevent the most common issues, the system will perform a check on the Y-offset.

- When a new label is loaded: the system will check whether the new label will be completely printed with current Y-offset. If not the Y-offset will be reset to 0.
- When the Y-offset is changed: the system will check whether the current label will be completely printed with the new Y-offset. If not the system will show a warning telling the Y-offset value is too high.

### Character spacing

The distance between the characters in a text can be enlarged (inter character spacing). All text in a label is altered by this value. The units are 1/12 mm. Re-select the label to effectuate this change.

### Label orientation

The orientation of the label to be printed can be changed in the firmware of the printer.

1. Touch the *Orientation* button.



Fig. 8.36 Orientation setting selection

2. Select the required orientation.

*Mirror* flips the printed label along the width of the print head. *180°* rotates the label 180 degrees around the centre of the print head. *Mirror / 180°* combines the other two rotations.

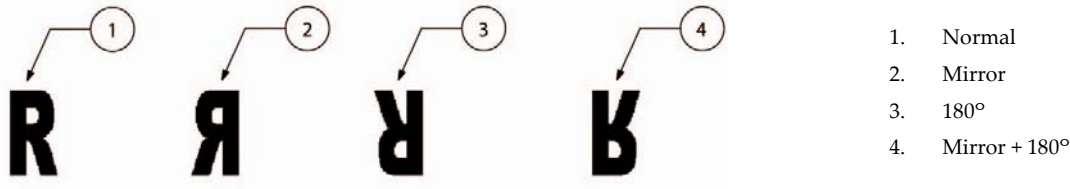

Fig. 8.37 Orientation setting

### 8.6.6 Print settings

To change the print settings of the printer touch the *Print* button.

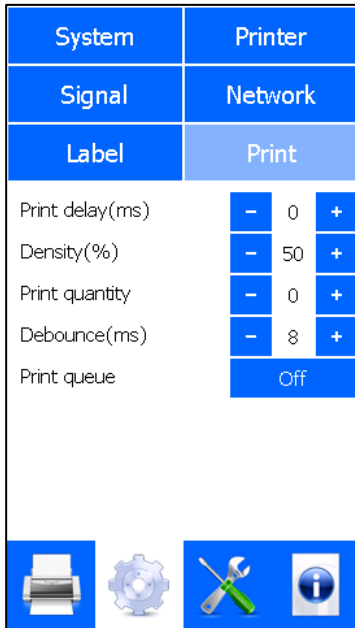

Fig. 8.38 Print settings menu

### Changing the print settings

To change numeric settings:

1. Touch the + / - buttons, or
2. Touch the value shown to enter it from the numerical keyboard.

To change selectable settings:

1. Touch the button and the setting will change (toggle function), or
2. When touching the button a list with choices will appear from which the required setting can be selected.

### Print delay

This value sets the delay. Delay is the distance, set in millimeters, that the substrate must move after receiving a print request before the actual print will be made.

The best moment to make a print is when the substrate speed is moving at a stable speed. As there are always speed variations within a machinecycle, it is important to make the print at the right moment within this machinecycle. To print delay can be used to place the print in the “plateau” of the machinecycle (period in which the speed is stable). Alternatively this option can be also be used to fine tune the position of the printed label on the substrate.

## Density

This value varies the amount of energy applied to the thermal printhead and therefore the amount of heat that is applied to the ribbon. It is required to set the density for each individual application (combination of e.g. substrate, ribbon, temperature, humidity) to get the best print quality possible.



**CAUTION:**

If not enough heat is applied to the ribbon, the pigment that makes up the printed label may not adhere correctly to the product. If too much heat is applied to the ribbon it may not adhere correctly or potentially the print head could be damaged.



**CAUTION:**

Always use the lowest density setting possible, this as the lifetime of the printhead will be influenced by the density setting.

## Print quantity

This value sets the number of labels to print. When the set value has been reached, the printer will stop the printing process and the General alarm output will be activated to indicate that the batch is complete. When set to zero the current label will print indefinitely.

## Debounce

The debounce time is the time a print request signal needs to be active to be regarded as a valid print request. A shorter signal is considered to be noise and will not result in a print. The unit are milliseconds.

## Print queue

Set this to *On* if a print request signal that's coming in during a print need to be queued. When set to *Off* a print request signal that's coming in during a print will set the Print missed error/warning.

Print queue means that a print request is put in the queue when the system is already in a print cycle. The print queue can store 1 print request.



**Note:**

When the print queue contains a print request, this print request will be executed directly after the current print has been made. When multiple print requests come in during a print cycle, only 1 will be stored in the print queue. The others are simply disregarded. This in turn implies that the Print missed error or warning is not active when the print queue is activated.



**CAUTION:**

If a print request is received during the current print cycle, the system will make a print right after the current print has been made. When the printer is placed in a intermittent packaging machine, this could result in making a print during the phase that the substrate speed is too low or too high. This will lead to a underspeed or overspeed error.



# 9 DIAGNOSTICS / TROUBLESHOOTING

For fault finding and problem solving a wide range of information screens and diagnostics functions is available in the system. Alternatively the Service module inside QiC Draw can be used.

## 9.1 Diagnostics

Touch the *Diagnostics* icon located at the bottom of the screen. The following status screen is shown.



Fig. 9.1 Diagnostics menu



**Beware:**

Many of the features in this section only work when the printer is paused. Pause the printer by pressing the *Pause* icon. When paused the red icon is brightly lit.

### 9.1.1 Test labels

For diagnostic reasons and for setting up the printer two test labels are factory programmed. These labels cannot be deleted from the system. To select a test label:

1. Touch the *Test Labels* button.

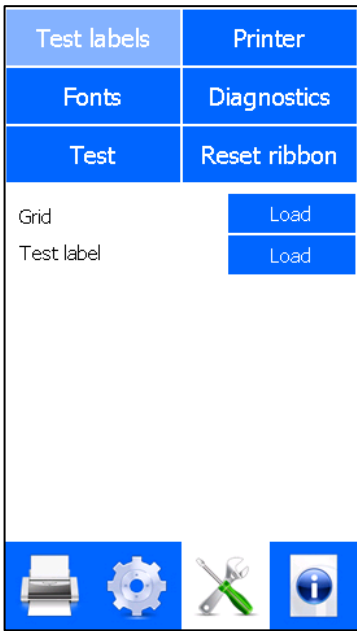

Fig. 9.2 Test label menu

2. Touch either of the *Load* buttons to load a test label. *Grid* loads a grid pattern test label and *Test label* loads a Kortho test label containing items like text, date, number and barcode.
3. The Test label loaded message will be displayed on screen.

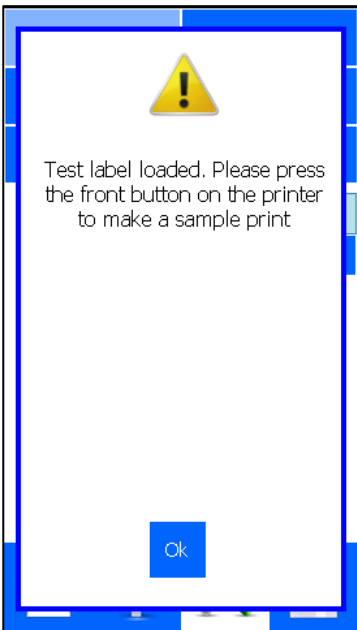

Fig. 9.3 Test label menu

4. Press the front button on the coding unit briefly to make a print. A sample print can also be made by using the Diagnostics Test function (see section 9.1.5).



**Beware:**

The Test label will remain selected until a new label is selected or the system is switched off and on again. Make sure another label is selected when starting up the production, otherwise the Test label will be printed during production.



## 9.1.2 Printer

Touch the *Printer* button to open the Printer menu.



Fig. 9.4 Printer main menu

### Printer

Touch the *Printer* button to show the diagnostics figures of the printer.

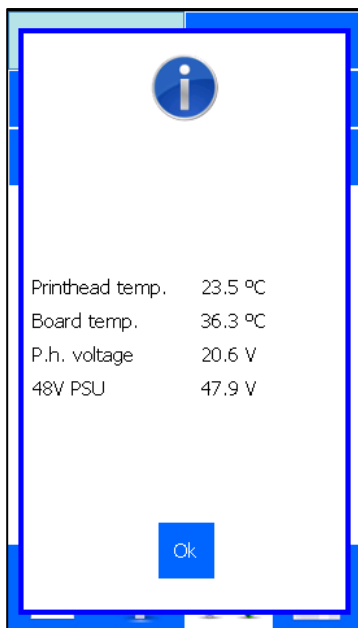

Fig. 9.5 Printer diagnostics screen

**Printhead temperature** - the ideal printing temperature is around 30°C.

**Board temperature** – the temperature of the main board that’s located in the control unit. It is measured by a sensor on the main board.

**Head voltage** – indicates the voltage applied to the printhead. This printhead drive voltage is generated by a formula that contains the density setting and printhead resistance.

**48V PSU** – indicates the voltage supplied by the 48V power supply.

## System

Touch the *System* button to show the information about the system.

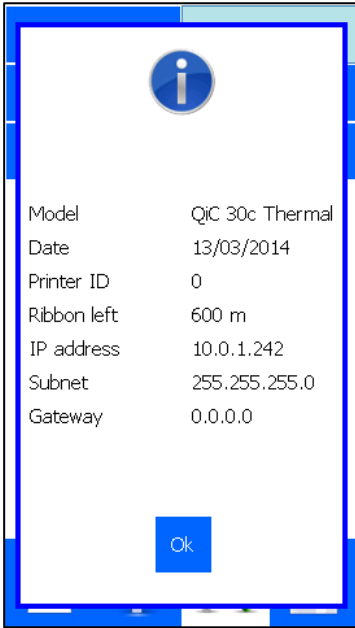

Fig. 9.6 System informatuion screen

**Model** – model of the printer connected to the control unit.

**Date** – system date of the control unit.

**Printer ID** – the printer ID as defined by the user.

**Ribbon left** - the length of remaining ribbon on the magazine, measured in metres.

**IP Address/Subnet/Gateway** – the set network addresses of the control unit.

## Software

Touch the *Software* button to show the installed firmware and software versions.

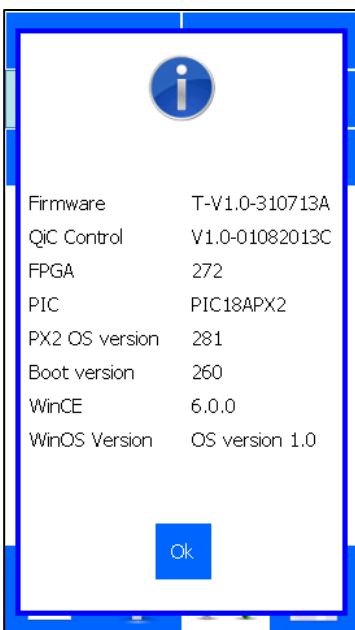

Fig. 9.7 Software and firmware version screen.

**Firmware** – the firmware that controls the main board.

**QiC Control** – the software that creates the user interface.

**FPGA** – the software that handles numerous functions in the system e.g. the printhead data.

**PIC** – the software that handles the timing and temperature of the printhead.

**PX2 OS version** – operating system of the main board.

**Boot version** – the software that makes it possible to upgrade the system through the ethernet connection.

**WinCE** – the software version of the Windows CE version running on the user interface hardware.

**WinOS Version** - the build version of the image that is used to flash the user interface hardware.

## Error

Touch the Error button to show the 10 most recent errors/warnings since the printer was switched on.



**Beware:**

When the controller is rebooted or switched off the error list will be cleared.



**Note:**

To view errors 4 to 10 touch the screen and drag the messages upwards. This will scroll them into view.



**Note:**

If an error occurs more than one time in a row, the error will only be displayed once. The amount of times an error has occurred sequentially will be mentioned between brackets, e.g. see Error 5 in Fig. 9.8.

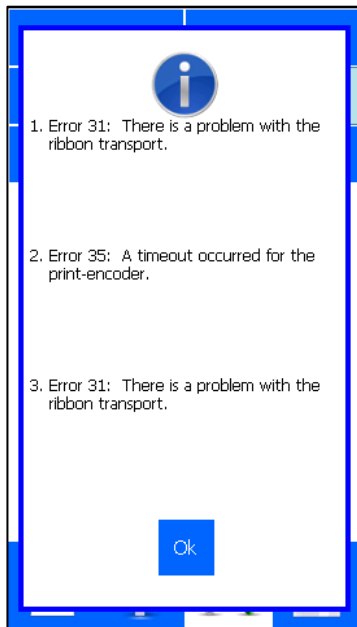

A

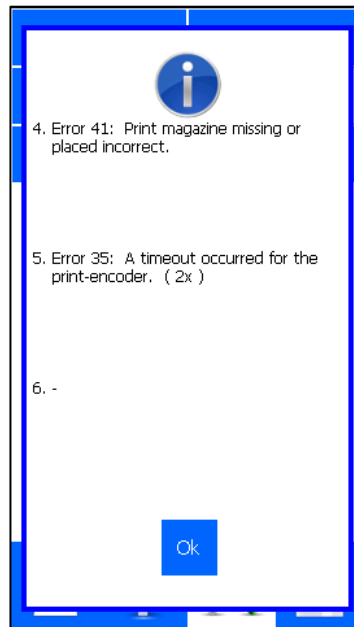

B

Fig. 9.8 Error-Warning list

Touch the *Ok* button to return to the Diagnostics menu.

### 9.1.3 Fonts

Touch *Fonts* to display the list of fonts that are installed in the printer.



**Beware:**

The font list must match the font list in the label design program used to design the labels. If a non installed font is used in the label as internal font the printer will not be printed at all. Due to this the printed label will miss one or more items. In the worse casem the label will not be printed at all and a range of error meqssages can ome up e.g. font error and no label loaded.



Fig. 9.9 Font list screen



**Note:**

The printer is supplied with a set of internal fonts installed. The fonts shown in the picture above are the pre-installed fonts. These fonts can be replaced by other fonts using QiC Draw.

The fonts shown on screen are those that should be used when using autocode variables inside labels. Autocodes are vaiables that can change between prints – e.g. date, time and counters.



**Beware:**

The pre-installed Arabic font may only be used for printing digits, e.g. for time, date and number items. As not all alphanumeric characters are available in the font, using the font for text will lead to characters not being printed.

### 9.1.4 Diagnostics

Touch *Diagnostics* to enter the diagnostics menu in which various system checks can be preformed.



**Beware:**

System Diagnostics should only be run when the system is paused. Often the tests require that the system air supply is attached. Only a trained service engineer should run these tests.

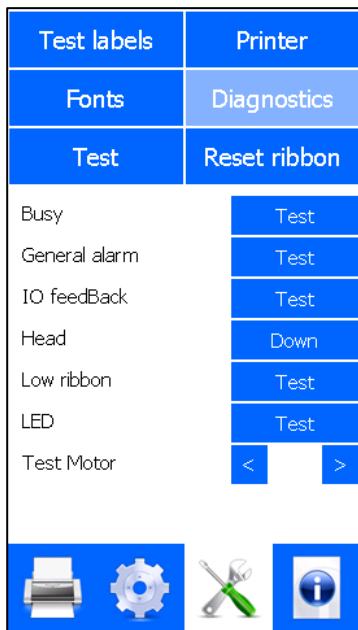

Fig. 9.10 Diagnostics menu

**Busy** – The busy output is activated for 2 seconds. This can be used to test whether the busy output is functioning. The output can be monitored on the host machine or a separate service tool.

**General alarm** - The General error output is activated for 2 seconds. This can be used to test whether the general alarm output is functioning. The output can be monitored on the host machine or a separate service tool.

**IO Feedback** - This button is used to test the most important internal (Ribbon sensor, Magazine latch and Front button) and external inputs (Print request signal, Trigger, External encoder, Remote front button and spare input of the control unit).

The internal inputs can be tested by activating these by following this method:

1. Magazine latch. Open en close the lever that unlocks the magazine and touch *IO feedback*.
2. Front button and Ribbon sensor. Press the front button. A print is made when the substrate is moving or it will create an underspeed error. Touching *IO feedback* should indicate *Yes* to these two items.



**Note:**

Since the front button and ribbon sensor are located in the coding unit, the possible problem could also be in the wiring to the control unit or a defective front button switch or ribbon sensor.

The external inputs can be checked using a service tool or attached peripheral device. To test the external inputs:

1. Activate the attached peripheral device (sensor or other device) and touch *IO feedback* or
2. Use a service device to activate the inputs.

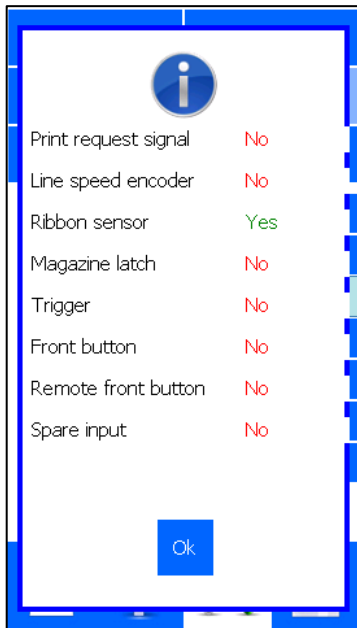

Fig. 9.11 IO feedback screen

**Head** - The head valve is activated for 2 seconds so the thermal printhead is driven downwards for 2 seconds. This can be used to test whether this assembly works fine.

**Low Ribbon** - The low ribbon/warning output is activated for 2 seconds. This can be used to test whether the Low Ribbon output is functioning. The output can be monitored on the host machine or a separate service tool.

**LED** - The printhead tri-colour LED is cycled through its colours: green, red and orange. This can be used to test whether the tri-colour LED is intact.

**Test motor** - The ribbon feed motor will be activated in either the rewind or wind direction.

## 9.1.5 Test

This function can be used to make test prints to verify and to optimize the print quality. This can be done with the current label but it is better to use a *Test label*, see section 9.1.1.

Touch *Test* to enter the menu that contains the print test functions.

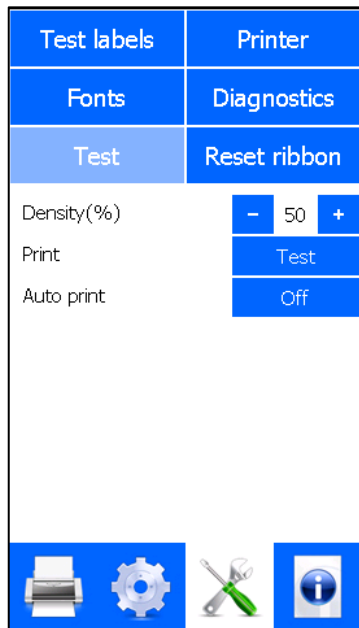

Fig. 9.12 Test menu

**Density** - Touch +/- to alter the contrast or heat applied to ribbon. Alternatively touch the value shown and enter the Density value through the numerical keyboard. This is useful to determine the correct density setting for the used substrate. Using a test label will also indicate whether the coding unit is mounted parallel to the platen roller.

**Print** - Touch the *Test* button to make a single print (make sure the substrate is moving).

**Auto print** - This puts the printer into a mode where pressing the front button on the coding unit once will cause the printer to print rapidly and repeatedly. To stop the print process press the front button again.

**Beware:**

The system will print as fast as possible with the current settings and label. This is very fast and should not be used often. To observe whether the printer is capable of reaching the maximum prints per minute is a useful test though. One can slow the number of prints per minute down by increasing the delay value. This is only a diagnostic function and should only be used by qualified personnel.

### 9.1.6 Reset Ribbon

This function should be used to reset the ribbon length whenever a new roll of ribbon is fitted to the printer. The ribbon length will be reset to the set *Ribbon length*, see section 8.6.2.

1. Touch the *Reset Ribbon* button to enter the reset ribbon menu.
2. Touch *Reset* to start the reset procedure.

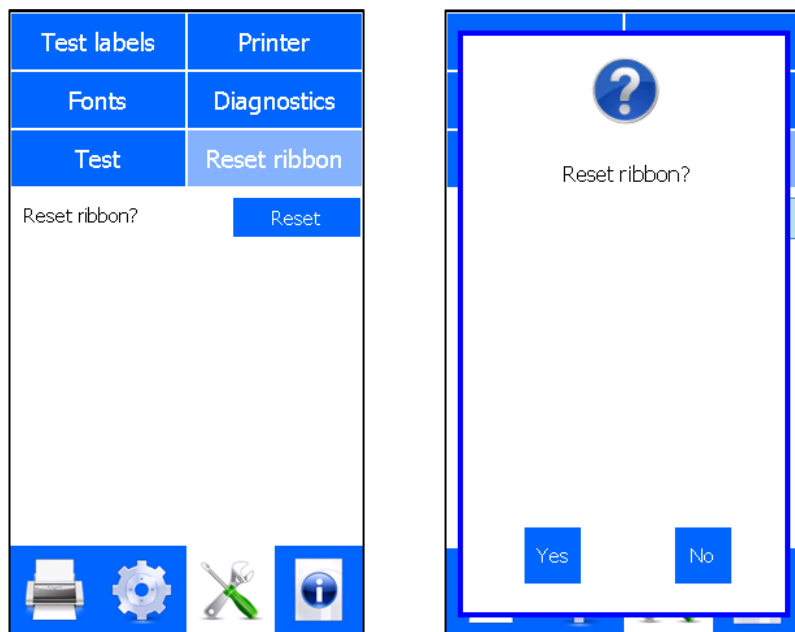

Fig. 9.13 Reset Ribbon menu

3. Touch Yes to confirm resetting of the ribbon length.

## 9.2 Information

Touch the *Information* icon located at the bottom of the screen.

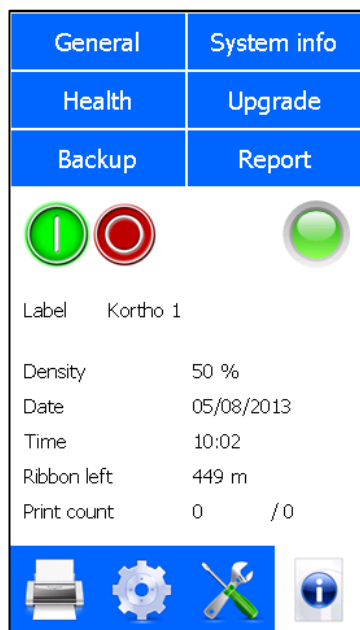

Fig. 9.14 Information menu



## 9.2.1 General

Touch the *General* button to display the information screen containing the general information.

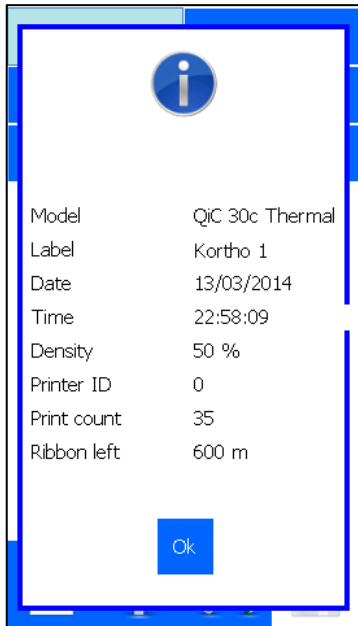

Fig. 9.15 General information screen

**Model** - model of the printer connected to the control unit.

**Label** - the name of the currently loaded label.

**Date** - system date of the control unit.

**Time** - system time of the control unit.

**Density** - the percentage of heat applied to the ribbon during printing.

**Printer ID** - the printer ID as defined by the user.

**Print count** - the total number of prints made with the current label, without changing to another label in between.

**Ribbon left** - the length of remaining ribbon on the magazine, measured in metres.

## 9.2.2 System Info

Touch the *System* button to display the information screen containing the system information.

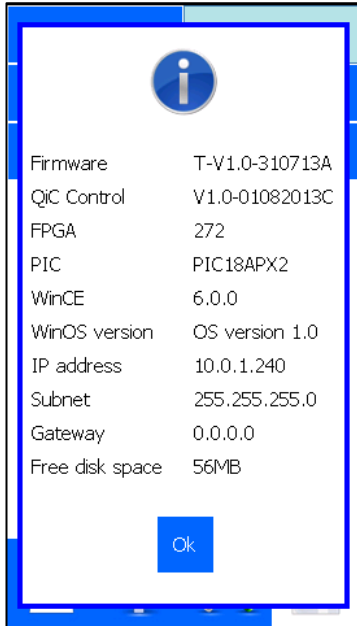

Fig. 9.16 System information screen

**Firmware** – the firmware that controls the main board.

**QiC Control** – the software that creates the user interface.

**FPGA** – the software that handles numerous functions in the system e.g. the printhead data.

**PIC** – the software that handles the timing and temperature of the printhead.

**WinCE** – the software version of the Windows CE version running on the user interface hardware.

**WinOS Version** - the build version of the image that is used to flash the user interface hardware.

**IP Address/Subnet/Gateway** – the set network address of the control unit.

**Free disk space** – the space that's still available for downloading new labels in the controller.

## 9.2.3 Health

Touch the *Health* button to show printing statistics.

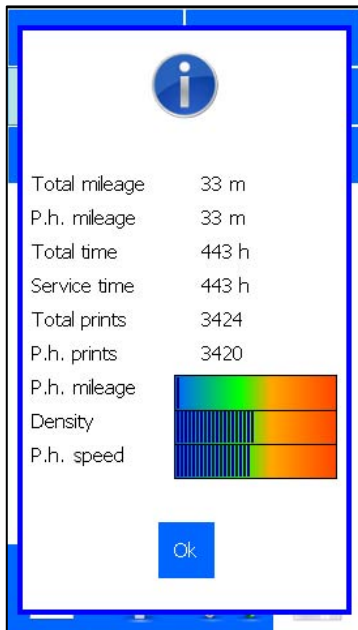

Fig. 9.17 Health screen

**Total mileage** - the total distance that the system has printed.

**P.h. mileage** - total distance the currently mounted print-head has printed. After changing the printhead this distance should be reset by using the QiC Draw program (Clear printhead mileage).

**Total time** - the total time the system has been switched on.

**Service time** - the time since the last service. During a service visit this time should be reset.

**Total prints** - the total number of prints the system has made.

**P.h prints** - the number of prints that the currently mounted printhead has made. After changing the printhead this number should be reset by using the QiC Draw program (Reset service).

**P.h. mileage** - a visual representation of how much distance the printhead has printed compared to the expected life of the printhead.

**Density** – a visual representation showing the current setting for heat applied to the ribbon during printing. Generally a lower density setting is resulting in a longer printhead life time.

**P.h. speed** – a visual representation showing the speed at which the printhead is printing. The speed shown is the speed of the last print made. Generally a lower speed is resulting in a longer printhead life time.

## 9.2.4 Upgrade

This function is used to upgrade the user interface software, QiC Control. To upgrade the software:

1. Insert a USB thumbdrive that contains the upgrade file (TsC12\*.CAB), located in the root of the drive.



**Note:**

Make sure only upgrade file of the QiC Control version that should be installed is present on the USB thumbdrive. Otherwise there is a chance that the wrong version will be installed.

2. Touch the *Upgrade* button, the following screen will be displayed.

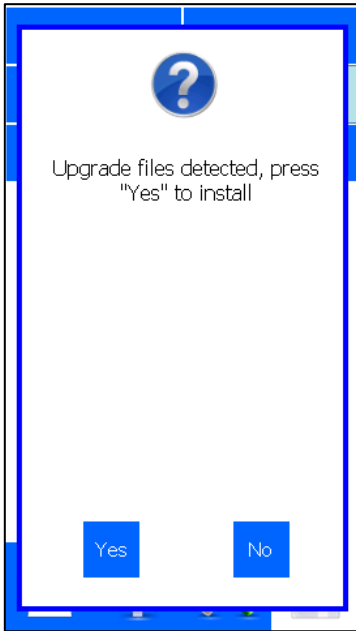

Fig. 9.18 Upgrade files detected screen

3. Touch the *Yes* button to start the upgrade process.

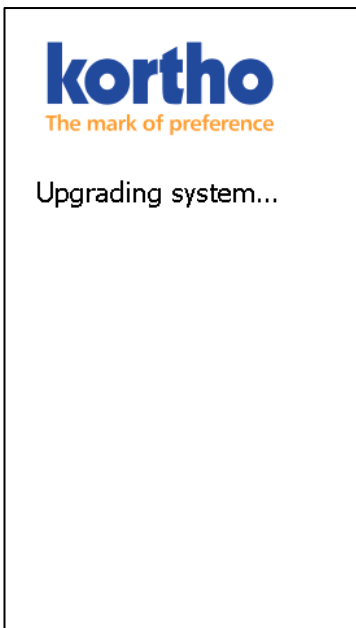

Fig. 9.19 Upgrade in progress screen

4. The system will upgrade in less than 20 seconds.
5. Reboot the system to finish the installation process.

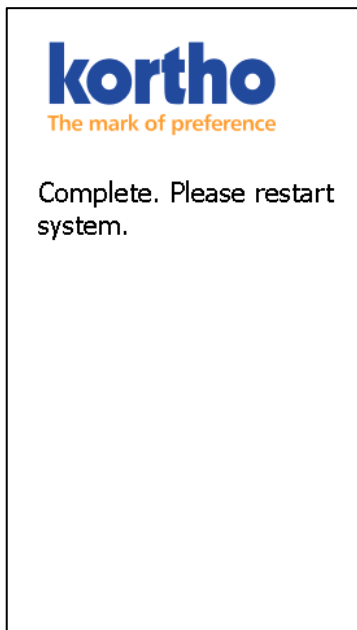

Fig. 9.20 Upgrade finished screen

## 9.2.5 Backup

This function backups the labels on the system onto a USB thumbdrive.

1. Insert a USB thumbdrive and wait for 4 seconds so it can be detected and mounted.
2. Touch the *Backup* button.
3. Enter a suitable name for the backup folder.

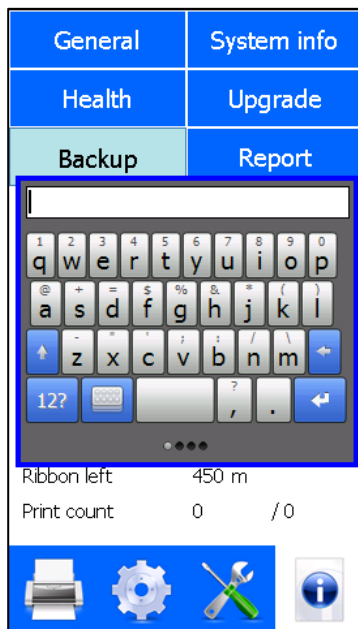

Fig. 9.21 Enter Backup name

4. Touch the *Enter* button to save the backup.
5. If the name already exists a file overwrite message will be displayed. Touch *Yes* and the backup file will be overwritten. Touch *No* and the backup operation will be cancelled.

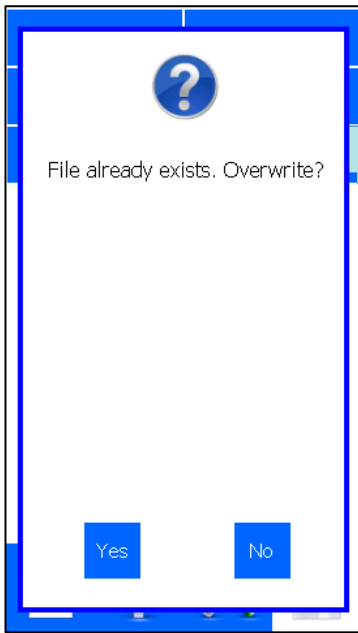

Fig. 9.22 Backup overwrite

6. While creating the backup folder and backing up the labels a timer icon will be shown on screen.

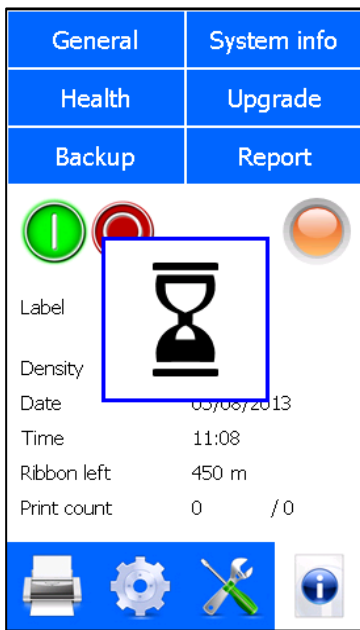

Fig. 9.23 Backup in progress

7. Wait until the message that the backup was successful appears on screen.

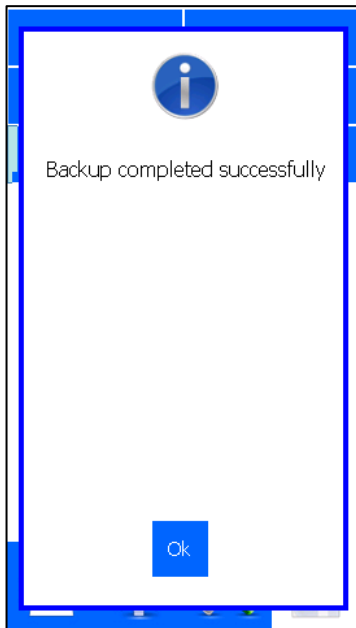

Fig. 9.24 Backup finished

8. Touch *Ok* to confirm and to return to the previous menu.
9. Remove the USB thumbdrive, the disk will contain a folder named "KorthoBackup\_<name>" (<xxx> being the name one has entered at step 3).

## 9.2.6 Report

This function generates a service report containing the printer settings and a scope trace file. This service report can either be opened as a text file or loaded into the service part of QiC Draw. The scope trace file can be opened in the oscilloscope function in the service part of QiC Draw.

When seeking assistance from Korthofah BV or your local distributor it is recommended that these two files are submitted.

To generate a report

1. Insert a USB thumbdrive and wait wait for 4 seconds so it can be detected and mounted.
2. Touch the *Report* button.
3. Enter a suitable <name> for the report.

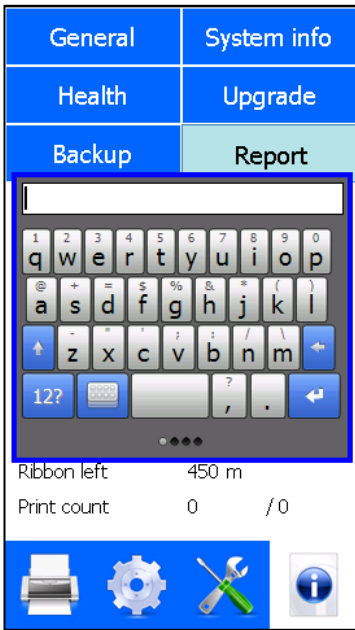

Fig. 9.25 Enter report name

4. Touch the *Enter* button to save the report.
5. If the name already exists a file overwrite message will be displayed. Touch *Yes* and the report files will be overwritten. Touch *No* and the report operation will be cancelled.

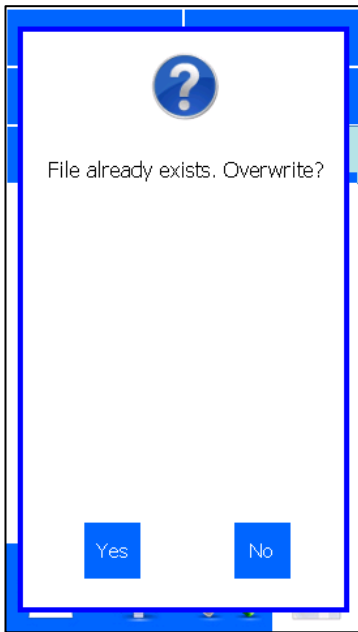

Fig. 9.26 Report overwrite

6. Wait until the message that the Report Saved appears on screen.



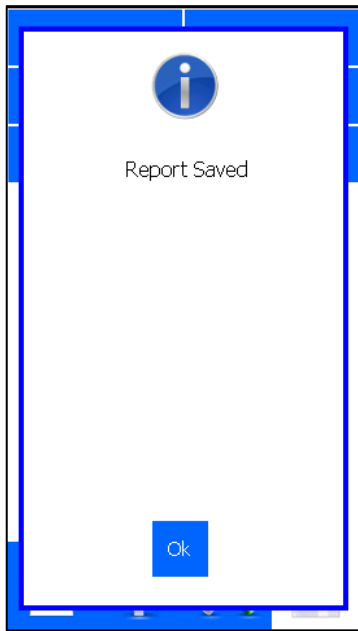

Fig. 9.27 Report saved

7. Touch *Ok* to confirm and to return to the previous menu.
8. Remove the USB thumbdrive, the disk will contain the files with the name names "KorthoReport\_<xxx>" for the service report and "Scope\_KorthoReport\_<xxx>" for the scope trace file (<xxx> being the name one has entered at step 3).

## 9.3 Screen calibration

If the screen calibration is not correct, the screen can be re-calibrated during the boot sequence of the control unit.

1. Touch the calibration screen which appears on screen just after the timer icon and just before the user interface starts up.
2. Follow the instructions on screen (touch the centre and the 4 corners).

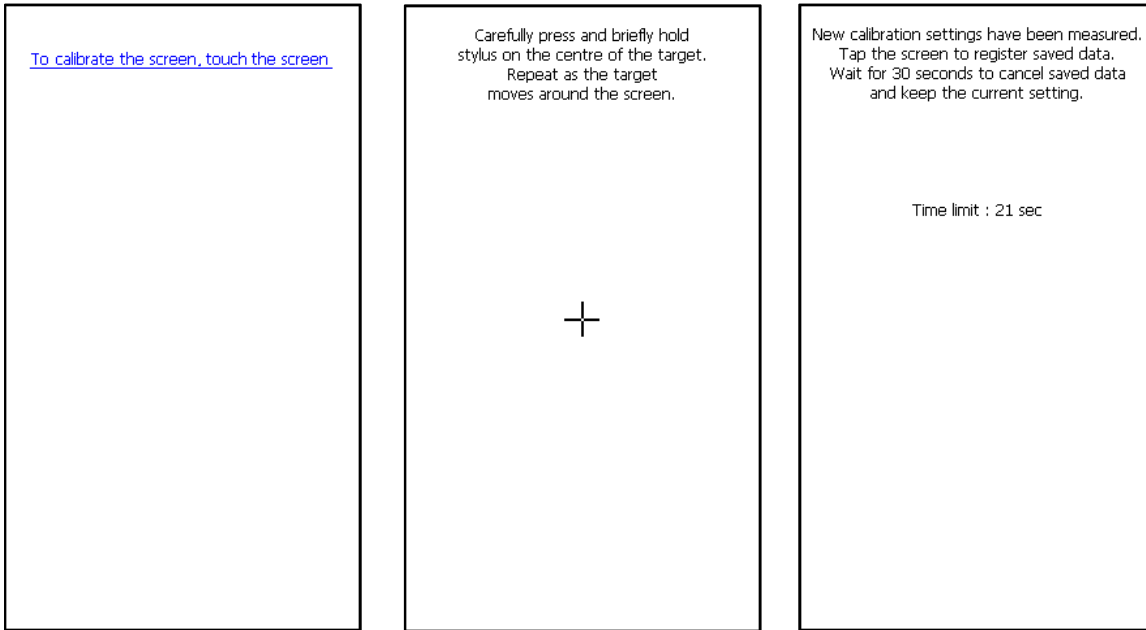

Fig. 9.28 Calibration screens

To confirm the new calibration settings, touch the screen. Alternatively wait for 30 seconds and the control unit will reload the previous calibration setting.

## 9.4 Fault finding

### 9.4.1 Control unit

Fault indication	Symptom(s)	Action(s)
Control unit does not power up.	Blue power LED on the coding unit remains off	Check whether the mains voltage is present. Check whether power cable is properly connected to the control unit and the mains power supply
	The user interface remains black	Check whether the power cable is not damaged. Check whether ON-OFF switch is in the position I.
	Ethernet LED's (visible at the back) remain off	<b>These actions should only be preformed by qualified personnel.</b> <b>Disconnect power cable (X1) from mains power supply first!</b>
		Check the fuses in the power entry module (X1). Check whether internal mains wiring is connected properly.
Control unit doesn't boot up.	Blue power LED on the coding unit is lit	<b>These actions should only be preformed by qualified personnel.</b> <b>Disconnect power cable (X1) from mains power supply first!</b>
	The user interface remains dark	Check whether the power cable of the user interface panel is properly connected. Check whether user interface panel-flat cable is not damaged. Check whether a "burning smell" is present in control unit. If so, contact your local dealer.
Control unit does not boot up.	Power LED on the coding unit is lit	<b>These actions should only be preformed by qualified personnel.</b> <b>Disconnect power cable (X1) from mains power supply first!</b>

## DIAGNOSTICS / TROUBLESHOOTING

	Touch screen is backlit	Check whether a "burning smell" is present in control unit. If so, contact your local dealer.
Touching the buttons on screen will not result in a proper response		The screen calibration is incorrect. Recalibrate the screen, see section 9.3.
The label cannot be downloaded to the system.		The label file on the USB thumbdrive may be corrupt. Ensure when transferring information that the flash device is removed properly. Check whether the label is ok by opening it in the labeldesign program. Alternatively create the label again and try to download it again. If the problem remains present contact technical support.
The font required cannot be downloaded to the system.		The font may be too large. Check with your supplier. The file on the USB thumbdrive may be corrupt. Ensure when transferring from a PC the USB thumbdrive is removed properly.
The label cannot be selected for printing		The label file stored in the label memory may be corrupt, download again. The label file stored in the print memory may be corrupt, select again. The fonts that are used for the text, date or time items in the label have not been installed.
The printer is not printing on request.		System is in pause mode (the red indicator is lit – warning is displayed on screen).  The number of prints has reached the value set in print count (the green status LED on the coding unit is flashing, the status screen shows the print count x / x)  Print request sensor (or cable) is defect or not sensing the product/mark.  System is in error mode (the orange LED on the coding unit is on and general alarm output is active).
A half roll of ribbon is left, but the QiC TsC12 advises it has run out of ribbon.	Low ribbon output is active and status LED is flashing orange.	Check the Ribbon length setting. The entered number of meters should correspond with the length of ribbon on the roll.
The roll of ribbon has been replaced but the setting is showing low.	Low ribbon output is active and status LED is flashing orange.	Reset the ribbon count.
Printer is showing an error or warning message.	Orange LED blinking	View the error/warning list for more information (Diagnostics - Printer – Errors).

The user interface is only showing a blank screen.		Reset the controller, by switching the control unit off and after 10 seconds on again.
--	--	--

**9.4.2 Coding unit**

<b>Fault indication</b>	<b>Symptom(s)</b>	<b>Action(s)</b>
The printer is showing a fault.	Orange LED on. An error message is displayed on the user interface.	Check the error displayed by the control unit.
It is hard to remove and/or to replace the magazine.		Check whether the guideposts are bent. If so the magazine may have been dropped and will need to be repaired or replaced.
After changing the ribbon the system does not print anymore.		Check whether the ribbon is placed correctly.
There is air leaking from the printer.		Check air fittings, tubes and connections to the printer. If the air leak seems to originate from within the coding unit, turn off the air and power and call for technical assistance.
The orange status LED is still shown even though the magazine has been placed back in position.		Press the button on the front of the coding unit to reset the error. The status light should turn green if a label is loaded. If not check the error displayed by the control unit.
It is hard to get the wound up ribbon from the rewind spool.		Check whether the rewind spool tension settings are Ok. Check whether the correct ribbon with plastic cores has been used (wall thickness 3mm).
Ribbon transport problem.		Ensure whether the ribbon has not broken or ran out. Check whether the ribbon is correctly routed on the magazine including around the ribbon sensor roller. Ensure that the magazine is fully inserted and secured when fitted to the printer.
Print missed.		Ensure that production line speed has not been increased and the substrate is running free. Check position of print sensor and the delay setting.

### 9.4.3 Print request signal sensor

Fault indication	Action(s)
Sensor does not detect passing product..	In case of a photocell: <ul style="list-style-type: none"> <li>- Check whether the lens (front side) of the photocell is clean.</li> <li>- Check whether the sensitivity of the photocell is properly set.</li> <li>- Check whether the photocell connector (X3) is properly connected to the control unit.</li> <li>- Check whether the photocell does not detect anything in the background. Normally, the LED indicator on the photocell is off if no substrate is present.</li> </ul>
	In case of a switch/relay/PLC contact: <ul style="list-style-type: none"> <li>- Check whether the interface cable connector (X3) is properly connected to the control unit.</li> <li>- Check whether the signal is really generated.</li> <li>- Check whether all wiring between sensor and control unit is mounted correctly.</li> </ul>

## 9.5 Error/warning messages

When problems occur the system will generally report an error message. The error message will be displayed on screen. As example see Fig. 9.29. Depending on the kind of error, the alarm output will also be set. Besides error messages the system will also report several warnings.

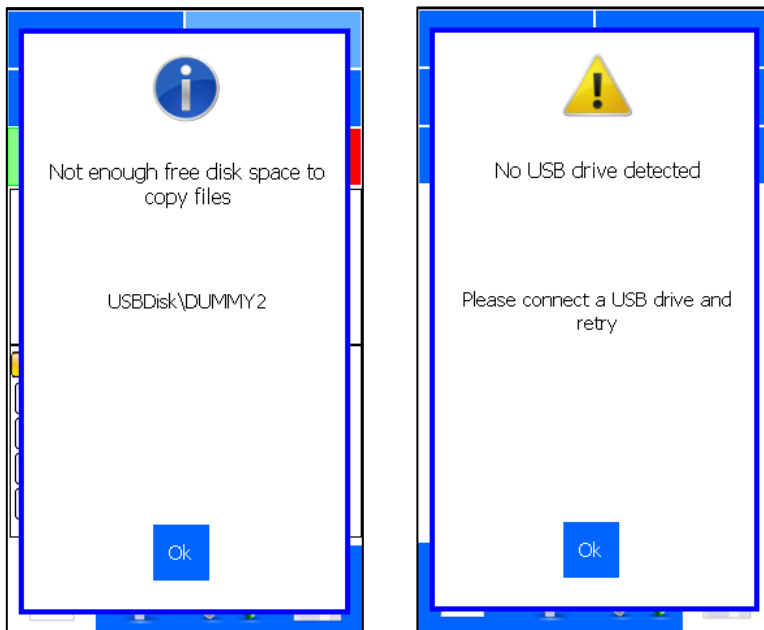

Fig. 9.29 Error and warning message

For a list of all the errors / warnings that can be generated, see Appendix G.

## 9.6 Poor print quality

Fault indication	Action(s)
Poor print quality in general.	Check the density. Check whether the coding unit is correctly mounted within its frame. Check whether the platen roller is not worn, is clean and is smooth. Also check for air bubbles within the platen roller. Check whether the ribbon used is suitable for the substrate to be printed. Check whether the ribbon is loaded correctly for the application i.e. ink side out. Verify whether the air pressure is set to the right pressure (between 0,1 and 0,2MPa). Check whether the substrate is moving at a stable speed.
Parts of the label are missing and white lines appear within the printed label.	Check whether the printhead has been cleaned recently. Check whether the printhead has some damaged pixels and requires replacing. Check whether the platen roller surface is clean. Check whether the platen roller surface is not damaged, otherwise replace it. Check whether the substrate is moving at a stable speed.
Labels are only partially printed.	Check whether the prints on the ribbon are overlapping. If so, check whether the ribbon core notches engage with the magazine. Check whether the coding unit is correctly mounted within its frame.
The ribbon width has been changed from 35mm to 55mm as a wider label needs to be printed. The printed labels shows faint areas about 35mm apart.	The printhead has been worn out on the edges due to the narrower ribbon and requires replacing.
The contrast of the printed label is decreasing as it is printed	Check whether the coding unit is not mounted in its frame correctly. Check whether the coding unit is level and that the gap between the thermal printhead and platen roller is no more than 3mm. Verify whether the air pressure is set to right pressure (between 0,1 and 0,2 MPa).
The labels are not being printed at the correct position.	Check whether a timing or print request signal issue affects the setup. Check whether the delay setting is either too low or too high. Check whether the substrate adjustment roller is correctly positioned. Ask for technical assistance if the problem remains.

# 10 MAINTENANCE

The family of QiC printers are designed specifically for robust operation and include unique patented mechanisms and systems to ensure long uninterrupted service. Key to ensuring optimal operation and extended life is appropriate maintenance. It is important to inspect the printer visually and check the print quality both on a regular basis.

The periods of maintenance are based on an average factory environment in which the printers are installed. Depending on the actual circumstances the periods of maintenance may vary.

This section covers the routinely maintenance that can be easily performed by the user.

## 10.1 Daily maintenance



### WARNING:

Turn off power before performing maintenance tasks.

To ensure a good print quality it is recommended to check the items as mentioned in this section everyday.

### 10.1.1 Printhead

To ensure the printer is printing effectively it is important to clean the printhead regularly.



### CAUTION:

Under NO circumstances should a sharp tool be used across the fragile printing head. Any damage caused by sharp object will void the warranty.

To clean the printhead remove the magazine and place the printhead in his upwards position. Clean the printhead with a cleaning swab or lint free cloth soaked in isopropanol (2-propanol or isopropylalcohol (IPA)). Wipe the heater line surface as marked in the Fig. 10.1.

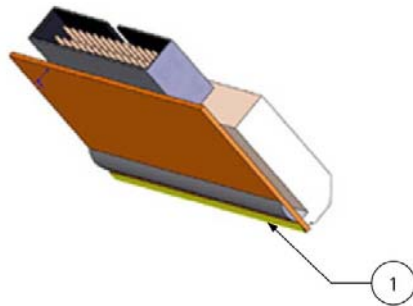

1. Heater line surface (on the edge of the thermal printhead)

Fig. 10.1 Cleaning the printhead

Check the print for missing lines. The printhead is constructed using extremely small thermal heaters (12 per millimetre). Eventually these individual heaters become worn resulting in missing lines. Replace the printhead if required.



### CAUTION:

Before removing the printhead the power and air should be disconnected. All maintenance should be carried out by qualified personnel, preferably those that have attended the formal training session offered by Korthofah. Refer to section 10.5.

### 10.1.2 Platen roller

It is important that there are no indentations or debris in or on the platen roller material, as this will cause poor prints and can damage the printhead.

Over long periods of time or use it may be necessary to change the platen roller due to deterioration of the rubber material.



**Note:**

Occasionally repositioning the printer can average the wear and increase the life span of the platen roller.

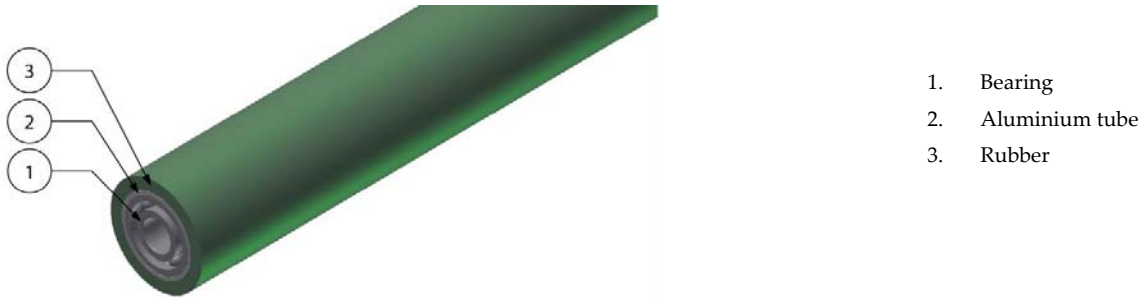

Fig. 10.2 Platen roller

## 10.2 Maintenance after replacing the ribbon roll

Each time the ribbon roll needs to be replaced the magazine needs to be cleaned.

Clean the ribbon movement sensor roller, ribbon transport roller and the pressure roller with a cleaning swab or lint free cloth soaked in isopropanol (2-propanol or isopropylalcohol (IPA)) to remove debris, dirt and dust.



Fig. 10.3 Magazine cleaning

Make sure the pressure roller can move freely and firmly towards the ribbon movement sensor roller. Clean the pressure roller arm if required.



## 10.3 Weekly maintenance

It is recommended that the system is cleaned and that all connections are checked once a week. In addition the water separator of the air reduction valve should be monitored for the presence of water content. In that case, one should relieve the water from the water separator by pressing the shutoff valve at the bottom of the water separator.

The Health check monitor should be used to ensure the system remains in good condition.

## 10.4 Half yearly maintenance



**WARNING:**

When removing covers all air and mains power should be disconnected.

Every year the rear cover should be removed to check the condition of the cables and remove any debris, dirt and dust.

To prevent loss of production it is advisable to service the printer once a year. Only service engineers, qualified by Korthofah BV, are allowed to service the printer.

## 10.5 Printhead replacement



**WARNING:**

The mains power and air supply must be disconnected when replacing the printhead.



**CAUTION:**

Read subsection 10.5.1 before handling the thermal printhead. Always ensure anti-static precautions are observed when handling a thermal printhead or printed circuits boards or they might get damaged.

### 10.5.1 Printhead safety notes

The enclosed thermal printhead is a static sensitive device.

In order to avoid potential damage to the Printhead please ensure anti-static precautions are observed throughout the installation procedure.

Korthofah cannot be held responsible for damage to the printhead caused by mishandling.

#### **Before installing the printhead, please adhere to these precautions:**

- Ensure that the printer is switched off and isolated from the mains supply.
- Discharge yourself before handling the equipment (a grounding wrist strap should be used).
- Do not touch any components on the printhead with your hand or any other conductive equipment.
- Do not touch the heater line surface with bare hands to avoid corrosion.
- Do not place the equipment on or near materials such as Styrofoam, plastic and vinyl. Keep printhead in anti-static bag used for transporting until ready to fit.

### Other useful precautions:

- Residue on heater line should be removed with ethanol or isopropanol in order to avoid extensive wear.
- Adjust the coding unit to have an even pressure across the width of the printhead.
- Use ribbon which is free from Na+, K+, and Cl- ions.
- Use ribbon which is designed to reduce the friction between the printhead and the ribbon.
- Use a ribbon which is designed not to generate static voltages.
- The printhead should be free from any condensation to avoid corrosion.

### 10.5.2 Printhead replacement

1. Use a 2.5mm Allen key to remove the two screws holding the printhead in place.



**Note:**

Removing the air pressure allows the head to lower and provide easier access to the two screws.

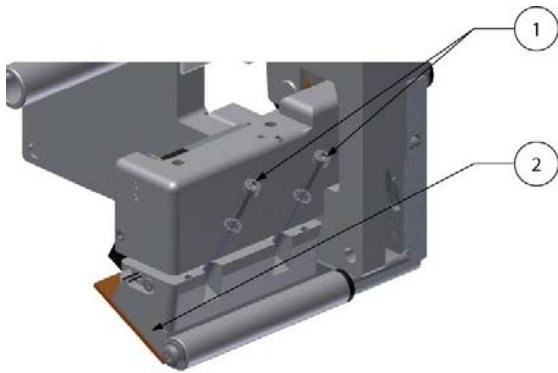

1. Printhead screw
2. Printhead

Fig. 10.4 Removing thermal printhead screws

2. Take the connector clamp (1 in Fig. 10.5) from the cable connector.
3. Disconnect the cable plug from the thermal printhead socket.



**CAUTION:**

The cable plug should be gently taken out of the printhead socket taking care not to pull directly on the wires.

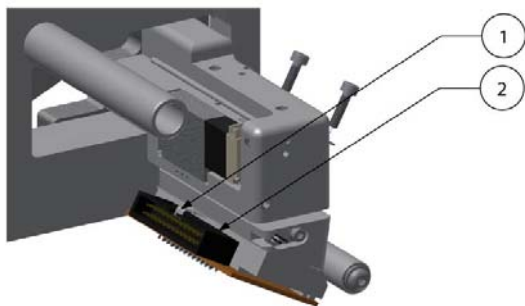

1. Connector clamp
2. Printhead connector

Fig. 10.5 Disconnect the cable plug form the printhead socket

4. Note the printhead resistance value identified on the new printhead.
5. Refit the new printhead, reversing the steps 1 to 3. Ensure the cable plug is firmly replaced in the printhead connector taking care not to bend any connector pins. Ensure the lockclip of the connector is in place.

**CAUTION:**

Make sure the connector is secured by the connector clamp (2).

6. Switch on the system and adjust the printhead resistance value, see section 8.6.2, before making any print.

## 10.6 Updating firmware and software

The firmware and software can be updated. Only the user interface software can be updated by the user, see section 9.2.4. Only service engineers, qualified by Korthofah BV, are allowed to update the other software and firmware versions.



# 11 DISMANTLING & DISPOSAL

At the end of the technical lifetime of the system it should be dismantled and disposed according to local regulations. The general guide line to do so is described.

## 11.1 Dismantling

Separate the printer parts in this order:

### 11.1.1 System

1. Switch off the system.
2. Unplug the mains power cable.
3. Disconnect all remaining connections from the control unit.
4. Remove the supports.
5. Separate the supports from the coding unit and the control unit.

### 11.1.2 Coding unit

1. Open the backcover of the coding unit.
2. Remove the printed circuit board.
3. Remove the LED's, wireloom, carriage encoder module and the foil encoder.
4. Remove the printhead.
5. Treat the printed circuit board and the printhead as electronic waste.

### 11.1.3 Control unit

1. Open the control unit.
2. Remove the printed circuit boards.
3. Remove the touch panel.
4. Remove the LED's, net-entry and wirelooms.
5. Remove the power supplies.
6. Treat the printed circuit boards and power supplies as electronic waste.

### 11.1.4 Sensor devices

1. Treat the photocell as electronic waste.

### 11.1.5 Ribbon

1. Treat as mentioned in the most recent MSDS, which can be obtained at Korthofah BV.

## 11.2 Disposal

### 11.2.1 Disposal method

The disposal method must be in accordance with national and local regulations at the time of the disposal.

The user is responsible for the disposal of:

1. The printer at the end of its operational life.
2. Waste ribbon and unused ribbon at the end of the printer's operational life.
3. Packaging.

### 11.2.2 Waste separation

Please deliver the packaging materials to waste recycling companies.

Printed circuit boards, power supplies, touch panel, net-entrée, encoders and wirelooms are considered electronic waste, because poisons found in electronic waste include lead, mercury, cadmium, and brominated flame-retardants commonly added to plastics used in electronics. As the system is RoHS compliant the amount of hazardous materials mentioned above will be limited.

The remaining materials consist mainly of anodized aluminium and stainless steel.

The ribbon should be treated separately according to the method as mentioned in the most recent MSDS.

The remaining materials must also be delivered to waste recycling companies.

# Index

## ■ Keywords

### A

anti-static 10-3

### B

bitmap 3-1

bracket 1-2, 6-1, 6-2, 6-3, 6-4, 6-5

### C

coding unit 1-2, 1-5, 2-1, 2-3, 3-2, 3-3, 3-4, 4-1, 4-2, 5-1, 5-2, 6-1, 6-2, 6-3, 6-5, 7-1, 7-3, 7-4, 8-1, 8-6, 8-19, 9-2, 9-7, 9-9, 9-20, 9-21, 9-22, 9-24, 10-4, 11-1

control unit 1-1, 1-3, 2-1, 2-3, 3-1, 3-2, 3-3, 3-4, 4-1, 4-2, 5-2, 6-2, 6-5, 7-3, 7-4, 8-1, 8-20, 9-3, 9-4, 9-7, 9-11, 9-12, 9-19, 9-20, 9-21, 9-22, 9-23, 11-1

### D

debounce 8-27

### E

electrostatic 1-5, 4-3

### F

firmware 3-4, 3-9, 8-25, 9-4, 9-5, 9-12, 10-5

front button 3-4, 8-12, 8-13, 9-2, 9-7, 9-9

function 8-1, 8-9, 8-10, 8-11, 8-18, 8-19, 8-20, 8-21, 8-22, 8-25, 8-26, 9-2, 9-8, 9-9, 9-13, 9-15, 9-17

button 3-2, 3-4, 3-5, 3-6, 3-7, 3-8, 7-3, 7-4, 8-1, 8-2, 8-6, 8-7, 8-10, 8-12, 8-14, 8-15, 8-16, 8-17, 8-18, 8-19, 8-20, 8-21, 8-23, 8-24, 8-25, 8-26, 9-1, 9-2, 9-3, 9-4, 9-5, 9-7, 9-9, 9-11, 9-12, 9-13, 9-14, 9-15, 9-17, 9-18, 9-21, 9-22

### H

handling 3-2, 4-3, 5-1, 5-2, 5-3, 8-12, 10-3

host 1-1, 1-3, 2-1, 3-1, 4-1, 4-2, 6-1, 6-3, 6-5, 8-21, 9-7, 9-8

humidity 1-2, 1-3, 8-27

### I

image 9-5, 9-12

index 2-3

indicator 3-2, 3-3, 9-21, 9-23

ink 1-3, 5-3, 9-24

interface 1-3, 3-2, 4-2, 6-5, 7-3, 8-15, 8-17, 9-5, 9-12, 9-13, 9-19, 9-20, 9-22, 9-23, 10-5

### M

magazine 2-3, 3-2, 3-4, 6-1, 7-1, 7-2, 7-4, 8-12, 8-13, 8-19, 9-4, 9-7, 9-11, 9-22, 9-24, 10-1, 10-2

maintenance 1-1, 1-4, 3-2, 6-3, 10-1, 10-3

memory 1-1, 1-4, 2-1, 7-5, 8-8, 8-9

label 1-1, 1-4, 8-6, 8-7, 8-8, 9-21

print 1-1, 1-4, 3-1, 9-21

menu structure 3-2, 3-9

### O

operator 1-1, 1-3, 1-4, 3-2, 3-4, 6-5, 8-2, 8-3, 8-4, 8-5, 8-6, 8-17, 8-19

orientation 8-16, 8-17, 8-25

### P

parameter 8-1, 8-22

## INDEX

---

date	1-1, 1-4, 2-1, 3-1, 7-3, 8-4, 8-14, 8-18, 9-2, 9-4, 9-6, 9-11, 9-21
delay	8-26
direction	8-25
language	7-3, 8-15, 8-16
speed	1-3, 3-1, 6-3, 6-4, 8-22, 8-26, 8-27, 9-13, 9-22, 9-24
time	1-1, 1-3, 1-4, 2-1, 3-1, 3-2, 5-1, 5-2, 7-3, 8-5, 8-14, 8-18, 8-22, 8-27, 9-5, 9-6, 9-11, 9-13, 9-21, 10-2
platen	2-1, 3-2, 6-3, 6-4, 7-2, 7-3, 7-4, 7-5, 9-9, 9-24, 10-2
platen roller	2-1, 3-2, 6-3, 6-4, 7-2, 7-3, 7-4, 7-5, 9-9, 9-24, 10-2
power supply	1-3, 4-1, 4-2, 9-3, 9-20
precautions	4-3, 10-3, 10-4
print	
cycle	2-1, 3-1, 6-1, 7-3, 8-22, 8-27
test	1-4, 3-2, 8-12, 9-8
printhead	1-3, 1-4, 1-5, 2-1, 2-3, 3-1, 3-2, 3-3, 3-4, 4-3, 5-1, 5-2, 6-1, 6-2, 6-4, 7-2, 7-3, 7-4, 7-5, 8-6, 8-19, 8-20, 8-21, 8-27, 9-3, 9-5, 9-8, 9-12, 9-13, 9-24, 10-1, 10-2, 10-3, 10-4, 10-5, 11-1
product	4-1, 5-2, 5-3, 8-21, 8-22, 8-25, 8-27, 9-21, 9-23
protection	1-1, 1-3
<b>Q</b>	
qualified	1-1, 9-9, 9-20, 10-1, 10-3, 10-5
<b>R</b>	
ribbon	1-2, 1-3, 2-1, 2-3, 2-4, 3-1, 3-2, 3-4, 5-3, 6-1, 6-5, 7-1, 7-4, 8-13, 8-19, 8-20, 8-22, 8-27, 9-4, 9-7, 9-8, 9-9, 9-10, 9-11, 9-13, 9-21, 9-22, 9-24, 10-2, 10-4
<b>S</b>	
safety	10-3
SELV	1-3, 4-2
sensor	2-1, 7-1, 8-13, 8-21, 9-3, 9-7, 9-21, 9-22, 9-23, 10-2
encoder	3-1, 4-2, 6-3, 6-4, 6-5, 8-22, 9-7, 11-1
photocell	3-1, 6-1, 9-23
storage	5-2, 5-3
substrate	1-3, 1-5, 2-1, 2-3, 2-4, 3-1, 3-2, 6-1, 6-3, 6-4, 6-5, 7-1, 7-3, 7-4, 8-2, 8-12, 8-20, 8-21, 8-22, 8-26, 8-27, 9-7, 9-9, 9-22, 9-23, 9-24
symbol	
note	2-6, 4-2, 6-1, 7-4, 8-1, 8-2, 8-7, 8-12, 8-15, 8-17, 8-27, 9-5, 9-6, 9-7, 9-13, 10-2, 10-4
warning	10-1, 10-3
<b>T</b>	
temperature	1-2, 1-3, 3-2, 3-4, 5-2, 7-4, 8-20, 8-27, 9-3, 9-5, 9-12
touch screen	3-2
transport	5-1, 5-2, 5-3, 8-20, 9-22, 10-2
trigger	3-4, 8-22
request	2-1, 3-1, 6-1, 6-4, 8-1, 8-2, 8-17, 8-22, 8-23, 8-26, 8-27, 9-24
<b>V</b>	
voltage	1-3, 4-1, 4-2, 9-3, 9-20
<b>W</b>	
waste	8-20, 11-1



## ■ Figures

Fig. 1.1	Coding units, global dimensions.....	1-2
Fig. 1.2	Control unit, global dimensions.....	1-2
Fig. 1.3	Ribbon.....	1-3
Fig. 2.1	The printer system.....	2-1
Fig. 2.2	Coding unit, parts.....	2-2
Fig. 2.3	Coding unit, interior parts front.....	2-2
Fig. 2.4	Magazine, parts.....	2-2
Fig. 2.5	Coding unit, interior parts back.....	2-3
Fig. 2.6	Coding unit model selection.....	2-3
Fig. 2.7	Control unit + adjustable support.....	2-4
Fig. 2.8	Control unit, connections.....	2-4
Fig. 2.9	Air regulator.....	2-5
Fig. 2.10	QiC Draw main window.....	2-5
Fig. 3.1	Screen layout, main menu portrait.....	3-3
Fig. 3.2	Screen layout, main menu landscape.....	3-3
Fig. 3.3	LED indicators and front button.....	3-4
Fig. 3.4	First keyboard screen.....	3-5
Fig. 3.5	First keyboard screen, alternative alphanumerics.....	3-5
Fig. 3.6	Second keyboard screen, numerics and special characters.....	3-6
Fig. 3.7	Third keyboard screen, commonly used text.....	3-6
Fig. 3.8	Programming third keyboard screen buttons, entering text.....	3-7
Fig. 3.9	Programming third keyboard screen buttons, entering text.....	3-7
Fig. 3.10	Fourth keyboard screen, edit text and use cursor controls.....	3-8
Fig. 3.11	Numeric keyboard.....	3-8
Fig. 3.12	Entering the System information screen.....	3-9
Fig. 3.13	Standard menu structure.....	3-9
Fig. 4.1	Control unit identification label.....	4-1
Fig. 4.2	Power supply information.....	4-1
Fig. 4.3	Attention label for opening control unit.....	4-2
Fig. 5.1	Shipping and handling labels.....	5-1
Fig. 6.1	Coding unit QiC 53c.....	6-2
Fig. 6.2	Control unit TsC12.....	6-2
Fig. 6.3	Positioning of the print.....	6-3
Fig. 6.4	Substrate adjustment.....	6-4
Fig. 7.1	Ribbon magazine.....	7-1
Fig. 7.2	Ribbon path label.....	7-1
Fig. 7.3	Adjustment of printhead gap.....	7-2
Fig. 7.4	Coding unit adjustment block.....	7-3
Fig. 7.5	Grid test label printed with incorrect alignment of printhead and platen roller (density 40%).....	7-4
Fig. 7.6	Grid test label printed with correct alignment of printhead and platen roller (density 40%).....	7-5
Fig. 7.7	Grid test label printed with correct alignment of printhead and platen roller (density 60%).....	7-5
Fig. 7.8	Printer parameters, default and user values.....	7-5
Fig. 7.9	Printer environment information.....	7-6
Fig. 8.1	Main menu.....	8-1
Fig. 8.2	Main menu.....	8-2
Fig. 8.3	Text item input menu.....	8-3
Fig. 8.4	Date advance input menu.....	8-4
Fig. 8.5	Number start value input menu.....	8-5
Fig. 8.6	Select label menu.....	8-6
Fig. 8.7	Copy label menu, USB thumbdrive.....	8-7
Fig. 8.8	Copy label menu, label memory.....	8-7
Fig. 8.9	Overwriting label message.....	8-8
Fig. 8.10	Copy label(s) failed message.....	8-8
Fig. 8.11	Insufficient memory message.....	8-9
Fig. 8.12	Move label menu.....	8-9
Fig. 8.13	Paste label menu.....	8-10
Fig. 8.14	Delete label menu.....	8-10
Fig. 8.15	Delete label message.....	8-11
Fig. 8.16	Preview screen.....	8-11
Fig. 8.17	Unlock magazine.....	8-12
Fig. 8.18	Lock magazine.....	8-12

## INDEX

---

Fig. 8.19	Ribbon path .....	8-13
Fig. 8.20	Settings menu .....	8-13
Fig. 8.21	System settings menu .....	8-14
Fig. 8.22	Date and Time menu .....	8-14
Fig. 8.23	System language selection menu .....	8-15
Fig. 8.24	Reboot message screen .....	8-15
Fig. 8.25	Date Language selection menu .....	8-16
Fig. 8.26	Screen orientation selection menu .....	8-16
Fig. 8.27	Reboot message screen .....	8-17
Fig. 8.28	Screensaver selection menu .....	8-18
Fig. 8.29	Rollover hour selection menu .....	8-18
Fig. 8.30	System settings menu .....	8-19
Fig. 8.31	Print head resistance .....	8-20
Fig. 8.32	Signal settings menu .....	8-21
Fig. 8.33	Network settings menu .....	8-23
Fig. 8.34	Network settings, IP address .....	8-24
Fig. 8.35	Label settings menu .....	8-24
Fig. 8.36	Orientation setting selection .....	8-25
Fig. 8.37	Orientation setting .....	8-26
Fig. 8.38	Print settings menu .....	8-26
Fig. 9.1	Diagnostics menu .....	9-1
Fig. 9.2	Test label menu .....	9-2
Fig. 9.3	Test label menu .....	9-2
Fig. 9.4	Printer main menu .....	9-3
Fig. 9.5	Printer diagnostics screen .....	9-3
Fig. 9.6	System informatuion screen .....	9-4
Fig. 9.7	Software and firmware version screen .....	9-4
Fig. 9.8	Error-Warning list .....	9-5
Fig. 9.9	Font list screen .....	9-6
Fig. 9.10	Diagnostics menu .....	9-7
Fig. 9.11	IO feedback screen .....	9-8
Fig. 9.12	Test menu .....	9-9
Fig. 9.13	Reset Ribbon menu .....	9-10
Fig. 9.14	Information menu .....	9-10
Fig. 9.15	General information screen .....	9-11
Fig. 9.16	System information screen .....	9-12
Fig. 9.17	Health screen .....	9-13
Fig. 9.18	Upgrade files detected screen .....	9-14
Fig. 9.19	Upgrade in progress screen .....	9-14
Fig. 9.20	Upgrade finished screen .....	9-15
Fig. 9.21	Enter Backup name .....	9-15
Fig. 9.22	Backup overwrite .....	9-16
Fig. 9.23	Backup in progress .....	9-16
Fig. 9.24	Backup finished .....	9-17
Fig. 9.25	Enter report name .....	9-18
Fig. 9.26	Report overwrite .....	9-18
Fig. 9.27	Report saved .....	9-19
Fig. 9.28	Calibration screens .....	9-20
Fig. 9.29	Error and warning message .....	9-23
Fig. 10.1	Cleaning the printhead .....	10-1
Fig. 10.2	Platen roller .....	10-2
Fig. 10.3	Magazine cleaning .....	10-2
Fig. 10.4	Removing thermal printhead screws .....	10-4
Fig. 10.5	Disconnect the cable plug form the printhead socket .....	10-4

# Appendix A Specifications

---

## Coding Unit

### Dimensions

Height	196mm
Width	166mm
Depth	210mm

<b>Weight</b>	6,1 kg
---------------	--------

### Print area

Width	53mm
Length	200mm

<b>Print speed</b>	2,7 - 25m/min
--------------------	---------------

<b>Print head</b>	12 dots/mm (300 dpi)
-------------------	----------------------

<b>Substrate</b>	Synthetic foils (PP, PET, PE) and coated papers
------------------	---

### Environment

Temperature	5 °C - 40 °C (41 °F - 104 °F)
Relative humidity	10% - 90% (non condensing)

## Control unit

### Dimensions

Height	186mm
Width	198mm
Depth	239mm

<b>Weight</b>	3,3 kg
---------------	--------

### Power supply

Input voltage	90-132VAC – 180-264VAC
Frequency	47 – 63 Hz
Power	max. 130VA
Inrush current	<62A at 115VAC      <135A at 230VAC

### Environment

Temperature	5 °C - 40 °C (41 °F - 104 °F)
Relative humidity	10% - 90% (non condensing)

Interface	USB port Ethernet connection Optically isolated Inputs: print request, trigger, remote front button Optically isolated outputs: general alarm, busy, low ribbon / warning, spare output
-----------	--

## Ribbon

### Operational

Temperature (recommended) 10 °C – 30°C (50°F - 86 °F)

### Transport and storage

Temperature 10°C - 30 °C (50 °F - 86 °F)

Precautions store in original packaging away from direct sunlight

Shelf life 12 months

## Label features

### Label

- Name: User defined name. Optional a description and author can be added.
- Test label: Default label, which is useful for checking the print quality and correct setting of several parameters.
- Items: Text, multiple line text, number, date, time, shiftcode, barcode, line, circle/oval and box items and graphics. These items are placed in a label using the label design program.
- Data: Fixed and variable.
- Size: Maximal 96kB.

### Font

- Internal: 6 fonts are preinstalled; Liberation Sans, Liberation Serif, Tahoma, Century Gothic, Arial black and ArabDigit Black. In addition extra fonts can be stored. The system offers full downloadable font support for Windows TrueType fonts. The font ArabDigit Black can only be used for Arabic digits, e.g. time, date and numbers. The other internal fonts can be used to print fixed and variable text e.g. time, date, operator input text, see section 9.1.3.
- External: fonts used in a label that will be treated as fixed data/text. When using external font in the label design program QiC Draw, the actual printable bitmaps of the characters is generated and stored in the label, including the original entered text so that editing in QiC Draw remains possible.

### Barcode formats

Australian Post Customer 2, Australian Post Customer 3, Australian Post Redirection, Australian Post Reply Paid, Australian Post Routing, Australian Post Standard Customer, Codabar(2 widths), Codablock-F, Code 11, Code 2 of 5 Data Logic, Code 2 of 5 IATA, Code 2 of 5 Industrial, Code 2 of 5 Matrix, Code 2 of 5, Code 3 of 9 (Code39) Ascii, Code 3 of 9 (Code39), Code 93 Ascii, Code 93, Code128 (Subset A), Code128 (Subset B), Code128 (Subset C), Code128, Data Matrix, Deutsche Post Identcode, Deutsche Post Leitcode, EAN128,EAN13 - 2 digits add on, EAN13 - 5 digits add on, EAN13, EAN-14, EAN8 - 2 digits add on, EAN8 - 5 digits add on,EAN8, Flattermarken, Interleaved 2 of 5, ISBN Code (=EAN13P5), Japanese Postal Code, Korean Postal Authority Code, LOGMARS, MaxiCode, Micro PDF417,MSI code, NVE-18, PDF417 Truncated, PDF417, Pharmacentralnumber, Pharmacode OneTrack, Pharmacode TwoTrack, Planet 12 digits, Planet 14 digits, Plessey code, PostNet-10 (ZIP + 4 + Check digit), PostNet-11 (ZIP + 4 + 2), PostNet-12 (ZIP + 4 + 2 + Check digit), PostNet-5 (ZIP 5 digits), PostNet-6 (ZIP 5 digits + Check digit), PostNet-9 (ZIP + 4), QR-Code, Royal Mail 4 State (RM4SCC), RSS Expanded, RSS Limited, RSS-14 Expanded Stacked, RSS-14 Stacked Omnidirectional, RSS-14 Stacked, RSS-14 Truncated, RSS-14, SSCC18, Telepen Alpha, UCC 128(=EAN128), UPC A - 2 digits add on, UPC A - 5 digits add on, UPC A, UPC E - 2 digits add on, UPC E - 5 digits add on, UPC E, UPC12 Digits (this list contains barcodes available in combination with QiC Draw. The list can vary when using another label design program).

## APPENDIX A, SPECIFICATIONS

---

### Items

- Graphic: Depending on the label design program used. Genaraly in jpg, jpeg or bmp format (black/white).
- Dynamic: Number, date, time and shiftcode.
- Operator input: Text, start value of a counter/number, offset of a date.

**Label download** Through Ethernet or a USB thumbdrive.

**Storage capacity** The control unit memory size for storing labels is 55MB (approximately 570 labels of the maximum label size).



# Appendix B      Dimensions

---

Coding unit ..... B-2  
Control unit ..... B-3  
Standard bracket ..... B-4

Coding unit

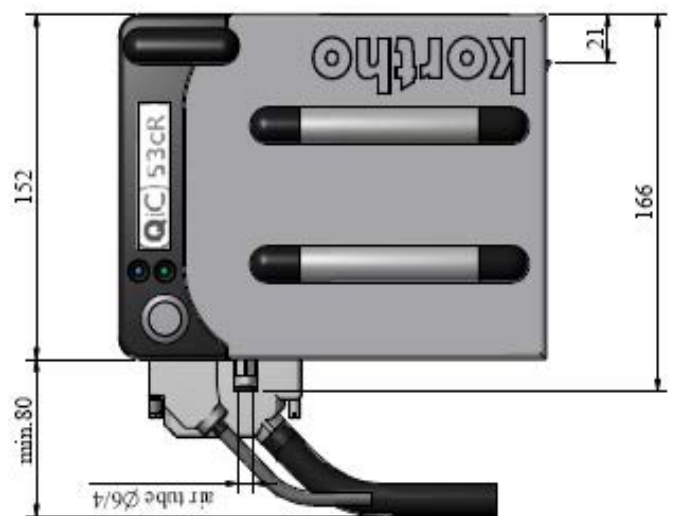
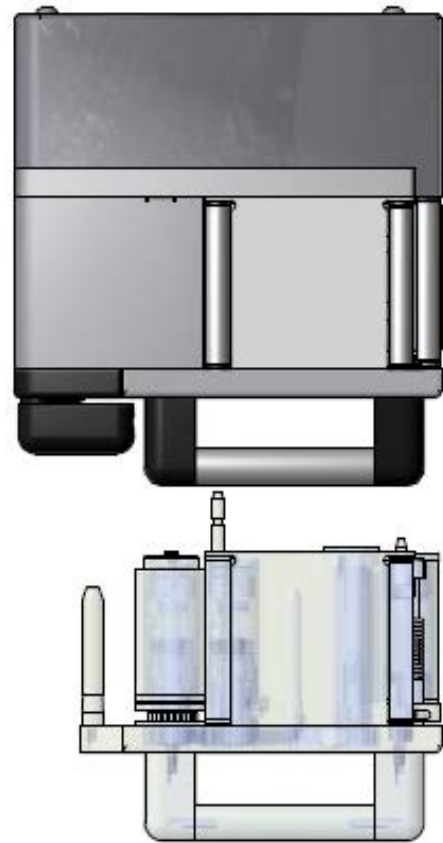
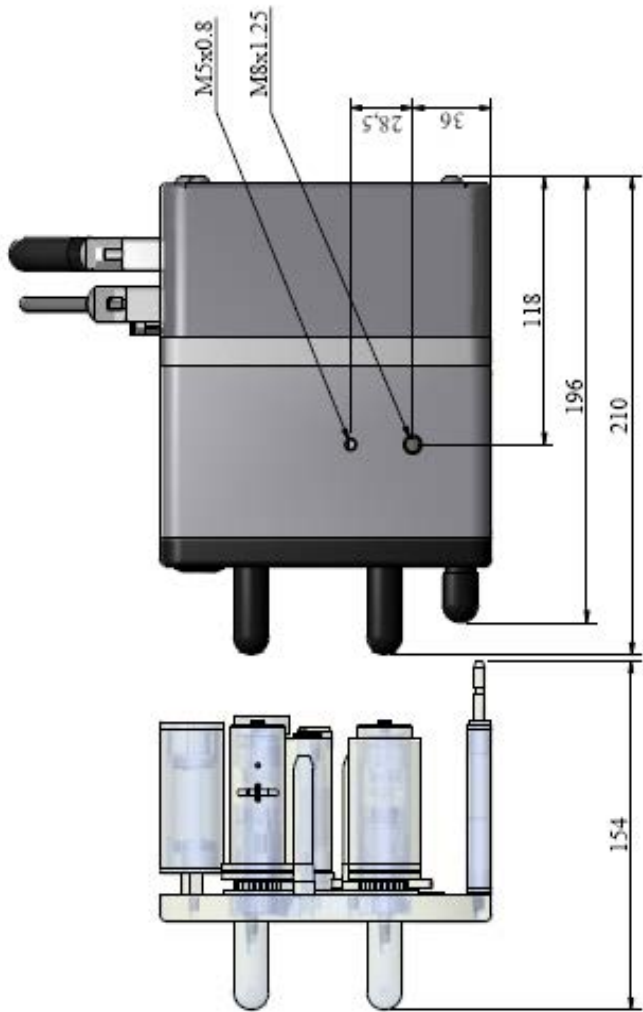

Dimensions are metric [mm]



### Control unit

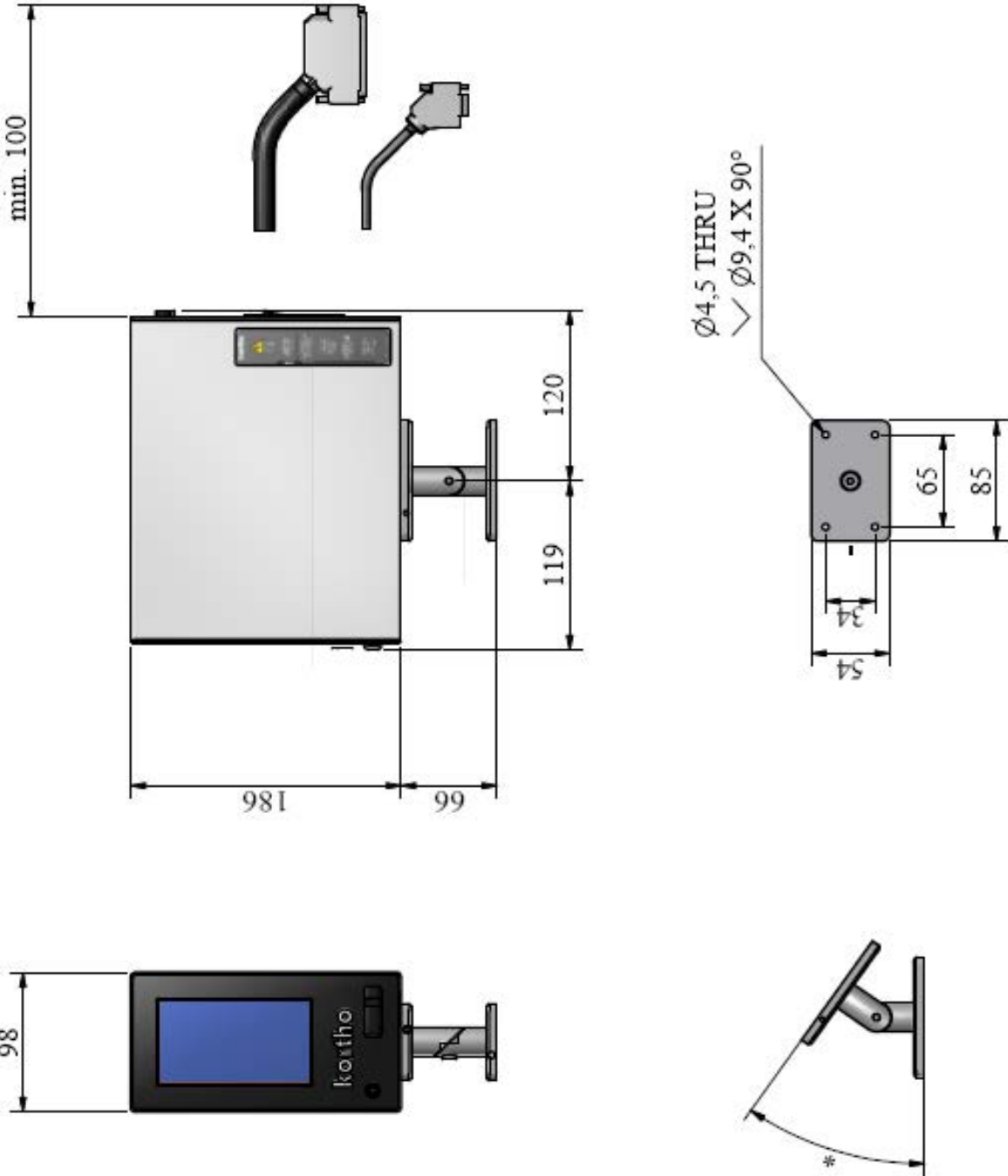

Dimensions are metric [mm]

Standard bracket

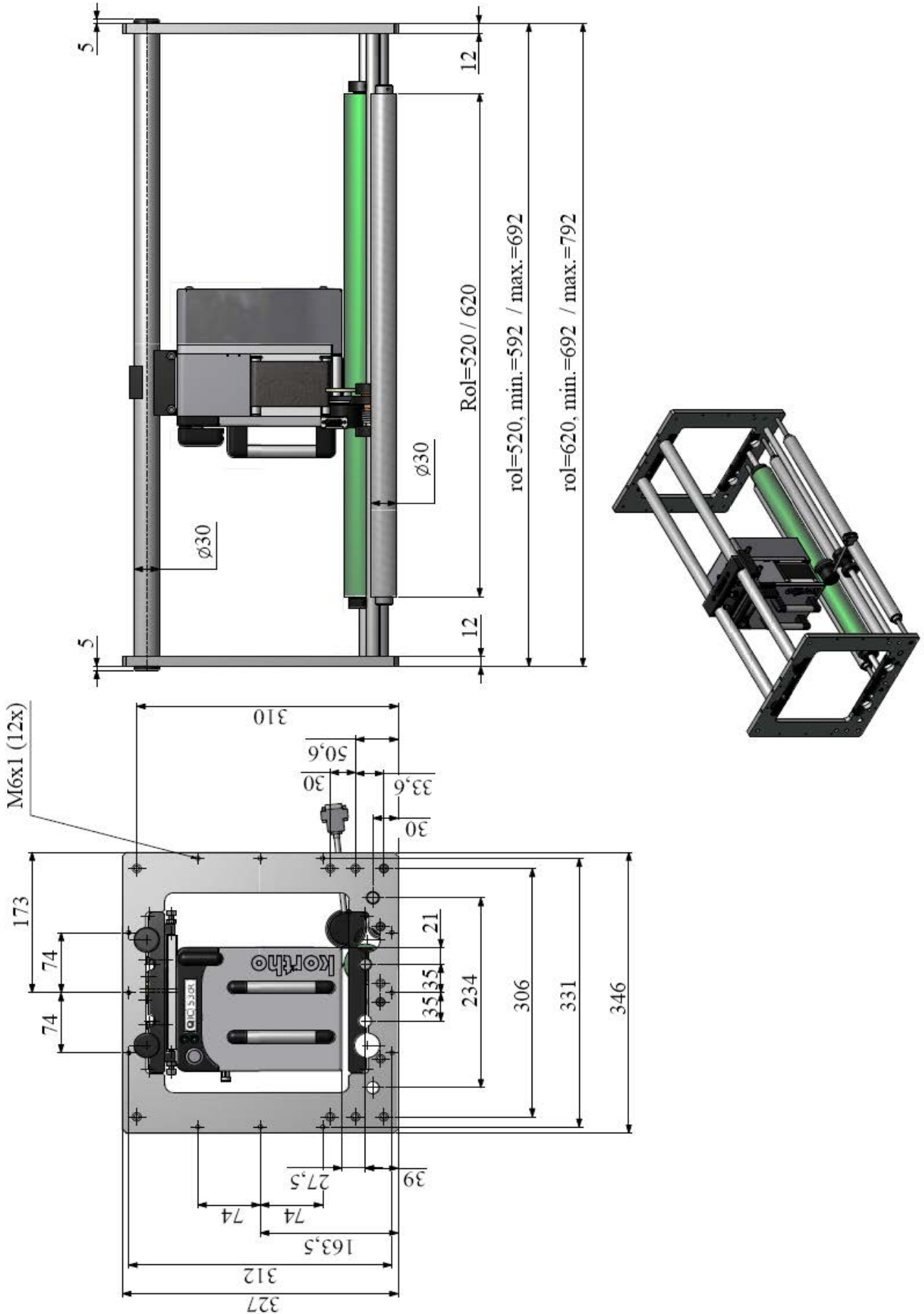

Dimensions are metric [mm]

# Appendix C      Part lists & illustrations

---

- Coding unit ..... C-2
  - Coding unit drawing A ..... C-2
  - Coding unit, drawing B ..... C-4
  - Magazine 53c ..... C-6
  - Printhead cylinder ..... C-8
- Control unit..... C-10
  - Control unit..... C-10

## Coding unit

### Coding unit drawing A

816559 / 816378			Coding unit CI / Cr		
<b>Drawing A</b>					
Line	Part no.	Description	Line	Part no.	Description
1	160659	Straight screw coupling M5x6	6	815299	PCB coding unit QiC
2	165871	Printhead QiC 30/53	7	816254	Heating element D=4; 48V-10W
3	324281	Guard coding unit QiC 53cR	8	816365	Magazine QiC 30cR
4	324949	Guard coding unit QiC 53cL	9	816547	Magazine QiC 30cL
5	815261	Cable internal coding unit QiC			

# APPENDIX C, PART LISTS & ILLUSTRATIONS

Coding unit drawing A

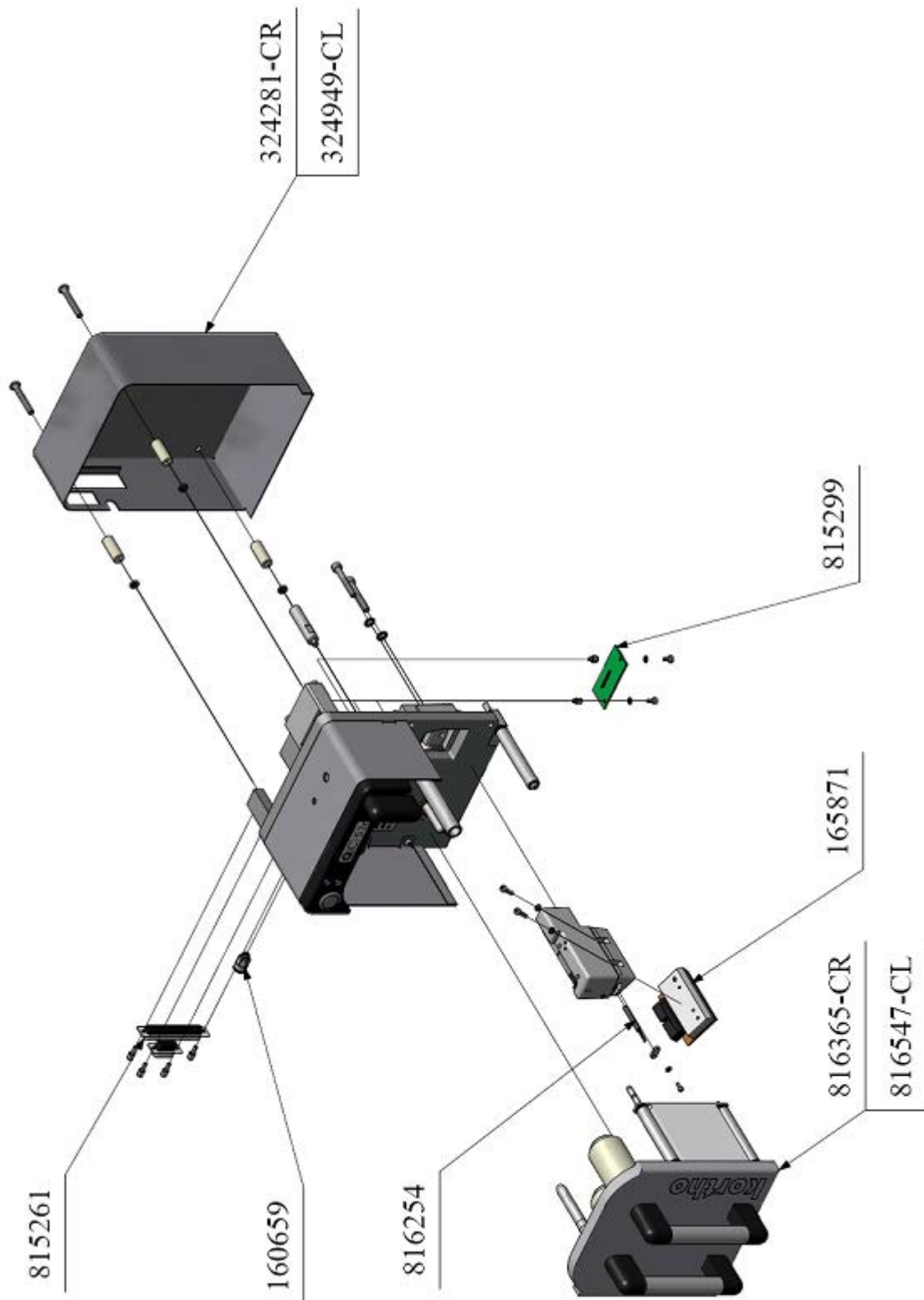

## Coding unit, drawing B

816559 / 816378			Coding unit CI / Cr		
Drawing B					
Line	Part no.	Description	Line	Part no.	Description
1	165311	LED tri colour, 2VDC, QiC	8	815932	Cable magazing/switch QiC 53/107
2	1654324	LED blue, 5VDC, QiC	9	816394	Pulley Z18 QiC C
3	165448	Push button QiC	10	816422	Pulley Z18 QiC cR
4	167102	Nut M4 St.St.	11	816435	Bearing block QiC cR
5	167452	Stepper motor QiC	12	816492	End of ribbon sensor QiC C
6	167481	Timing belt B=6, Z=92, QiC	13	816562	Pulley Z18 QiC cL
7	815611	Roller foil guide QiC 30/53	14	816575	Bearing block QiC cL

# APPENDIX C, PART LISTS & ILLUSTRATIONS

Coding unit, drawing B

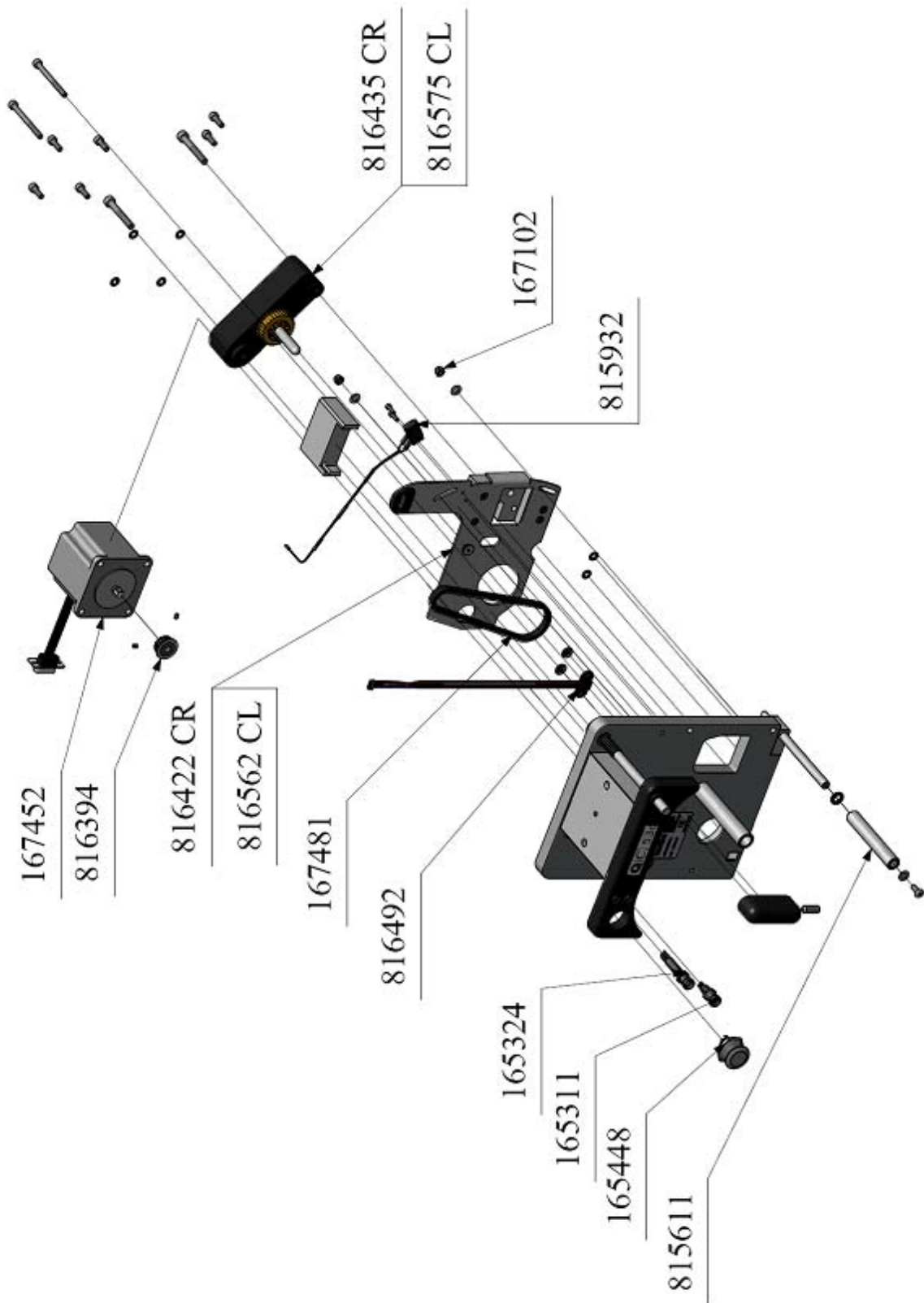

**Magazine 53c**

<b>816365 / 816547</b>			<b>Magazine QiC Cr /CI</b>		
<b>Line</b>	<b>Part no.</b>	<b>Description</b>	<b>Line</b>	<b>Part no.</b>	<b>Description</b>
1	166221	Torsion spring magazine QiC cL	8	167618	Ball bearing 16/8x6 2Z
2	166892	Core Qic 30/53	9	167647	Torsion spring magazine QiC cR
3	167494	Timing beld B=6, Z=1-06, QiC C	10	815611	Roller foilguide QiC 30/53
4	167507	Freewheel coupling 18/12x26	11	816448	Drive roller QiC cR
5	167519	Axiaallager 16/8x3,5	12	816451	Rewinding rol QiC C
6	167522	Ring axiaallager 16/8x3,5	13	816477	Roller foul encoder QiC C
7	167548	Freewheel coupling 8/4x8	14	816731	Drive roller QiC cL



# APPENDIX C, PART LISTS & ILLUSTRATIONS

Magazine 53c

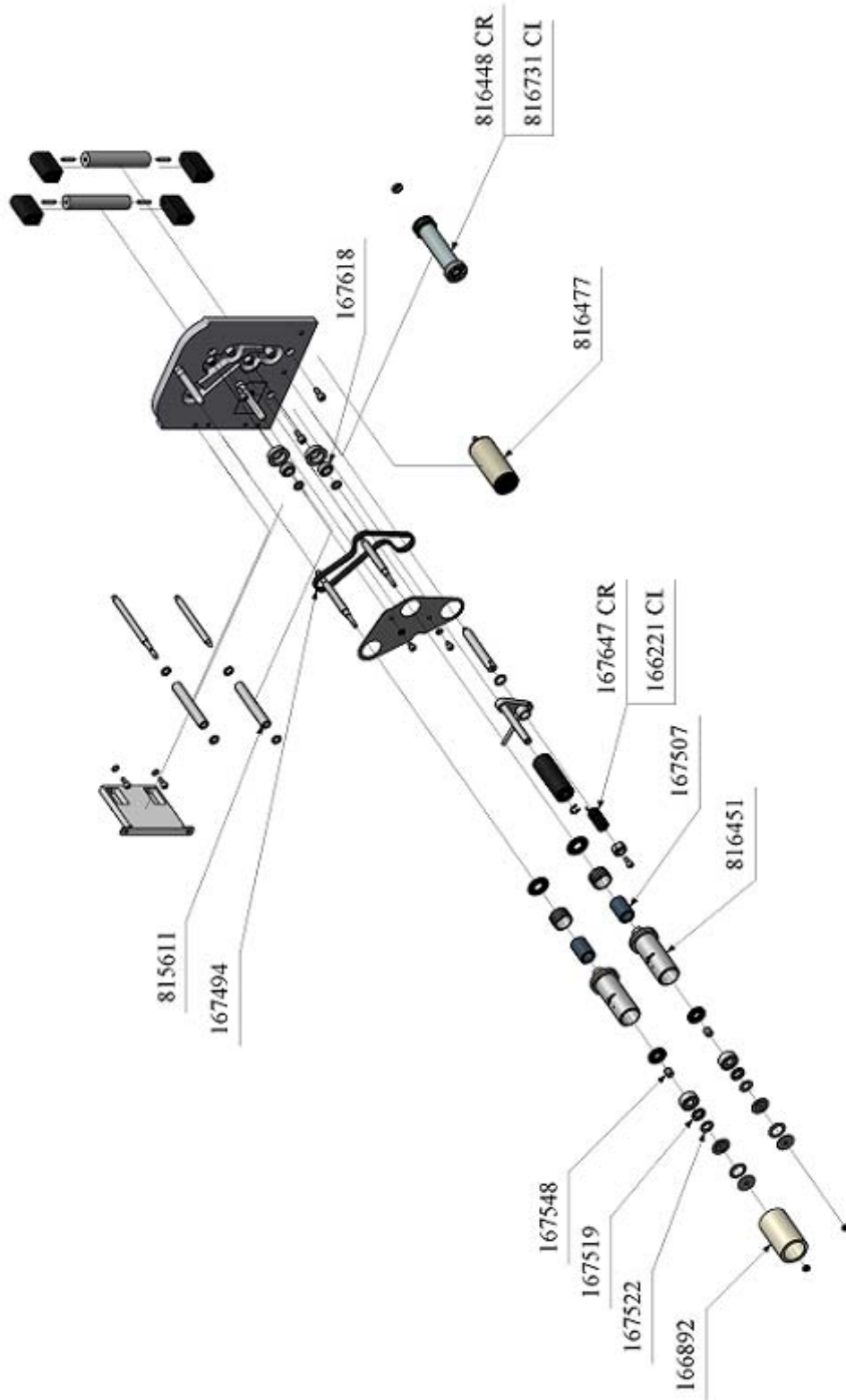

**Printhead cylinder**

815328			Printhead cilinder		
Line	Part no.	Description	Line	Part no.	Description
1	165772	O-ring 8,0x1,5 Viton	3	165982	Solenoid valve QiC
2	165897	O-ring 11,0x1,5 Viton	4		

Printhead

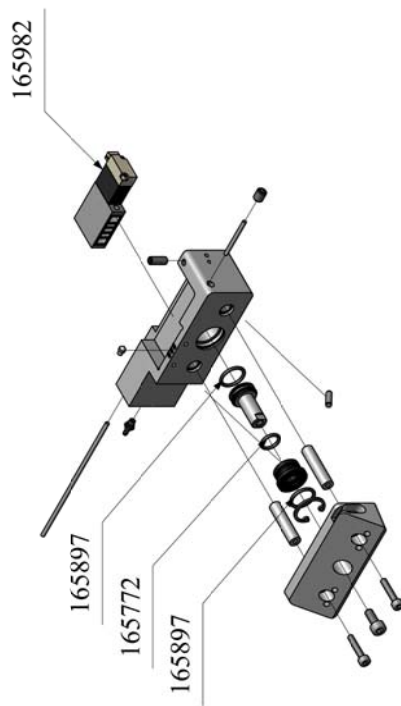

## Control unit

## Control unit

817345			Control box TsC12		
Line	Part no.	Description	Line	Part no.	Description
1	154178	Fuse 0,5A	12	325735	Gasket TsC12
2	155972	Fuse 3,15A	13	323132	Flap USB CB TsC26
3	166135	Stylus	14	815891	USB connector TsC12 QiC
4	166275	Power supply 48V	15	816015	Support controlbox TsC8
5	166682	Transistor clip TsC26	16	816604	CCU PX2 incl. software
6	166695	Isolation strip TsC26	17	816925	Main cable TsC12, L=2,5
7	167172	LED green, 24VDC, QiC	18	816769	Cable intern encoder QiC
8	167185	Fuse holder panel, QiC	19	816925	Main cable TsC12, L=2,5
9	167971	Touch panel TsC12	20	817049	Power supply 5/12/24 VDC, QiC
10	167984	PCB TX28, TsC12	21	817052	Cable power supply/PX2 TsC8
11	168054	Filter control box 3A	22	817065	Cable power supply/Filter QiC
12	322041	Gasket cover TsC8	23	817399	Serieel cable TsC12

# APPENDIX C, PART LISTS & ILLUSTRATIONS

## Control unit

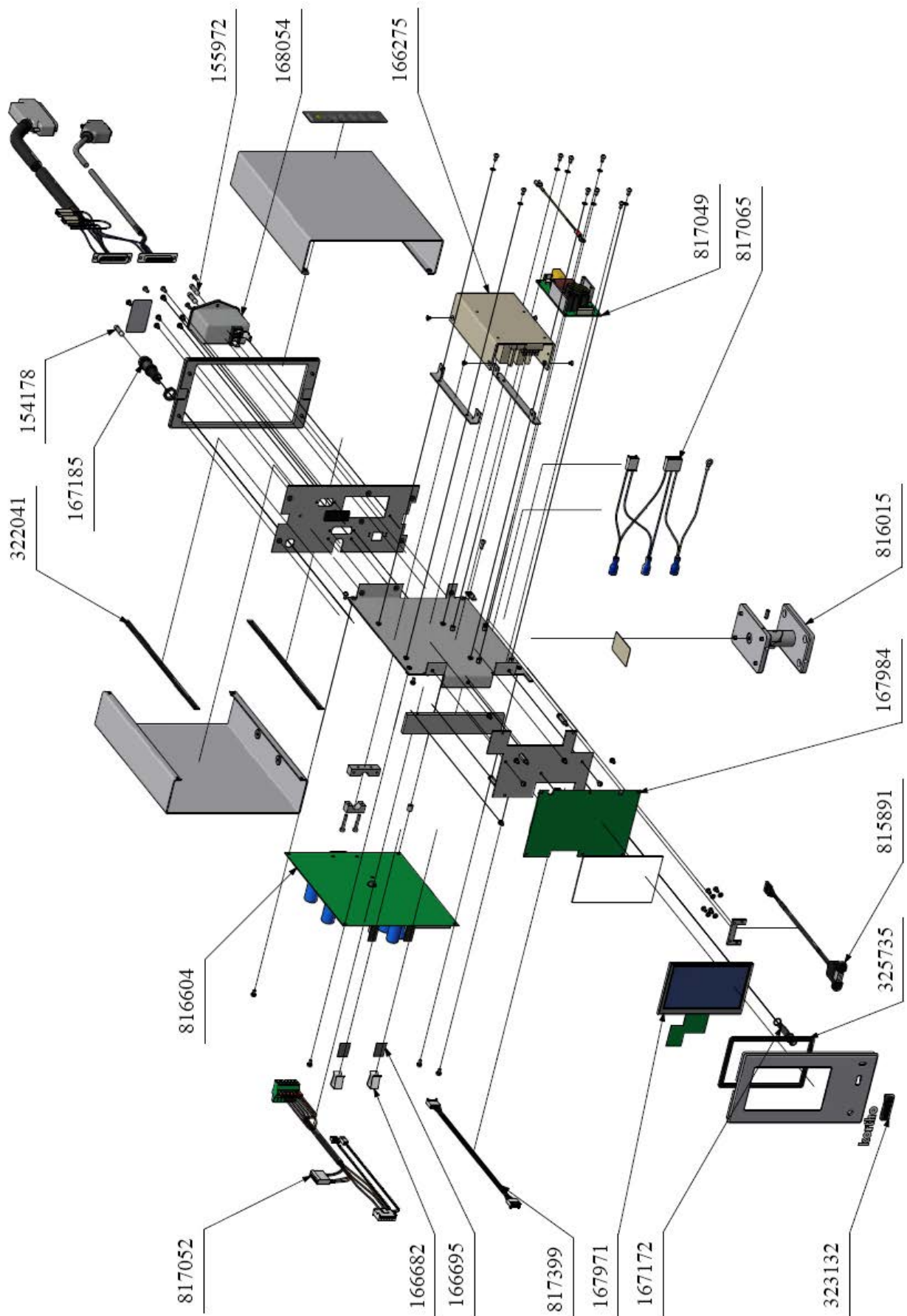

## Standard bracket L=520 and L=620

### Standard bracket L=520

-----			Bracket L=520		
Line	Part no.	Description	Line	Part no.	Description
1	324771	St.St. tube D=30, L=520 support QiC	6	817122	Set adjustment block support QiC
2	324768	St.St. shaft D=15, L=520 support QiC	7	817247	Roll complete L=520, QiC i/c
3	816645	Roll foil-adjustment L= 520 support QiC i/c	8	817262	Strip QiC support QiC
4	816884	Encoder ind. support QiC C	9	817304	Platen roller QiC c
5	817107	Set frontplate support QiC			

### Standard bracket L=620

-----			Bracket L=620		
Line	Part no.	Description	Line	Part no.	Description
1	324714	St.St. tube D=30, L=620 support QiC	6	817122	Set adjustment block support QiC
2	324812	St.St. shaft D=15, L=620 support QiC	7	817221	Platen roller QiC c
3	816661	Roll foil-adjustment L=620 support QiC i/c	8	817259	Roll complete L=620, QiC i/c
4	816884	Encoder ind. support QiC c	9	817262	Strip QiC support QiC
5	817107	Set frontplate support QiC			

# APPENDIX C, PART LISTS & ILLUSTRATIONS

Standard bracket L=520 and L=620

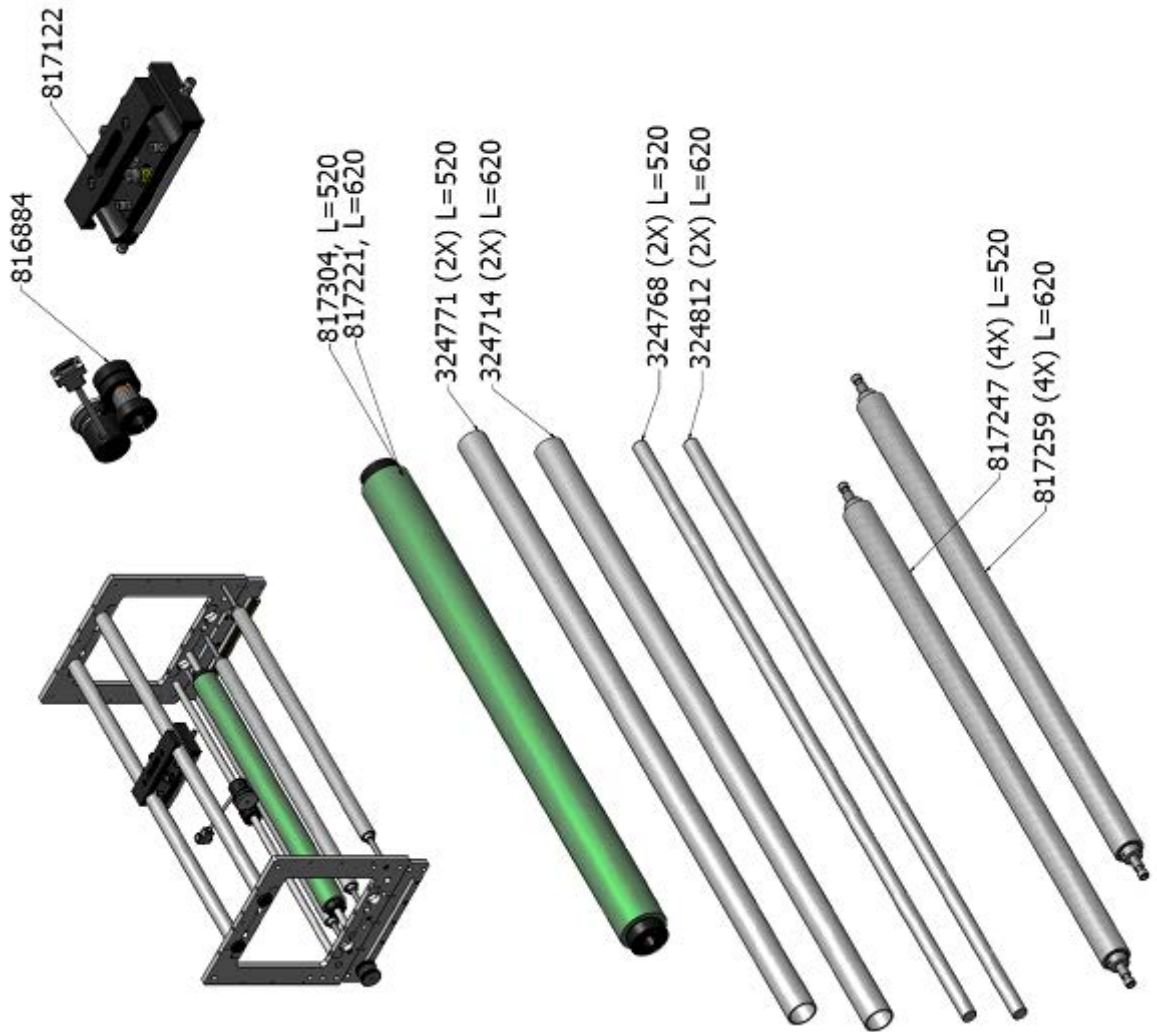





# Appendix D      Connections

---

Control unit Connector Plate..... D-2

X3 Schematic diagram (input) ..... D-3

X3 Schematic diagram (output) ..... D-4

X3 Circuit diagram (input) ..... D-5

X3 Circuit diagram (output)..... D-6

X3 Schematics diagram User..... D-7

Pneumatic circuit diagram ..... D-8

**Control unit Connector Plate**

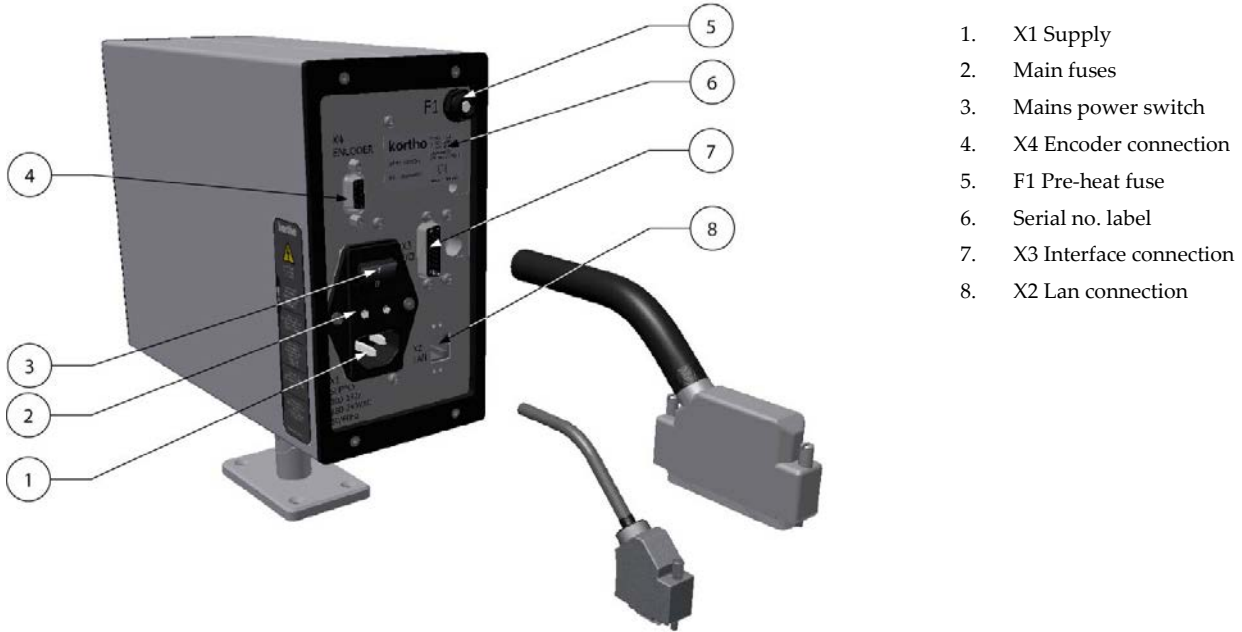

Item	Description	Connector type
X1	Mains Supply with switch and 2 fuses	3,15A (T)
X2	LAN connection	RJ45, socket
X3	Interface connection (input/output)	HD 26-ways, socket
X4	Encoder (not present at 30i printer)	
F1	Preheat fuse	500mA (F)
LABEL	Partnumber, serialnumber and mains supply specification	

# X3 Schematic diagram (input)

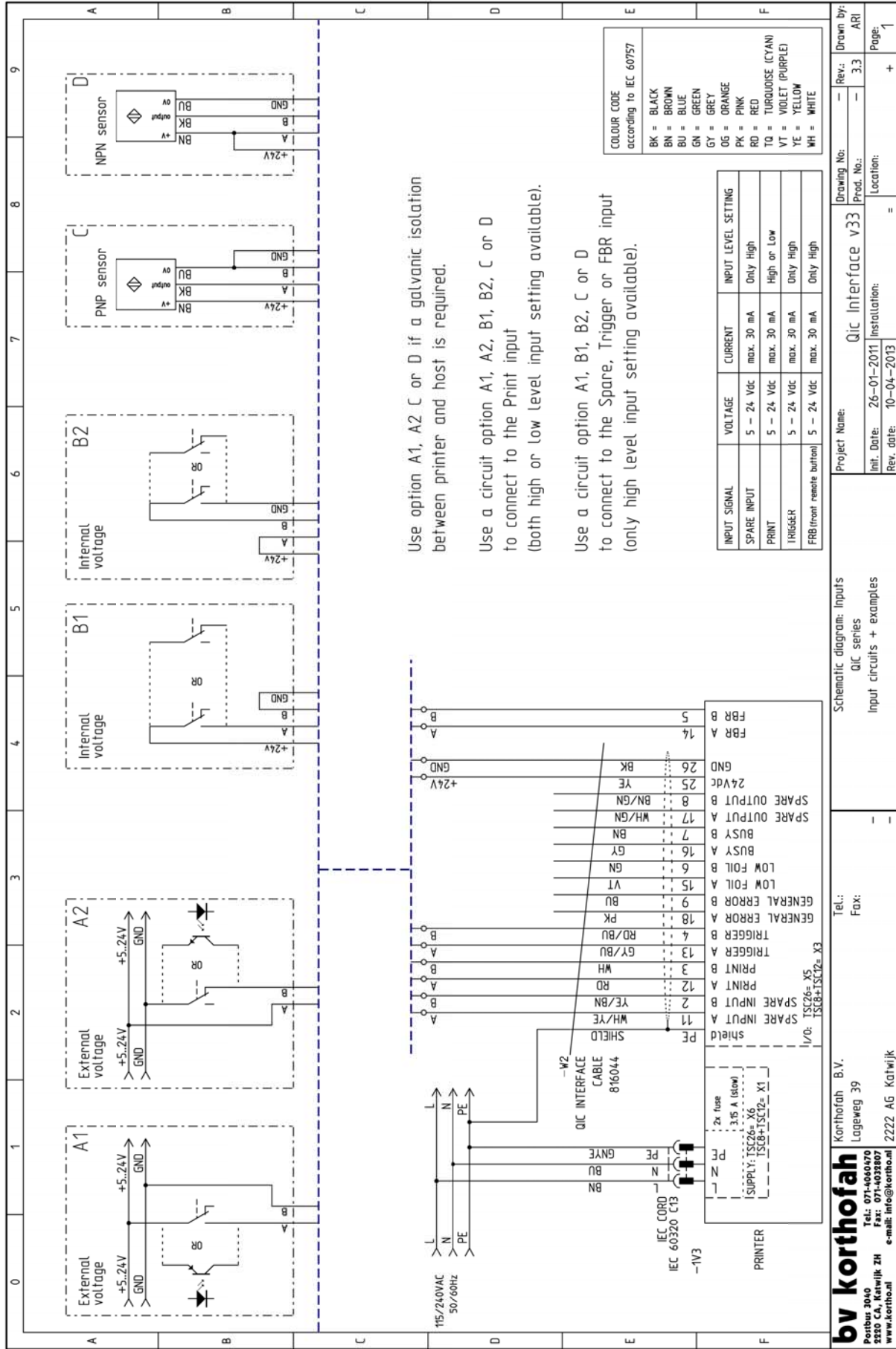

### X3 Schematic diagram (output)

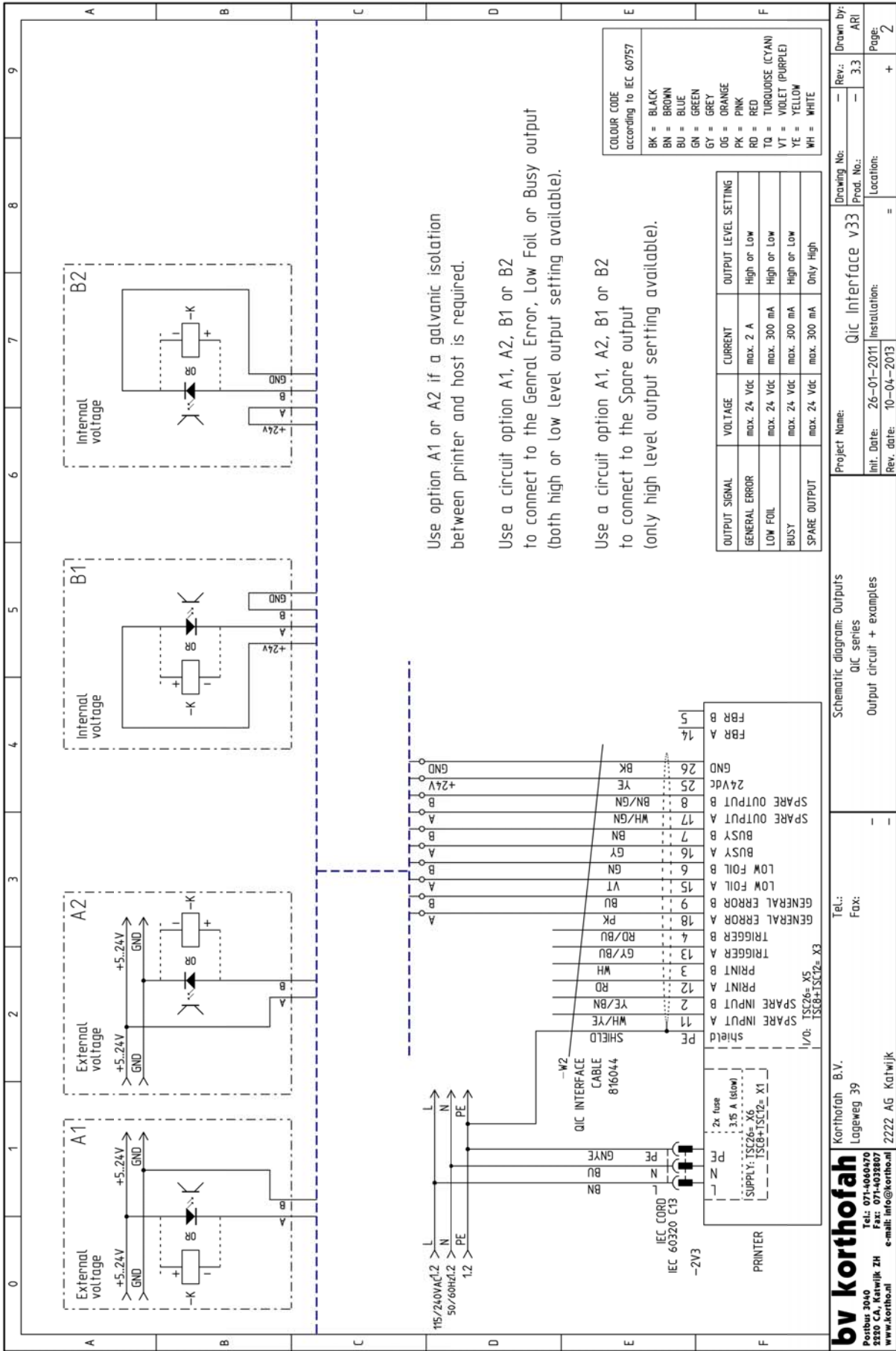

Use option A1 or A2 if a galvanic isolation between printer and host is required.

Use a circuit option A1, A2, B1 or B2 to connect to the General Error, Low Foil or Busy output (both high or low level output setting available).

Use a circuit option A1, A2, B1 or B2 to connect to the Spare output (only high level output setting available).

COLOUR CODE according to IEC 60757

BK	=	BLACK
BN	=	BROWN
BU	=	BLUE
GN	=	GREEN
GY	=	GREY
OG	=	ORANGE
PK	=	PINK
RD	=	RED
Ta	=	TURQUOISE (CYAN)
VT	=	VIOLET (PURPLE)
YE	=	YELLOW
WH	=	WHITE

OUTPUT SIGNAL	VOLTAGE	CURRENT	OUTPUT LEVEL SETTING
GENERAL ERROR	max. 24 Vdc	max. 2 A	High or Low
LOW FOIL	max. 24 Vdc	max. 300 mA	High or Low
BUSY	max. 24 Vdc	max. 300 mA	High or Low
SPARE OUTPUT	max. 24 Vdc	max. 300 mA	Only High

**Project Name:** QIC Interface v33  
**Project No.:** 26-01-2011  
**Location:** =

**Schematic diagram:** Outputs QIC series  
 Output circuit + examples

**Rev. No.:** 3.3  
**Rev. date:** 10-04-2013

**Drawn by:** ARI  
**Page:** 2

**bv korthofah**  
 Postbus 3040  
 3220 CA, Katwijk ZH  
 Tel.: 071-4060470  
 Fax: 071-4038807  
 e-mail: info@korthofah.nl  
 2222 AG Katwijk

**Korthofah B.V.**  
 Lageweg 39

### X3 Circuit diagram (input)

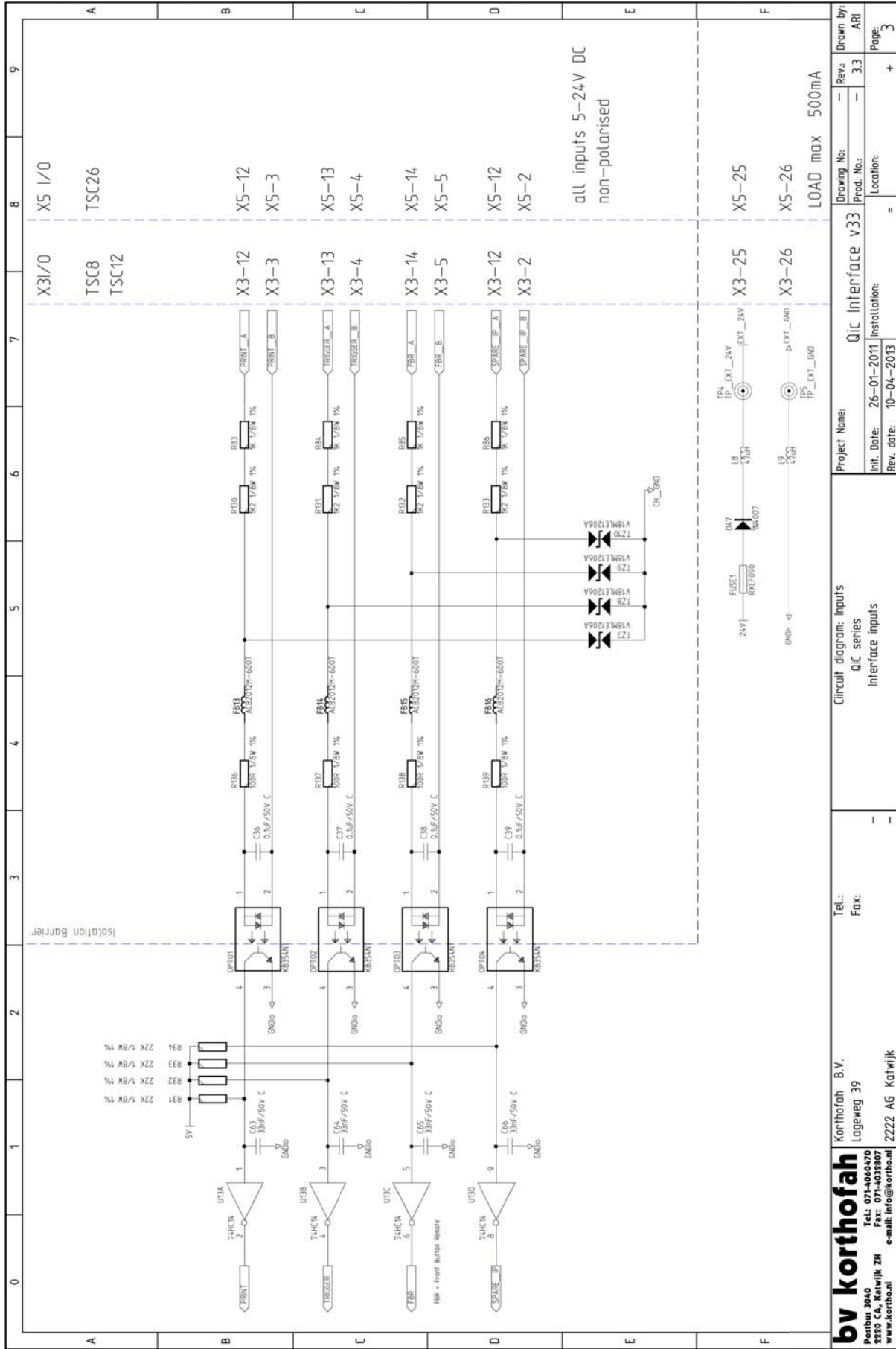

X3 Circuit diagram (output)

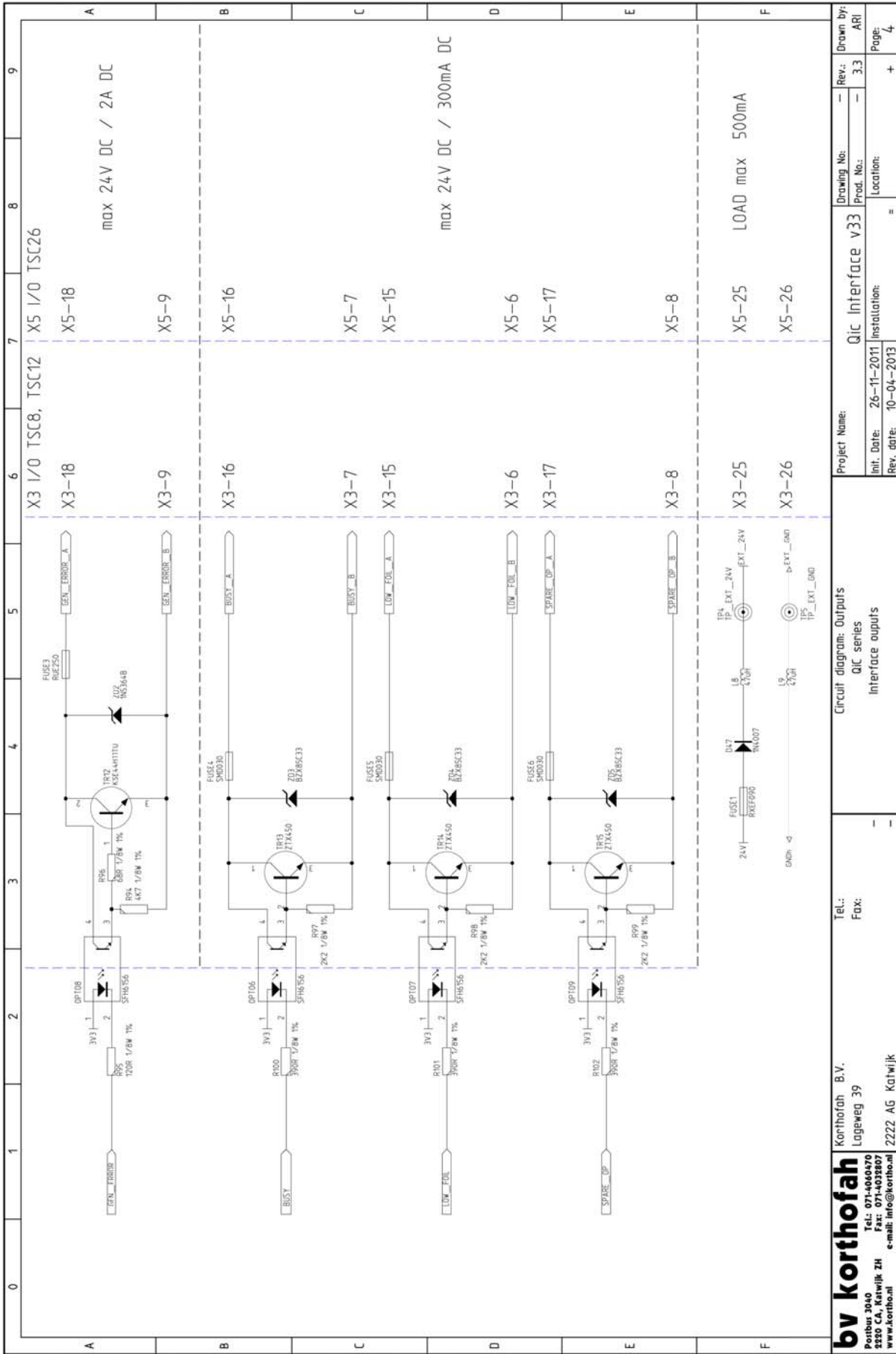

Project Name: Qic Interface v33		Drawing No: -	Rev.: -	Drawn by: ARI
Init. Date: 26-11-2011		Prod. No.:	Location:	Page: 4
Rev. date: 10-04-2013		Installation: =		
Circuit diagram: Outputs QIC series Interface outputs		Tel.: - Fax: -		
Korthofah B.V. Lageweg 39 Postbus 3040 5320 CA, Katwijk ZH www.kortho.nl		2222 AG Katwijk		

# X3 Schematics diagram User

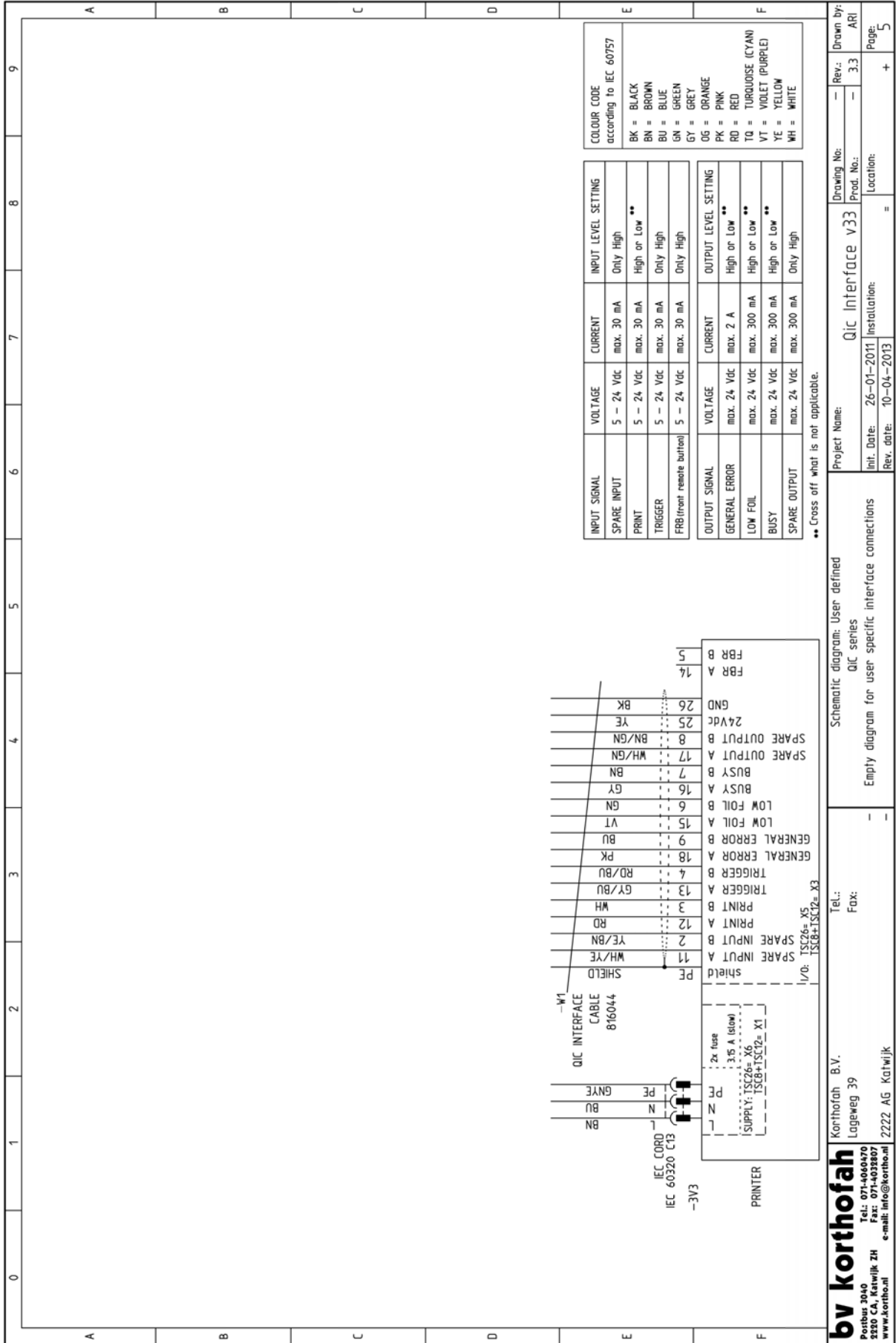

This diagram can be used to note the specific user settings.

### Pneumatic circuit diagram

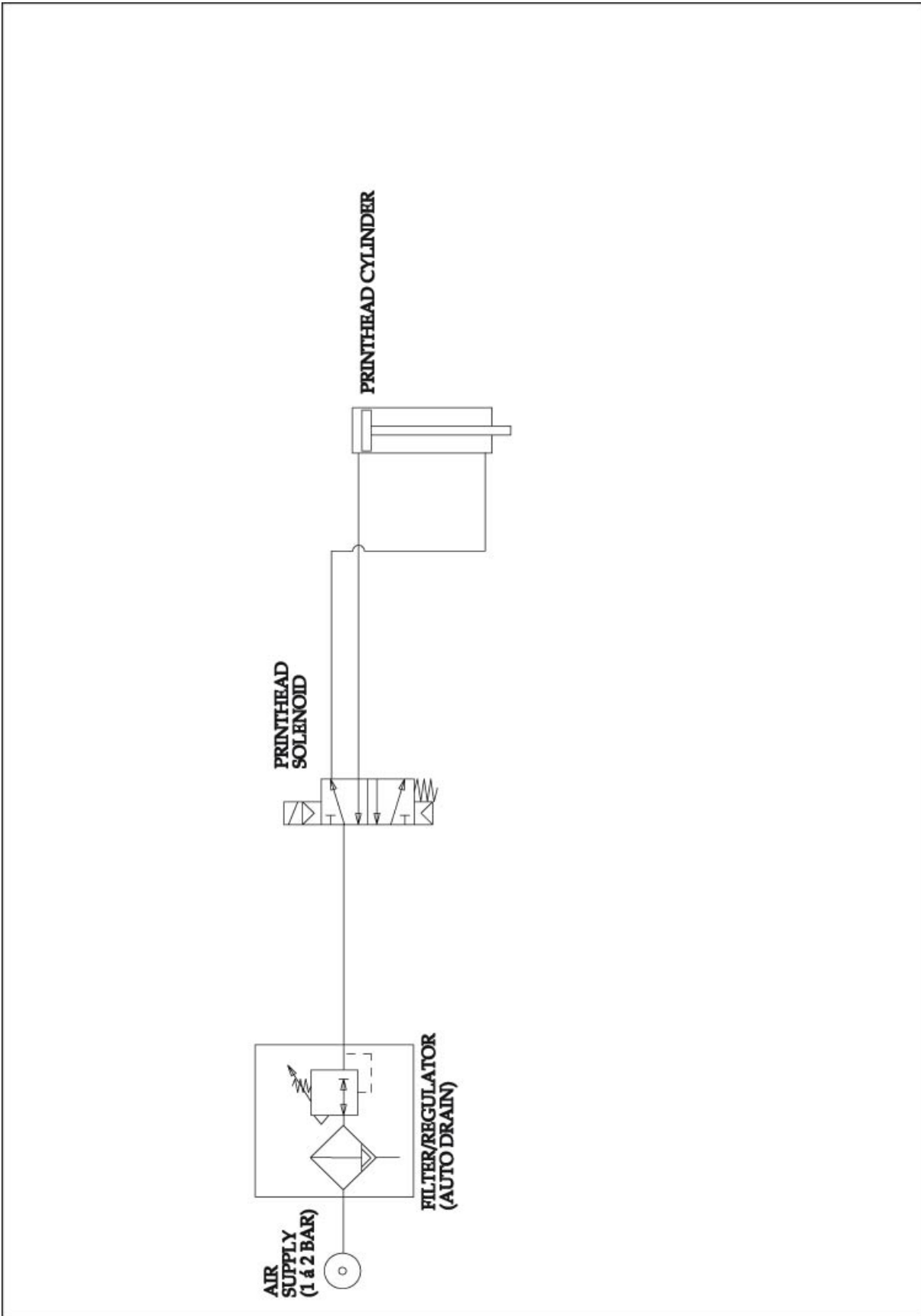



# Appendix E NiceLabel driver tutorials

---

- Installation and configuration of the driver ..... E-2
  - Function of the driver ..... E-2
  - Versions of the driver ..... E-2
  - Installation of the driver ..... E-3
  - Configuration of the driver ..... E-6
  - Summary ..... E-8
- Downloading a label through USB ..... E-9
  - Introduction ..... E-9
  - Installation of the driver ..... E-9
  - Download a label through USB ..... E-10
- Sending a label on a network ..... E-11
  - Introduction ..... E-11
  - Installation of the driver ..... E-11
  - Sending a label on a network ..... E-11

## Installation and configuration of the driver

This appendix is based on the general description for the installation and configuration of the driver. The procedures are based on the Kortho GraphicJet X18. It speaks for itself that if one like to perform the procedures for the QiC Thermal transfer printers, one should select the desired printer model instead of the Kortho GraphicJet X18.

### Function of the driver

The printer driver can be installed on a PC/laptop in order for a printer to receive and execute print commands from a PC/Laptop. Every printer has its own driver. In order to control 5 individual printers with 1 PC/Laptop, it is therefore required to have 5 individual drivers on that PC/Laptop. The driver for the Kortho printers (named Nicedriver) is Windows based. This means that the driver (and with that the Kortho printers) can be controlled by all common Windows systems. Most ERP systems are also capable of printing to a Windows driver. This means that one could control all Kortho printers in a production plant by using 1 central ERP system (SAP, Microsoft Dynamics NAV etc.).

For every printer under control, there is a driver installed on the PC/Laptop:

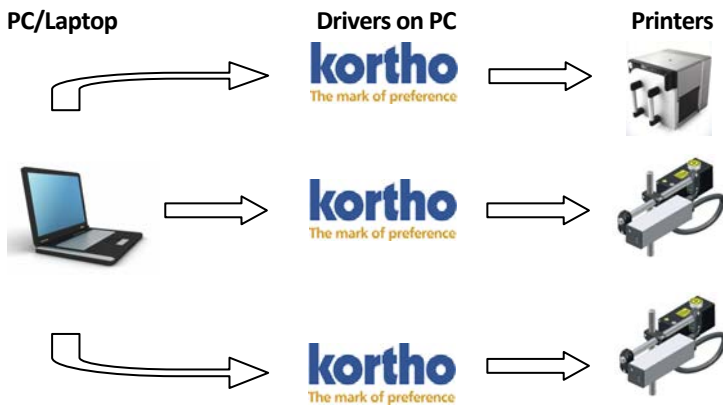

So if there are several lines and/or several printers that should receive print commands from 1 single PC/Laptop, there should be a driver installed for each printer. The driver translates every signal sent from the PC/Laptop separately, and translates these signals into a signal the printer can create an image out of.

### Versions of the driver

In order to have a driver communicate correctly with a printer, it is important for the driver's version to be compatible with the printer's firmware version. To be sure the right driver will be installed, the firmware should be checked first. To check the firmware version of the printer:

1. Touch the *Information* icon.
2. Touch the *System info* button.



After checking the firmware version the compatible driver can be downloaded from the Kortho website ([www.kortho.com](http://www.kortho.com)).

In general the following firmware-driver combinations are compatible:

- Driver version: 4.6.63 (Build 3230) and higher
- Minimal Printer Firmware version: V1.0-16032011

For firmware lower than this version, use driver version 4.6.44 or turn the two-way support off at the driver's port setting.

### Installation of the driver

As soon as the compatible driver has been downloaded, it can be installed on the PC/Laptop which is going to control the printer(s).



**Beware:**

If the label needs to be downloaded through a USB thumbdrive one should set the driver accordingly, see **Fout! Verwijzingsbron niet gevonden., Fout! Verwijzingsbron niet gevonden..** The description below is based on the situation in which the label is sent to the printer through the Ethernet.

To install the driver :

1. Unzip the downloaded file.
2. Start the installation by executing the program PrnInst.exe.
3. Click *Next*.

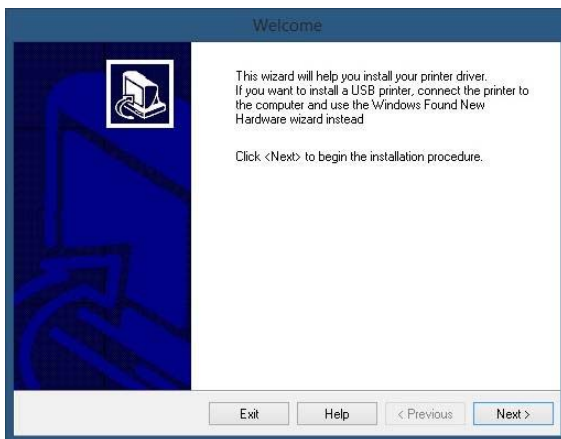

4. Accept the conditions and click *Next*.

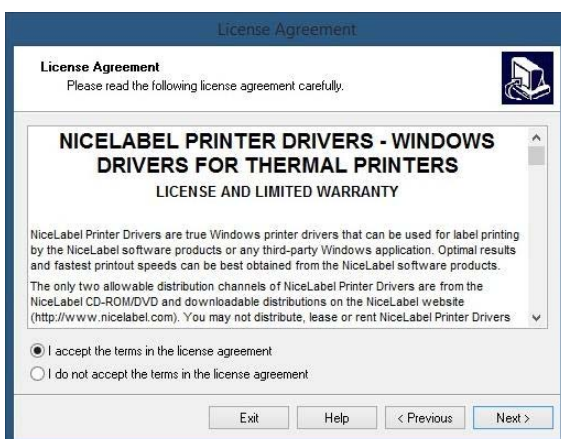

5. Select the desired printer and click *Next*.

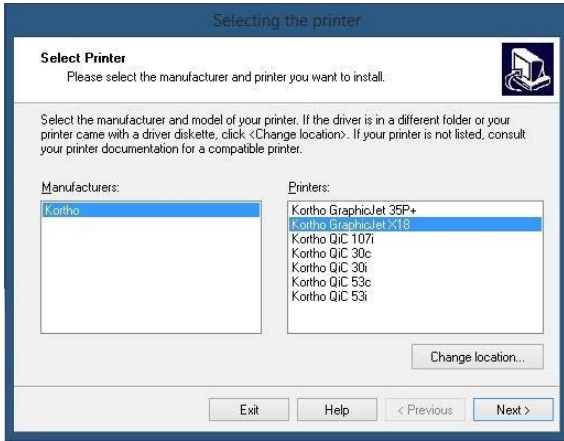

6. Click *Add Port*.

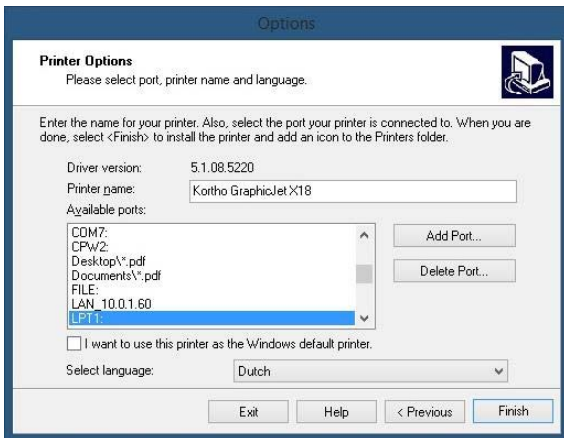

7. The Advance Port Monitor Configuration will appear. Execute the following steps:
- a. Enter printer’s IP address (Port name automatically changes with the IP address, for example IP: 192.168.1.10).
  - b. Optionally enter a Name for the port (So that the port is easily recognized, for example: X18\_line).
  - c. Enter the Port number (With a Korho printer this is always **14322**, this is the control unit’s fixed number).
  - d. Click OK (A printer port will be created).

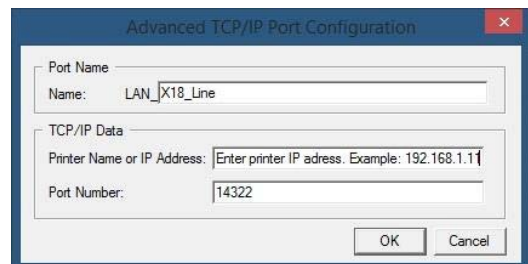
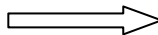
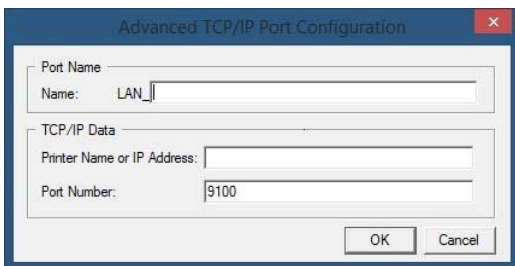

8. The printer is now selected automatically out of the list of available ports.
9. Optionally:
  - a. Give the printer a Printer name.
  - b. Select a language for the printer’s properties.
  - c. Select the printer as standard printer.

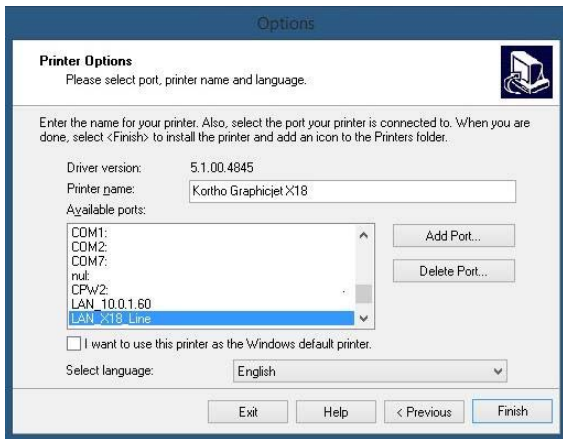

10. Click *Finish* to close the screen. A progress screen will appear installing the driver.

11. Open the printer configuration screen in Windows. This is found in Windows “Start” or in “Start > Configuration screen”. The printer is added as shown below:

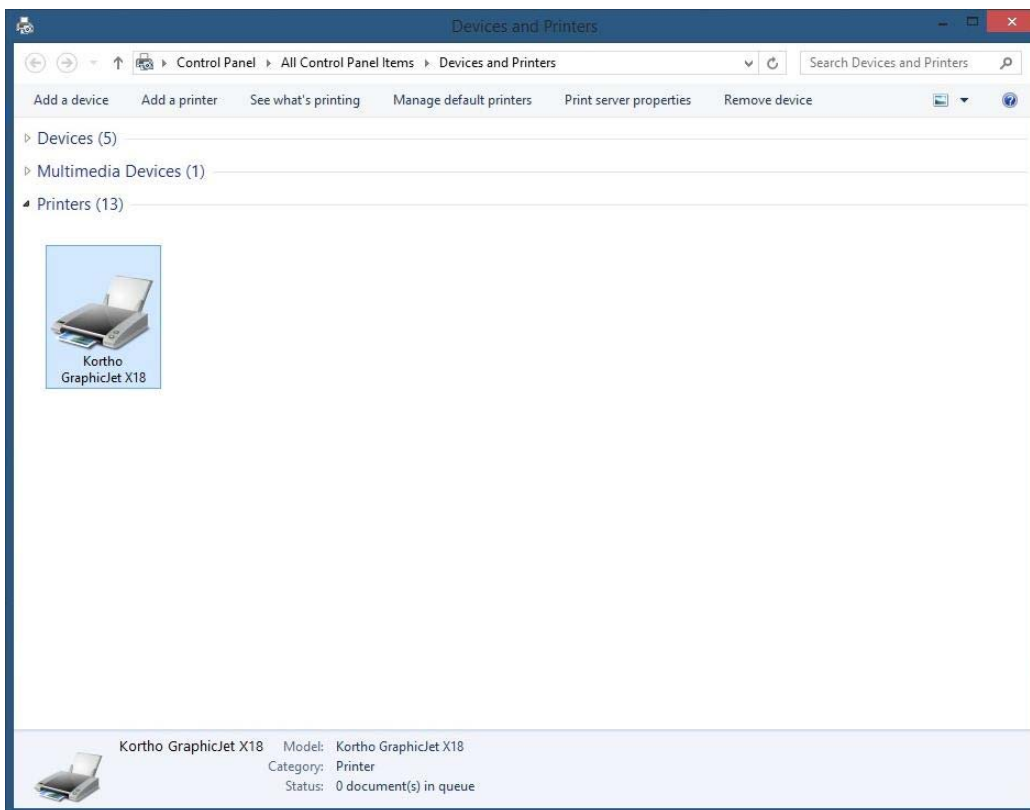

12. Right click on the printer and select *Printer properties*.

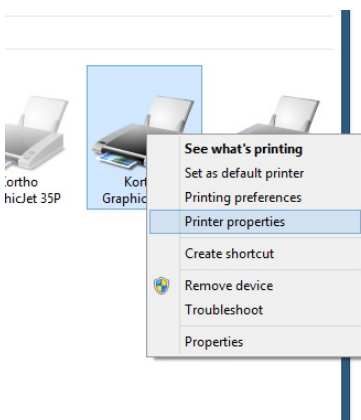

13. Select the tab *General*.

14. Click *Print Test Page* to test the installation. The printer will print het Windows logo.

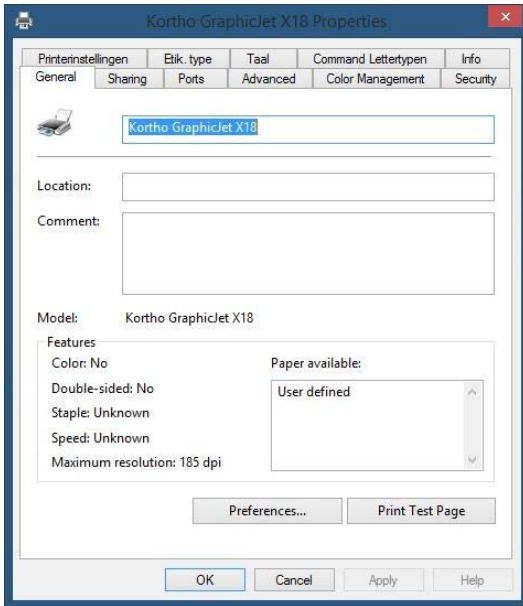

### Configuration of the driver

In order to more easily work with the printer and set up labels, a standard label type can be set.

1. Open the printer configuration screen in Windows. This is found in Windows "Start" or in "Start>Configuration screen".
2. Right click on the printer and select *Properties*.
3. Select the tab *Etik. Type*.

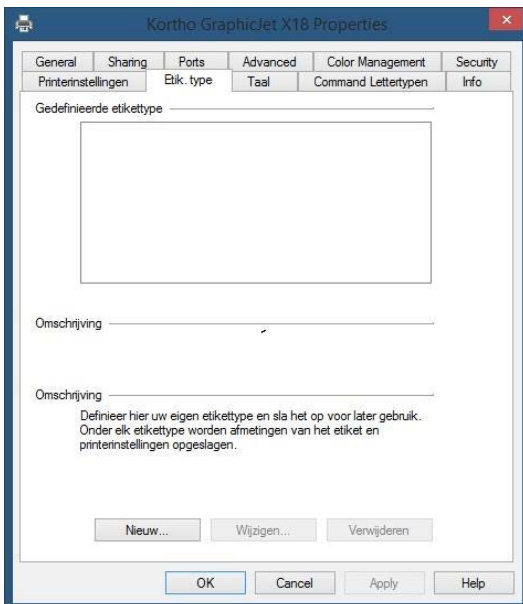

4. Click *New* (Nieuw).

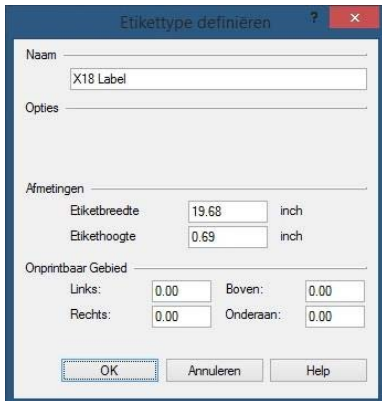

5. Enter the Label length and Label width (Labels can be defined, so that the label stays within certain dimensions. That is how label programs like Nicelabel take the printer's printable surface into account).
6. Enter a Name for the label.
7. The values for unprintable areas for the Kortho printers are already correctly set to 0,0.
8. Click *OK* to close the screen.
9. The label with the right dimensions of printable area (which will be taken into account by the printer) is now added to the list of labels for the printer "Kortho X18\_Line 1". When using several Kortho printers the standard label will have to be added separately for each printer.

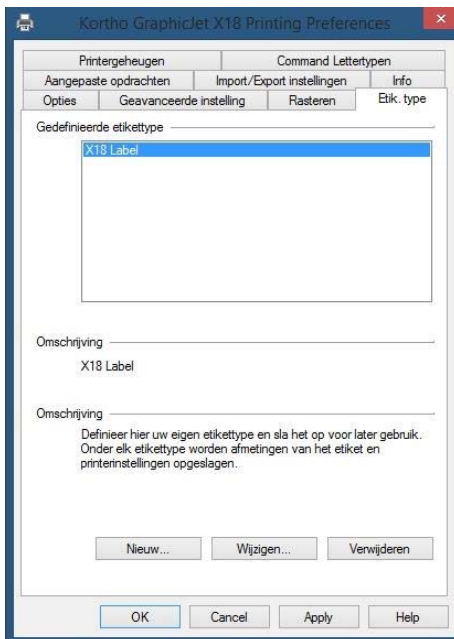

10. Click *New* (Nieuw) again to add another label definition or click *OK* to close the screen.

When designing a label in a designing program one can select the printer "Kortho X18\_Line 1" and after that "X18 Label" as a label/tag/paper size (name depends on the label design program). The program will take the printers parameters of the selected label/tag/paper size into consideration.

Because the Kortho driver was developed by Nicelabel, the driver can define Nicelabel's settings. Within Nicelabel, the only options available will be actions that the printer will actually support. Due to this, the margins for errors due to wrong configuration/settings is limited and it is beneficial to the user friendliness. To adjust these settings:

1. Open the printer configuration screen in Windows. This is found in Windows "Start" or in "Start > Configuration screen".
2. Right click on the printer and select *Printer properties*.

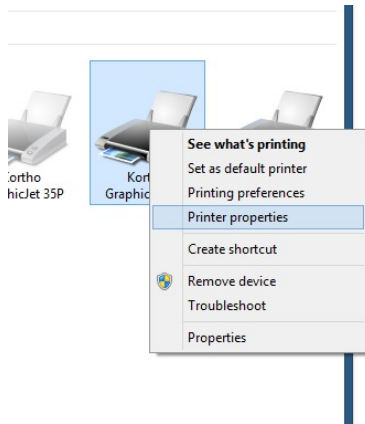

3. Select the tab *Advanced settings* (Geavanceerde instelling).
4. Check the box *Use printer settings* (Gebruik printer instellingen) to let the printer parameters manage the label programs settings. If this box is not checked, the driver will overwrite the printers settings the moment a print command is sent.
5. Click *OK* to close the screen.

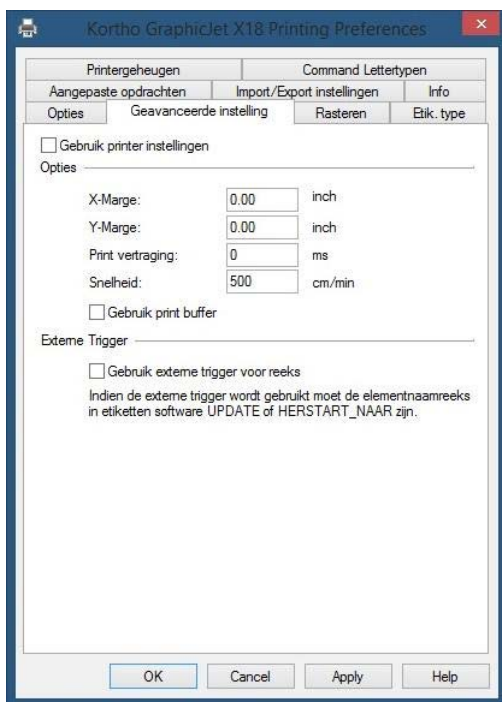

## Summary

The Kortho GraphicJet X18 can be installed on any Windows PC/Laptop in the same way a “normal” desktop printer is installed. After installation the printer can be chosen amongst the other (desktop) printers currently in use on the PC/Laptop.

After installation of the driver the printer’s print area can be defined. By doing this the driver can communicate the information back to a label desing program (like Nicelabel, Bartender etc.). When defining the lay-out of a label, the program will take the printer’s parameters into account. With a normal desktop printer for example the parameter for the printable area is A4. With a Kortho printer the printable area depends on the printer model.

Because the driver was developed by Nicelabel, it is not only automatically certified for use with all Windows systems/Labeldesign programmms. The advantage of using Nicelabel is that while defining the label’s lay-out, one can take the printer properties and setting into account. Due to this the settings (like print area, speed, contrast and method of data transfer) are automatically set correctly. So by using Nicelabel the system not only becomes more user friendly, but it also decrease the chance of errors due to incorrect settings.



## Downloading a label through USB

### Introduction

The labels can be designed with a PC based design tool or they can be designed on the control unit. The labels designed with a PC based design tool can be downloaded to the control unit by Ethernet or by USB thumbdrive. The labels will be stored in the print memory.



#### Beware:

Before a label be downloaded through a USB thumbdrive it needs to be printed to a Printfile (\*.prn). It is not possible to download the original label file to the printer.

### Installation of the driver

As soon as the compatible driver has been downloaded, it can be installed on the PC/Laptop which is going to control the printer(s).

To install the driver :

1. Unzip the downloaded file.
2. Start the installation by executing the program PrnInst.exe.
3. Click *Next* (Volgende).
4. Accept the conditions and click *Next*.
5. Select the desired printer and click *Next*.

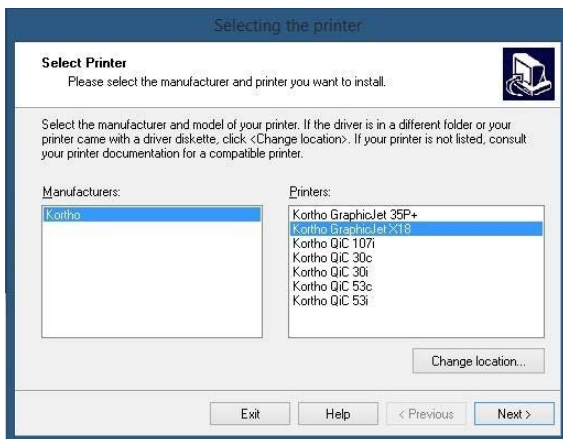

6. Select *FILE:*, change the printer name (optional) and click *Complete* (Voltoeien).

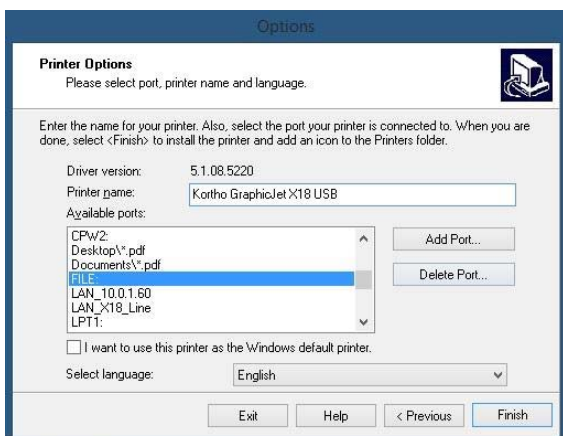

The driver is now installed on your PC/laptop and can be used to generate Printfiles.

## Download a label through USB

To download a label by a USB thumbdrive:

1. Start Nicelabel and design a new label (or open an existing one – continue with step 4).



**Beware:**

To guarantee a good print result it is important that the label is designed for the printer to which one would like to download the label.

2. Select the right printer (driver configured to print to File as described above) and click *Finish*.

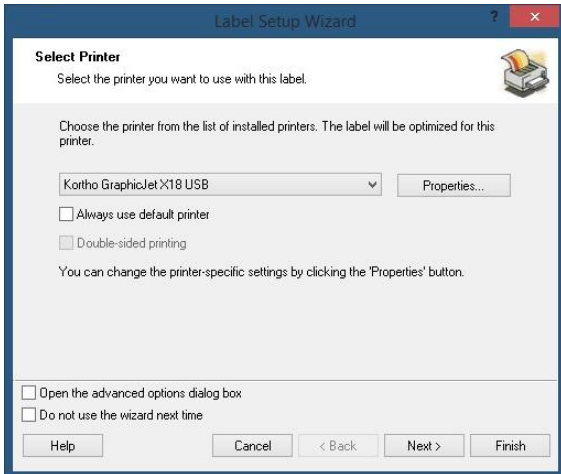

3. Save the new label design.
4. Insert a USB thumbdrive into the PC/laptop.
5. Select *File – Print* to print the label.

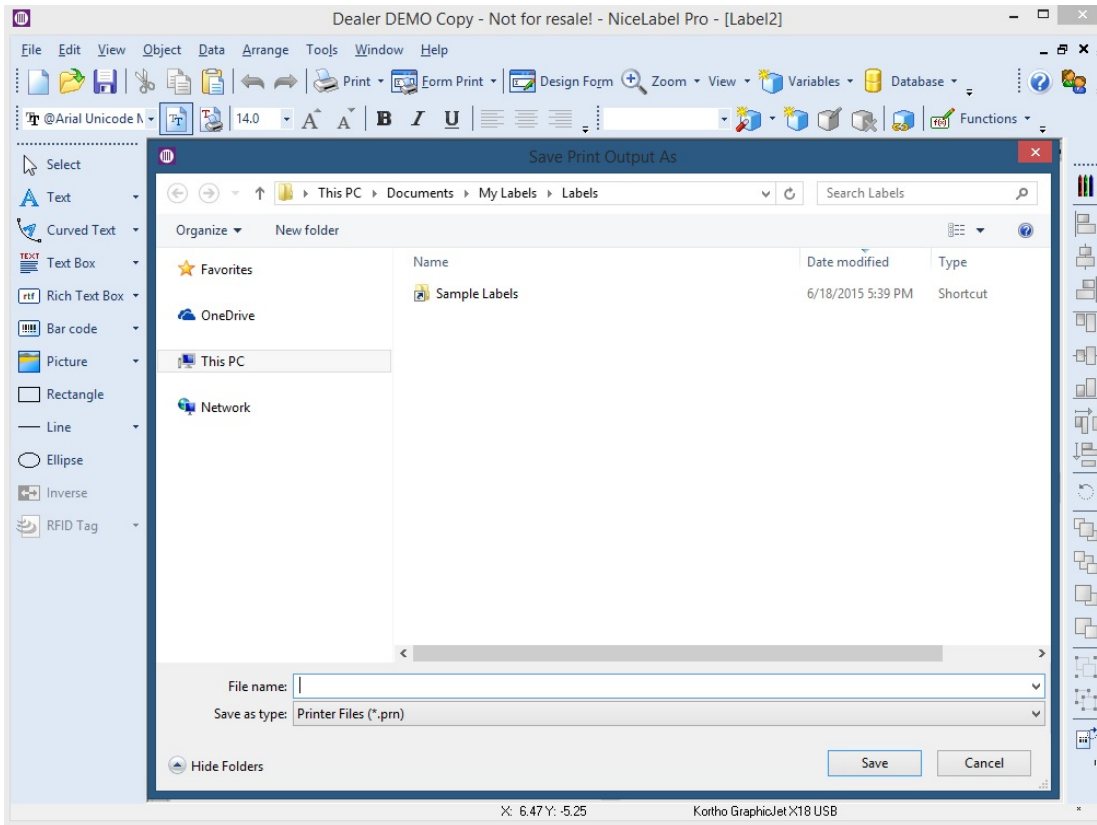

6. Choose the location of the USB thumbdrive to save the Printfile.

7. Give the Printfile a name including the extension prn, e.g. Testlabel.prn (preferably the same name as the Label name, in this way there is a clear relation between the Printfile (which can not be edited) and the Labelfile (which can be edited)).
8. Click Save to save the Printfile on the USB thumbdrive.
9. Dismount the USB thumbdrive, so it can be safely removed from the PC/laptop.
10. Remove the USB thumbdrive.
11. Insert the USB thumbdrive into the control unit and wait for 4 seconds so it can be detected and mounted.
12. Copy the printfile on to the control unit by following the procedure as described in chapter 8.4.2.
13. Select the printfile for printing by following the procedure as described in chapter **Fout! Verwijzingsbron niet gevonden..**

## Sending a label on a network

### Introduction

The labels can be designed with a PC based design tool or they can be designed on the control unit. The labels designed with a PC based design tool can be downloaded to the control unit by Ethernet or by USB thumbdrive. The labels from a thumbdrive will be stored in the print memory, while the label sent directly from the driver will be temporarily selected and cannot be reselected manually from the controller.

### Installation of the driver

Install the driver as described in **Fout! Verwijzingsbron niet gevonden., l.**

### Sending a label on a network

To download a label through Ethernet:

1. Start Nicelabel and design a new label (or open an existing one – continue with step 4).
2. Select the right printer (driver configured to Port as described above) and click *Complete* (Voltooien).

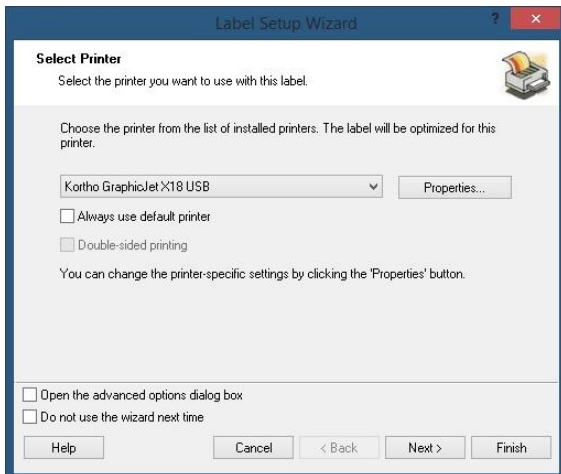

3. Save the new label design.
4. Select *File – Print* to print the label.



#### **Beware:**

To guarantee a good print result it is important that the label is designed for the printer to which one would like to download the label.

5. Select the amount of prints that need to be made.

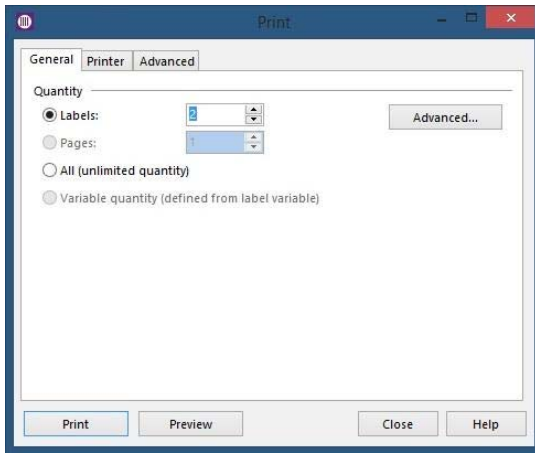

6. Select *Print* and the printer will start printing the selected label.

# Appendix F Quick reference

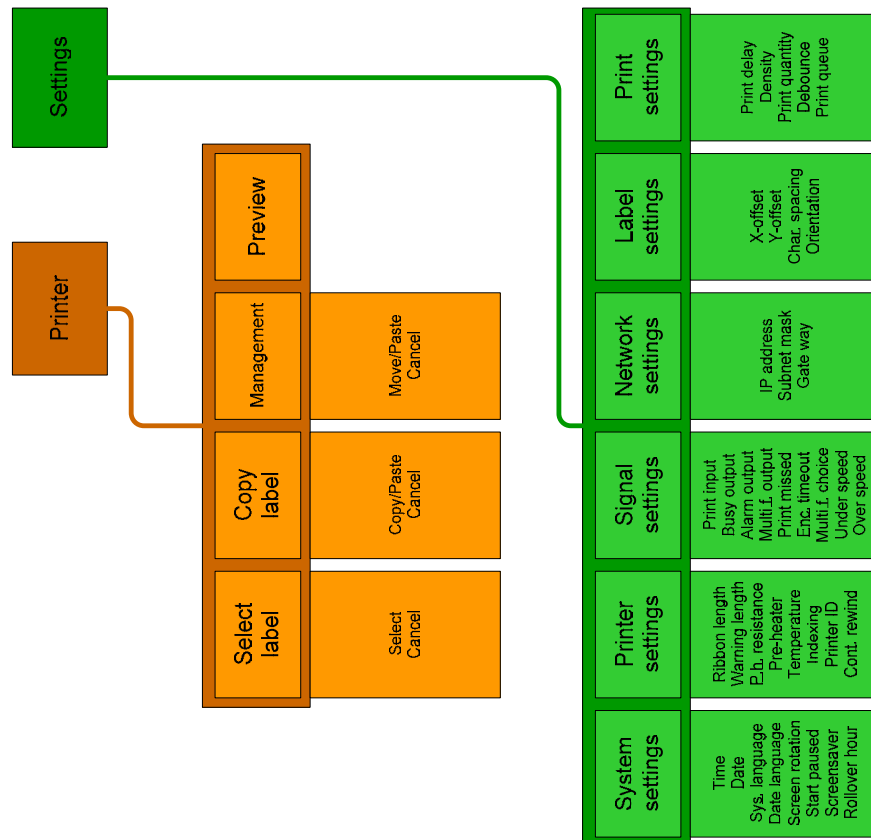
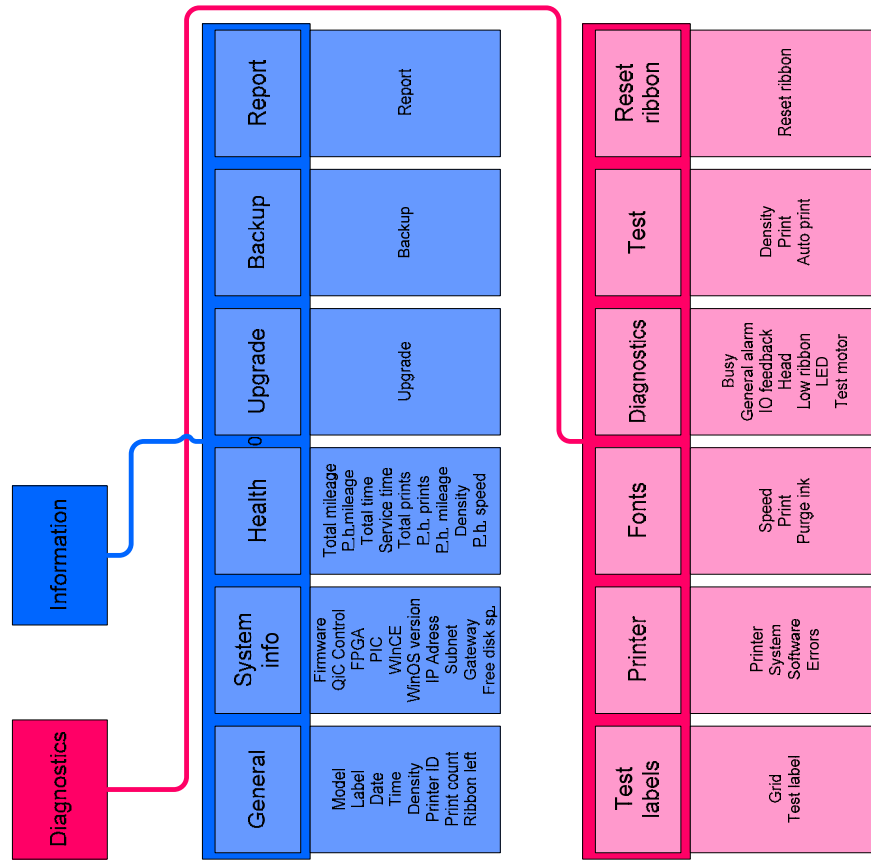



## Appendix G Error list

---

The following errors / warnings can be generated by the system:

- Error 00 Initialising Ethernet
- Error 01 An error occurred while loading fonts.
- Error 02 There are too many autocodes in the label.
- Error 03 PIC not responding.
- Error 04 A font in the label is not installed. Please install the font.
- Error 05 The software has a problem with addressing the EEPROM. Try again or upgrade the software.
- Error 06 There is not enough memory space available for the font.
- Error 07 The maximum storage space for a label is 96Kb. Reduce the file size.
- Error 08 The printer received an incomplete message. Try again.
- Error 09 The CRC check of the message is incorrect.
- Error 10 Security token old. Login again.
- Error 11 There is a problem with the Flash memory.
- Error 12 There is a problem with the ribbon encoder.
- Error 13 Unknown command received. Check the command or upgrade the firmware.
- Error 14 Minimum value is
- Error 15 Maximum value is
- Error 16 Missing value.
- Error 17 Maximum digits for
- Error 18 Maximum characters for
- Error 19 Date invalid.
- Error 20 Time invalid.
- Error 21 Wrong name or missing variable.
- Error 23 Maximum users
- Error 24 Access Denied.
- Error 25 An unknown error occurred. Turn the printer off and back on after 10 seconds.
- Error 26 A problem occurred while generating the label. Try again.
- Error 27 Wrong coding unit connected. Connect the appropriate coding unit.
- Error 28 Font Error.
- Error 29 There is a problem with the font. Check Windows whether the font is correct.
- Error 30 The printhead carriage does not return to home position.
- Error 31 There is a problem with the ribbon transport.
- Error 32 A timeout occurred for the print position.
- Error 33 A print is missed. The print request signal was received while printing.
- Error 34 The label is too small or the font is missing. The label must be at least 3 mm in size.
- Error 35 A timeout occurred for the print-encoder.
- Error 36 The ribbon encoder is connected incorrectly. Swap the wires.
- Error 37 The carriage encoder is connected incorrectly. Swap the wires.
- Error 38 First user must be manager.
- Error 39 User list empty.
- Error 40 Security disabled.
- Error 41 Print magazine missing or placed incorrect.

## APPENDIX G, ERROR LIST

---

Error 42	Wrong FPGA. The software is incompatible with this model type. Load the appropriate software.
Error 43	Wire too tight.
Error 44	The printer is paused. Start the print process to continue.
Error 45	The coding unit type is unknown. Check the coding unit and connections.
Error 47	There is no coding unit detected. Connect a coding unit or check the connections.
Error 48	The total size of the multi-label is too large. Reduce the label size.
Error 49	Maximum number of labels reached. Remove a label before adding a new one.
Error 52	The printer is almost out of ribbon.
Error 53	Printhead carriage encoder error. Check the air pressure and the mounting of the encoder.
Error 54	There is no label loaded to print. Load a label.
Error 55	Use internal encoder for testprints.
Error 59	The PX2 board is not calibrated. Calibrate the PX2 board.
Error 60	Preview too large.
Error 61	The speed of the line is too low. The speed must be at least 40 mm/s (2,4 m/min).
Error 62	The speed of the line is too high. The speed can be up to 550 mm/s (33 m/min).
Error 63	Printhead temperature.
Error 65	Print missed.
Error 66	Printhead encoder timeout.
Error 67	Under minimum speed.
Error 68	Over maximum speed.
Error 69	IP address invalid.
Error 70	Use command when paused.
Error 71	Wrong PX2 OS version.
Error 72	Some text is outside of the label area. Use label anyway?
Error 73	A graphic is outside of the label area. Use label anyway?
Error 74	An error occurred during booting. The label was removed.
Error 75	Print ramp timeout
Error 76	Loading variable backup
Error 77	Loading ontime backup
Error 78	Loading voltage backup
Error 79	Loading model backup
Error 80	Backup EEPROM failed
Error 81	Counters Reset
Error 82	Label made for another printer type.
Error 83	Total length of label including Y-offset is too long. Y-offset reset to 0.
Error 84	Printer stopped. Print quantity has been reached.





**bv korthofah**

P.O. box: 3040  
2222 AG, Katwijk  
The Netherlands

---