kortho

MANUAL

QiC i-series Thermal Transfer Printer



bv korthofah

P.O. box: 3040
2220 CA, Katwijk
The Netherlands

Tel: +31 71 40 60 480
Fax: +31 71 40 32 807
E-mail: export@kortho.nl
Internet: www.kortho.com, www.kortho.eu

In light of continuous development and improvement, Korthofah BV reserves the right to modify the specifications without prior notice. The figures printed in this manual may slightly differ from the Kortho QiC i-series thermaltransfer printers. Information in this document is subject to change without notice.

No part of this document may be reproduced or transmitted in any form or by any means, electronic or mechanical, without the written permission of Korthofah BV.

Document date: 24/06/2016
Manual: H325 AE QiC 30i-53i-107i EN 005
Number of pages: 184

The basis for this manual is:

Series: QiC i-series
Production year: 2016
Original language: English

Standard models: QiC 30i/53i/107i + TsC12
QiC Control version: V1.0-23102013A

Copyright © 2016 **bv korthofah**
All Rights Reserved



QiC, QiC Draw, the **kortho** logo and the **bv Korthofah** logo are trademarks of Korthofah BV. All other brand and product names in this manual are the trademarks or registered trademarks of their respective holders.

Printed in the EC 2016

■ Preface

Welcome to the QiC i-series manual.

Read the manual before you start and read it carefully. This will avoid unnecessary problems and loss of performance.

This manual is meant for all personnel who are involved with the QiC i-series, which includes the QiC 30i, the QiC 53i and the QiC 107i. The purpose of this manual is to get familiar with the QiC i-series. This involves operational, safety, transport & storage, installation, commissioning, fault diagnosis and maintenance instructions.

The general construction of the different type of coding units of the QiC i-series is the same. Because of this there is no need to show pictures of each individual model. All pictures shown in this manual are of the QiC 30i.

All personnel must read the first four sections named INTRODUCTION, TECHNICAL DESCRIPTION, PRINT PROCESS DESCRIPTION and SAFETY. The other sections provide instructions or information for different aspects of the QiC i-series.

Keep this manual on a sensible and safe place for future use.

Contact Korthofah BV or your local distributor if you have any questions.

Conventions in this manual:

- The printers of the QiC i-series will be referred to as the printer.
- Any material that is used to print on is called substrate.
- The customer is the person or company who is the owner of the printer.
- Follow the instruction order as indicated when you carry out any of the procedures described.

Instruction format:

1. Instruction. Comment(s).
 - a. Sub-instruction. Comment(s).
 - b. Sub-instruction. Comment(s).
2. Instruction. Comment(s).

■ Symbols in this manual

In this manual, the following symbols are used:



WARNING:

This symbol indicates a potentially hazardous situation which, if instructions are not followed, could result in death or serious injury.



CAUTION:

This symbol indicates a potentially hazardous situation which, if instructions are not followed, may result in minor or moderate injury or damage to property.

The statements above are notes for your safety.



Beware:

A notice with useful information for the user in relation to the product. It attends the user to possible problems.



Note:

Gives the user suggestions and helps the work to be carried more rapidly.

■ Glossary

Bitmap:	A data file or structure. A set of bits that represents a graphic image, with each bit or group of bits corresponding to a pixel in the image.
Host:	A machine or production system that handles the product or substrate and can be connected by an interface to the printer, e.g. a printer alarm to stop the machine.
Index:	Distance between two printed areas on the used ribbon, also known as 'ribbon gap'.
Label:	A design file from which the printer generates the bitmap to print. This design file can contain a unique combination of text, numeric, date, time, barcode and/or graphical items.
Label memory:	Memory on the MMI board in which the labels can be stored. From this memory labels can be selected for printing (stored in the print memory).
Pixel:	A pixel is the smallest portion of a bitmap. For a printer one pixel represents one dot (= one sequence of heating up of a single heating element of the print head).
Print:	The result of printing a label on a substrate.
Print memory:	Memory on the main board (PX2) in which the label to be printed is stored. Only one label can be printed at the same time, so only one label can be stored in this memory.
Print request:	A signal generated by a sensor or host machine. It is a trigger to start a print cycle.
Print cycle:	The moment from which the printer accepts a print request until the printer is ready to accept a new print request.
Product:	In this manual, the substrate the printer prints on, e.g. a packaging foil.
QiC Draw:	A design tool on a PC to create and edit labels. It also contains a service module which can be used during service/problem solving.
Ribbon:	Thermal transfer ribbon, pigment carrier foil.
Sensor:	A product detection device connected to the control unit.
Substrate:	This is the material to print on, e.g. packaging foil.

■ Table of contents

▪	Preface.....	iii
▪	Symbols in this manual.....	iii
▪	Glossary.....	iv
▪	Table of contents	v

1 INTRODUCTION

1.1	Qualified personnel.....	1-1
1.2	Elementary personal protection.....	1-1
1.3	Intended Use	1-1
1.4	Specifications.....	1-2
1.4.1	Coding unit	1-2
1.4.2	Control unit.....	1-2
1.4.3	Ribbon	1-3
1.4.4	Label features.....	1-4
1.4.5	Life span.....	1-5
1.4.6	Electrostatic charge.....	1-5
1.4.7	Shock & vibration	1-5

2 TECHNICAL DESCRIPTION

2.1	The printer system	2-1
2.2	Coding unit.....	2-2
2.3	Control unit.....	2-4
2.4	Air supply	2-4
2.5	Label design	2-5
2.5.1	QiC Draw label design software.....	2-5
2.5.2	NiceLabel	2-6

3 PRINT PROCESS DESCRIPTION

3.1	Print cycle	3-1
3.2	Printhead.....	3-1
3.3	Coding unit.....	3-2
3.4	User interface	3-2
3.4.1	Menu structure	3-3
3.4.2	LED indicators on control unit	3-4
3.4.3	LED indicators and front button on coding unit	3-4
3.4.4	Keyboard	3-5
3.4.5	System information.....	3-9
3.4.6	Menu structure	3-9

4 SAFETY

4.1	General	4-1
4.1.1	Warning messages.....	4-1
4.1.2	Caution messages.....	4-1
4.1.3	Beware messages.....	4-2
4.1.4	Notes	4-3
4.2	Control unit.....	4-4
4.2.1	General information.....	4-4
4.2.2	Power supply.....	4-4
4.2.3	Precautions before power-up	4-5

4.2.4	Precautions when opening the control unit	4-5
4.3	Anti-static precautions.....	4-6
4.3.1	Printhead	4-6
4.3.2	Printed circuit boards	4-6
5	TRANSPORT & STORAGE	
5.1	Printer equipment.....	5-1
5.1.1	Shipping and handling	5-1
5.1.2	Pre-transport procedure	5-1
5.1.3	Pre-storage procedure.....	5-2
5.2	Ribbon.....	5-2
5.2.1	Handling and storage	5-2
5.2.2	Transport information	5-3
6	INSTALLATION	
6.1	Requirements.....	6-1
6.1.1	Provided by the customer:.....	6-1
6.1.2	Equipment.....	6-1
6.2	Unpacking	6-1
6.2.1	Coding unit.....	6-1
6.2.2	Control unit TsC12.....	6-2
6.3	Mounting the coding unit.....	6-3
6.3.1	Coding unit mounting support.....	6-3
6.3.2	Substrate adjustment.....	6-3
6.3.3	Air supply	6-4
6.4	Mounting the control unit.....	6-4
7	COMMISSIONING	
7.1	Initial setup	7-1
7.1.1	Load the ribbon on the magazine	7-1
7.1.2	Aligning the printhead to the platen	7-2
7.2	Preparing the control unit.....	7-3
7.3	Optimising the print quality.....	7-3
7.4	User settings	7-5
8	OPERATION	
8.1	Powering up	8-1
8.2	Operational.....	8-2
8.2.1	Start printing	8-2
8.3	Operator data input	8-2
8.3.1	Text item input menu	8-3
8.3.2	Date advance input menu.....	8-4
8.3.3	Number start value input menu	8-5
8.4	Label management	8-6
8.4.1	Selecting a label for printing	8-6
8.4.2	Transferring labels to the control unit	8-6
8.4.3	Moving a label.....	8-9
8.4.4	Deleting a label	8-10
8.4.5	Showing a preview	8-11
8.5	Magazine handling.....	8-12
8.5.1	Removing the magazine	8-12
8.5.2	Placing the magazine	8-12
8.5.3	(Re)placing ribbon	8-13

8.6	Adjusting printer settings	8-13
8.6.1	System settings	8-14
8.6.2	Printer settings	8-20
8.6.3	Signal settings	8-21
8.6.4	Network settings	8-23
8.6.5	Label settings	8-25
8.6.6	Print settings	8-27

9 DIAGNOSTICS / TROUBLESHOOTING

9.1	Diagnostics	9-1
9.1.1	Test labels	9-1
9.1.2	Printer	9-3
9.1.3	Fonts	9-6
9.1.4	Diagnostics	9-6
9.1.5	Test	9-8
9.1.6	Reset Ribbon	9-9
9.2	Information	9-10
9.2.1	General	9-10
9.2.2	System Info	9-11
9.2.3	Health	9-12
9.2.4	Upgrade	9-12
9.2.5	Backup	9-14
9.2.6	Report	9-16
9.3	Screen calibration	9-18
9.4	Fault finding	9-19
9.4.1	Control unit	9-19
9.4.2	Coding unit	9-20
9.4.3	Print request signal sensor	9-22
9.5	Error/warning messages	9-22
9.6	Poor print quality	9-23

10 MAINTENANCE

10.1	Daily maintenance	10-1
10.1.1	Printhead	10-1
10.1.2	Platen	10-2
10.2	Maintenance after replacing the ribbon roll	10-2
10.3	Weekly maintenance	10-3
10.4	Half yearly and yearly maintenance	10-3
10.5	Printhead replacement	10-3
10.5.1	Printhead safety notes	10-3
10.5.2	Printhead replacement	10-4
10.6	Updating firmware and software	10-5

11 DISMANTLING & DISPOSAL

11.1	Dismantling	11-1
11.1.1	System	11-1
11.1.2	Coding unit	11-1
11.1.3	Control unit	11-1
11.1.4	Sensor devices	11-1
11.1.5	Ribbon	11-1
11.2	Disposal	11-2
11.2.1	Disposal method	11-2
11.2.2	Waste separation	11-2

Index

- Keywords I
- Figures III

Appendices

Appendix A	Specifications.....	A-1
Appendix B	Dimensions.....	B-1
Appendix C	Part lists & illustrations	C-1
Appendix D	Connections.....	D-1
Appendix E	NiceLabel driver tutorials	E-1
Appendix F	Quick reference	F-1
Appendix G	Error list	G-1
Appendix H	EC Declaration of conformity.....	H-1

1 INTRODUCTION

1.1 Qualified personnel

Operators are qualified when they have read and understand sections 1 to 8 of this manual. A specific preliminary training is not required.

Technicians that carry out repairs and technical maintenance on the printer equipment should have secondary technical education or comparable technical level of knowledge through practical experience.

Installation or servicing of the printer must only be performed by qualified personnel of Korthofah BV or a local distributor, which is designated by Korthofah BV.

For customer installations authorisation must be obtained from Korthofah BV or a local distributor, which is designated by Korthofah BV.

1.2 Elementary personal protection

- When installing or servicing the equipment ensure that the host machine is stopped.
- When installing or servicing the equipment ensure the control unit of the printer is switched off.

Please read the SAFETY section for more information

1.3 Intended Use

The QiC i-series Thermal Transfer Printers are industrial printers and are designed to print directly on substrates e.g. packaging foils. The printer can print labels with fixed and/or dynamic items. Dynamic items are items like operator input text, number, date and time. Beside text related items, the printer can also print items such as barcodes, shift-codes and graphics.

The labels will be designed with a PC based design tool and downloaded by the user. The labels can be downloaded to the control unit by Ethernet or by USB thumbdrive. Ethernet can be used to download a label to the print memory. By using the USB thumbdrive many labels can be copied to the label memory. While selecting a label for printing the label will be transferred from the label memory to the print memory. The print memory can only hold one label.

Normal use means use under normal conditions as described in this manual i.e. use ribbons recommended by Korthofah BV and use only original spare parts.

The printer may not be used in areas which have a fire or explosion hazard.

Korthofah BV does not accept any liability for damage to the equipment or personal injury resulting from improper use of the equipment or improper maintenance. Neither does Korthofah BV accept any liability for the normal wear-and-tear of the equipment.

1.4 Specifications

Only general specifications are described in this section. Refer to Appendix A for more detailed specifications.

1.4.1 Coding unit

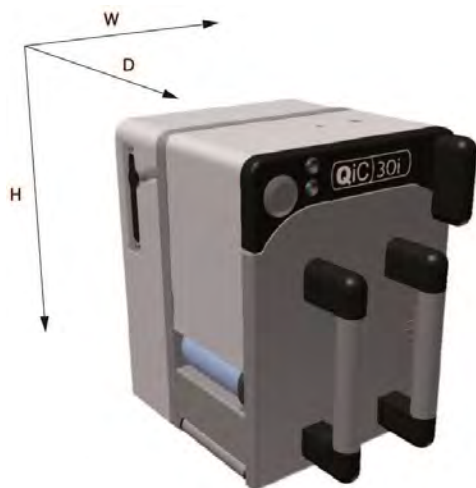

Fig. 1.1 Coding units, global dimensions

A general impression of the coding unit dimensions is given in Fig. 1.1. The dimensions (H x W x D) of the coding units are (bracket excluded, see section 6.3.1 and 6.3.2):

Part.nr.	Printer	Height	Width	Depth	Print area
816629	Coding unit QiC 30i	196	166	192	53x30
816311	Coding unit QiC 53i	196	214	192	53x107
815722	Coding unit QiC 107i	196	214	244	107x107

The ambient temperature must be between 5 °C and 40 °C, with a relative humidity between 10% and 90% (non-condensing).

Use only Kortho thermal transfer ribbon for this printer.

1.4.2 Control unit

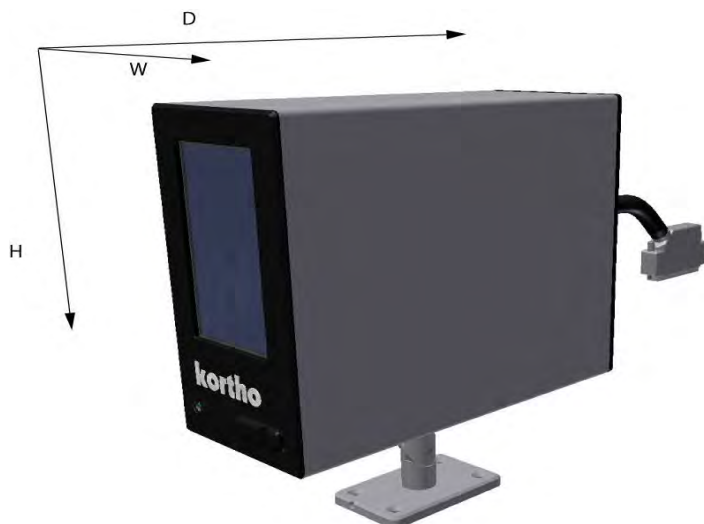

Fig. 1.2 Control unit, global dimensions

INTRODUCTION

A general impression of the control unit TsC12 dimensions is given in Fig. 1.2. The dimensions (H x W x D) of the control unit TsC12 are 186mm x 98mm x 239mm.

As the different printer type require different settings there is a control unit available for each type of coding unit.

Part.nr.	Description
817332	Control unit TsC12, QiC 30i
818242	Control unit TsC12, QiC 53i
818255	Control unit TsC12, QiC 107i

The electrical requirements for the power supply of the 30i and 53i printers are:

- Voltage rating: 100-120 / 200-240 Vac;
- Frequency rating: 50 and 60Hz;
- Current rating: 1,55A / 0,75A
- Power rating: 150VAm_{ax}.
- Fuse rating: 2x T3,15A 250Vac (slow acting).

The electrical requirements for the power supply of the 107i printers are:

- Voltage rating: 100-120 / 200-240 Vac;
- Frequency rating: 50 and 60Hz;
- Current rating: 2A / 1A
- Power rating: 200VAm_{ax}.
- Fuse rating: 2x T3,15A 250Vac (slow acting).

All external equipment that is connected to the control unit interface must be double insulated to qualify the whole installation as a separated extra-low voltage (SELV, Class II) system.



CAUTION:

Make sure the interface cable is no longer than 30m. Using a cable longer than 30m can cause EMC interference.

The control unit has a bespoke hardware user interface, communication ports and host I/O-ports.

The ambient temperature must be between 5 °C and 40 °C, with a relative humidity between 10% and 90% (non-condensing).

1.4.3 Ribbon

The ribbon supplied by Korthofah BV is specifically selected for the QiC i-series thermal transfer printers. It guarantees an optimum print head protection and so print head life time in combination with an optimum print result. In order to guarantee an optimum print result on each packaging material Korthofah BV supplies a wide range of different ribbon types. In addition, ribbons are available in a variety of colours.

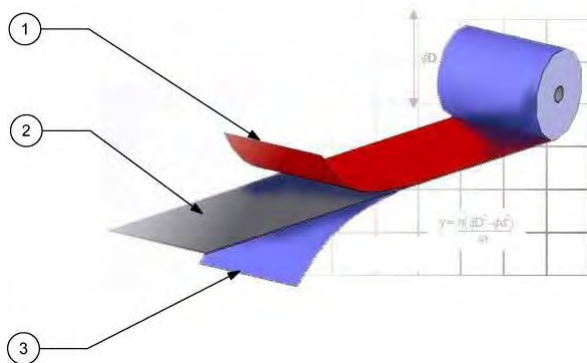

1. Back coating
2. Carrier film
3. Ink/pigment

Fig. 1.3 Ribbon

Ribbon is composed of three layers: Back coating, Carrier film and Ink.

The back coating contains extremely small beads of silicon which protect the sensitive printhead from abrasion, provides excellent heat conductivity to enable the ink to transfer to the substrate and reduces the formation of static electricity, which is harmful to the printer and its operator. Cheaper ribbons without this protection layer can damage the printhead.

The polyester film carrier provides the mechanical stability ensuring the ribbon doesn't break under the stresses of acceleration yet allows the heat developed by the thermal printhead to be transferred into the ink.

The ink formulation balances wax and resins to produce the optimum print quality based upon printhead technology, the substrate being printed, print speed and environmental conditions (e.g. ambient temperature and humidity).

The thermal ribbon should be stored in a dark, dry and cool place.

The recommended ambient temperature while printing is between 10 °C and 30 °C.

1.4.4 Label features

Label:

- Name: User defined name.
- Test label: A label that is permanently available (cannot be deleted) and specifically designed for making test prints to check the print quality and the correct setting of several parameters.
- Items: Text, multiple line text, number, date, time, shiftcode, barcode, line and box items and graphic. These items are placed in a label with the label design software.
- Data: Fixed and variable.
- Size: Maximal 96kB.
- Max. items: 7 number items per label. 1000 external or 400 internal characters per text item (including check characters).

Font:

- Internal: 6 fonts are preinstalled on the system; Liberation Sans, Liberation Serif, Tahoma, Century Gothic, Arial black and ArabDigit Black. In addition extra fonts can be stored. The system offers full downloadable font support for Windows TrueType fonts. The font ArabDigit Black can only be used for Arabic digits, e.g. time, date and numbers. The other internal fonts can be used to print fixed and variable text e.g. time, date and operator input text, see section 9.1.3.
- External: fonts used in a label but not installed on the system. External fonts will be treated as fixed data/text. So if an external font is used in e.g. a time item, the system will start printing the time at which the label has been loaded in the print memory, but will not update it during the print process. I.e. the system will print the same time during the complete production batch.

Barcode formats: Several barcode formats are available among which Codabar, Code 2 of 5, Code128, Data Matrix, EAN128, EAN13, EAN8, RSS-14, UPC A. For a complete list see section Appendix A. Barcodes will be printed as fixed items.

Items:

- Graphic: In jpg, jpeg or bmp format (black/white).
- Dynamic: Number, date, time and shiftcode.
- Operator input: Text, number, date.

Label download: Through Ethernet or a USB thumbdrive. Ethernet can be used to download a label to the print memory. By using the USB thumbdrive a lot of labels can be copied to the

label memory. While selecting a label for printing the label will be transferred from the label memory to the print memory. The print memory can only hold one label.

Storage capacity: 55MB (approximately 570 labels of the maximum label size).

1.4.5 Life span

The life span of the equipment is five years, except for the printhead, under normal use and in compliance with the indicated maintenance periods.

The life span can be negatively influenced by improper/uninformed use of the equipment or improper maintenance, repair or modification by unqualified personnel, or repair with non-original parts. No claims for guarantee or compensation for damages will be accepted in such instances.

1.4.6 Electrostatic charge

Make sure that the substrate is not able to build up an electrostatic charge near the printhead, i.e. use conductive rolls and bearings for substrate guidance, place an ESD brush or an ionizing air bar just before the printer.

An electrostatic charge will disturb the print by electrostatic influence on the printhead, this may cause permanent printhead failure.

1.4.7 Shock & vibration

The printer should be installed on a low vibration location.

It is recommended that the coding unit is protected from shock and vibration, as this will have severe impact on the printed label quality and printhead life.

2 TECHNICAL DESCRIPTION

This section is meant for all users. It describes all the main parts of the printer system.

2.1 The printer system

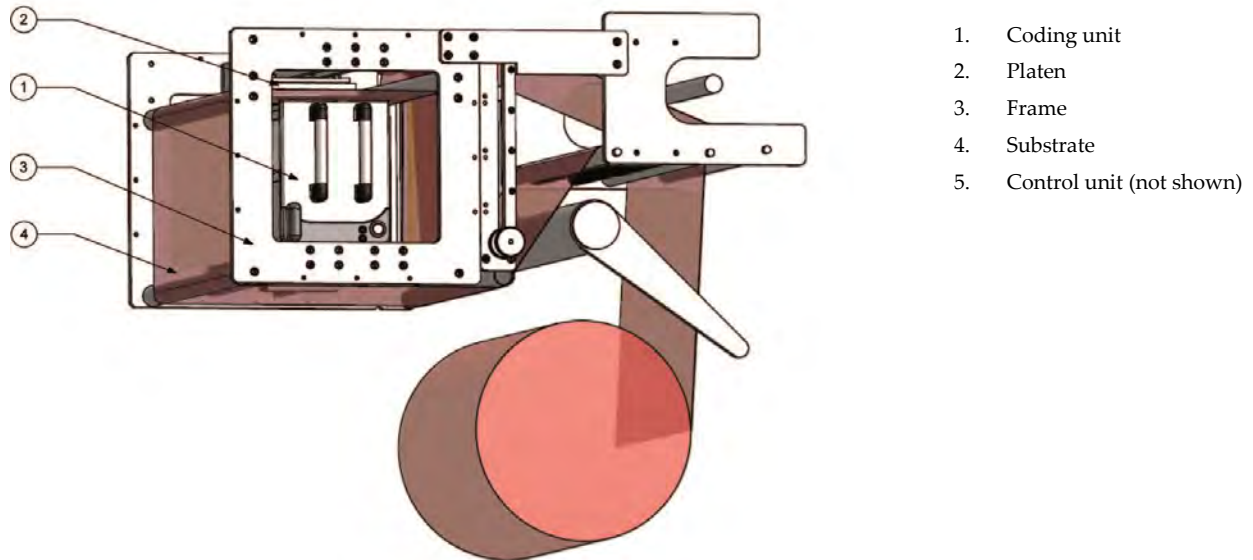

Fig. 2.1 The printer system

A typical thermal transfer system is shown in Fig. 2.1. The substrate is placed on an intermittent packaging machine and passes between the coding unit and the platen. As the substrate stops moving, the printer receives a print-request signal from the host machine or print sensor and the selected label will be printed on the substrate.

The thermal printhead receives the label line by line from the buffer memory and prints it on the substrate. The resolution is always 12 dots/mm (300 DPI) in width and, when the substrate is not moving while printing, 12 dots/mm (300 DPI) in length.

While the printhead returns to his home position the label variables will be updated.

After printing a label the printer is in stand-by mode again and awaiting the next print request signal.

After receiving the next print request signal the time and date items will be updated after which the system will print the completely updated label.

The coding unit is connected to the control unit. All connections between printer and peripheral devices are made on the control unit i.e. print request signal, alarm signals and Ethernet connection.

2.2 Coding unit



1. Printer body
2. Magazine

Fig. 2.2 Coding unit, parts

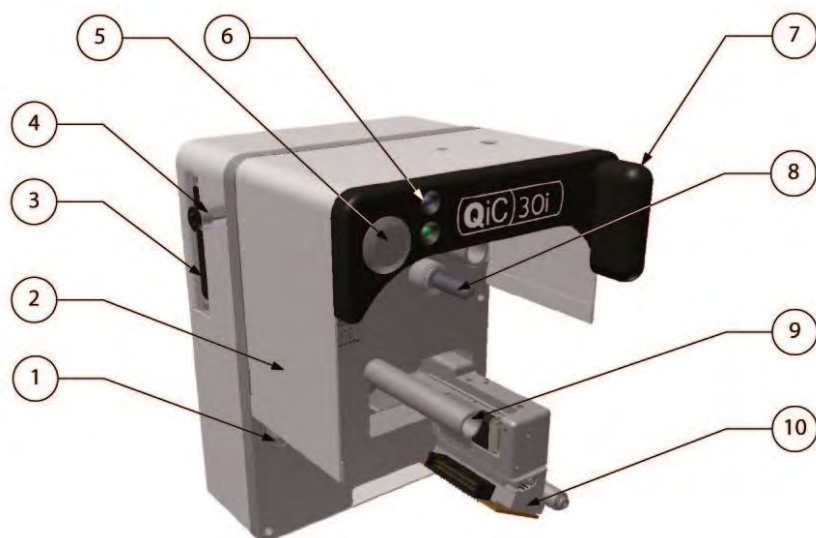

1. Ribbon movement sensor
2. Finger guard
3. Connection to control unit
4. Connection to air supply
5. Front button (S)
6. Status LED
7. Magazine handle
8. Magazine ribbon drive
9. Magazine guide
10. Printhead

Fig. 2.3 Coding unit, interior parts front

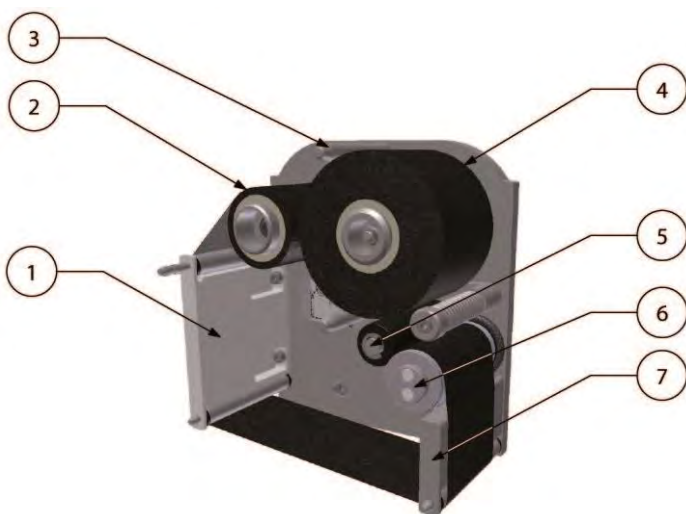

1. Finger guard
2. Used ribbon
3. Guide post
4. New roll of ribbon
5. Pressure roller
6. Ribbon sensor roller
7. Finger guard

Fig. 2.4 Magazine, parts

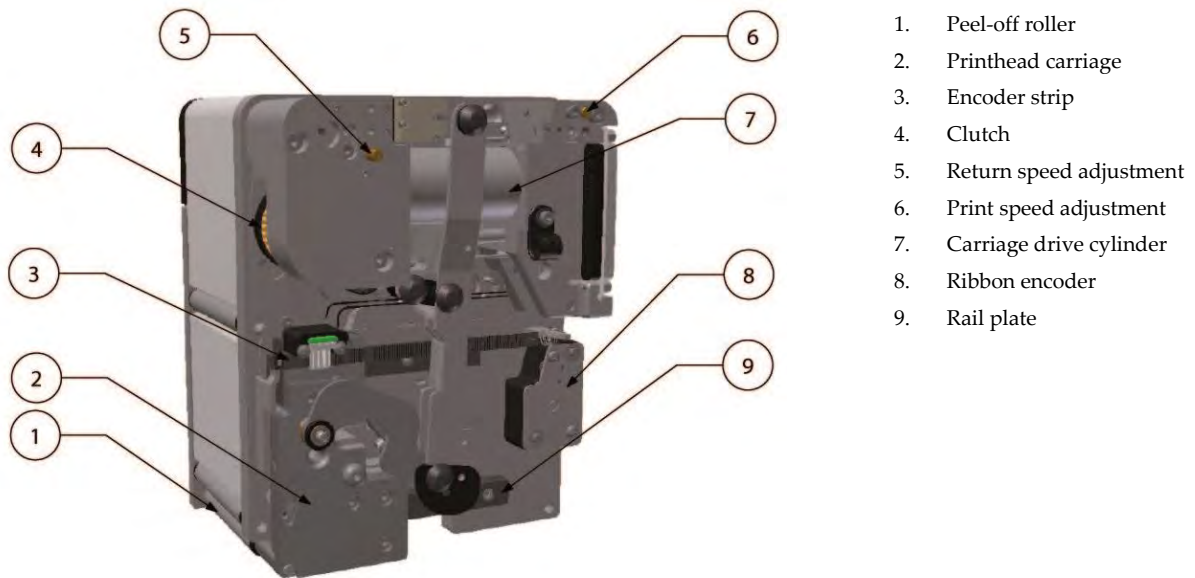

Fig. 2.5 Coding unit, interior parts back

The coding unit comprises several key components.

The printer body contains all the mechanical and sensors necessary to drive the printhead and index the ribbon. The printer body connects to the control unit and supports the magazine.

The magazine is fitted to the printer body and guides the ribbon during printing. It is easily removed and stable when placed on a flat surface during ribbon changes.



CAUTION:

Do not place any your fingers in the opening in the main plate of the coding unit once the magazine has been removed. This as there is a small change one cuts oneself on sharp edges on parts inside the coding unit and there is a very small change one becomes trapped due to moving parts inside the coding unit.



CAUTION:

Be careful when touching / exchanging the printhead. The printhead could be very warm and has some sharp edges on which one can cut oneself.

If required a spare magazines can be used for very fast changeovers (e.g. during a production run).

2.3 Control unit

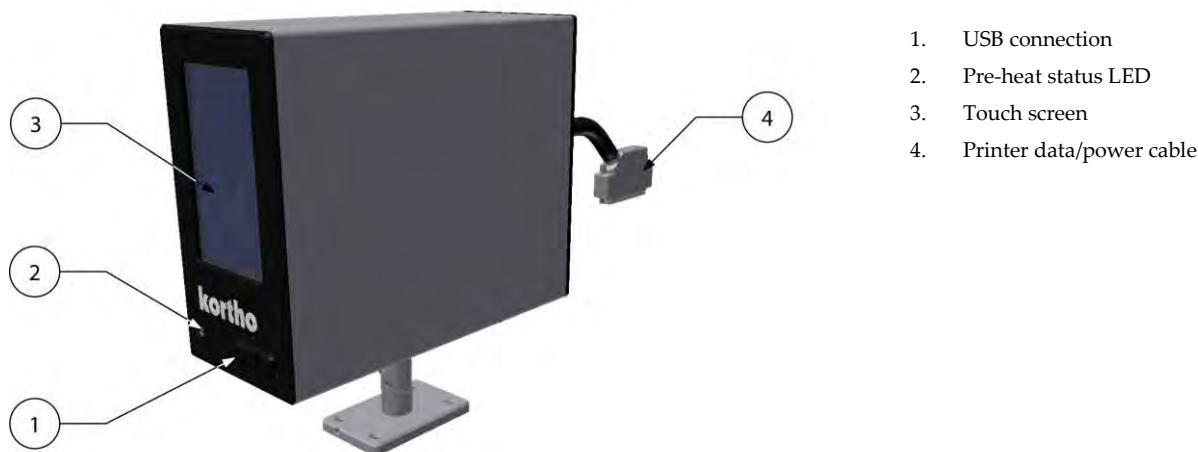

Fig. 2.6 Control unit + adjustable support



CAUTION:

Do not use an extension cable for connecting the USB thumbdrive to the control unit, but place the USB thumbdrive directly in the control unit. Using an extension cable can cause EMC interference.

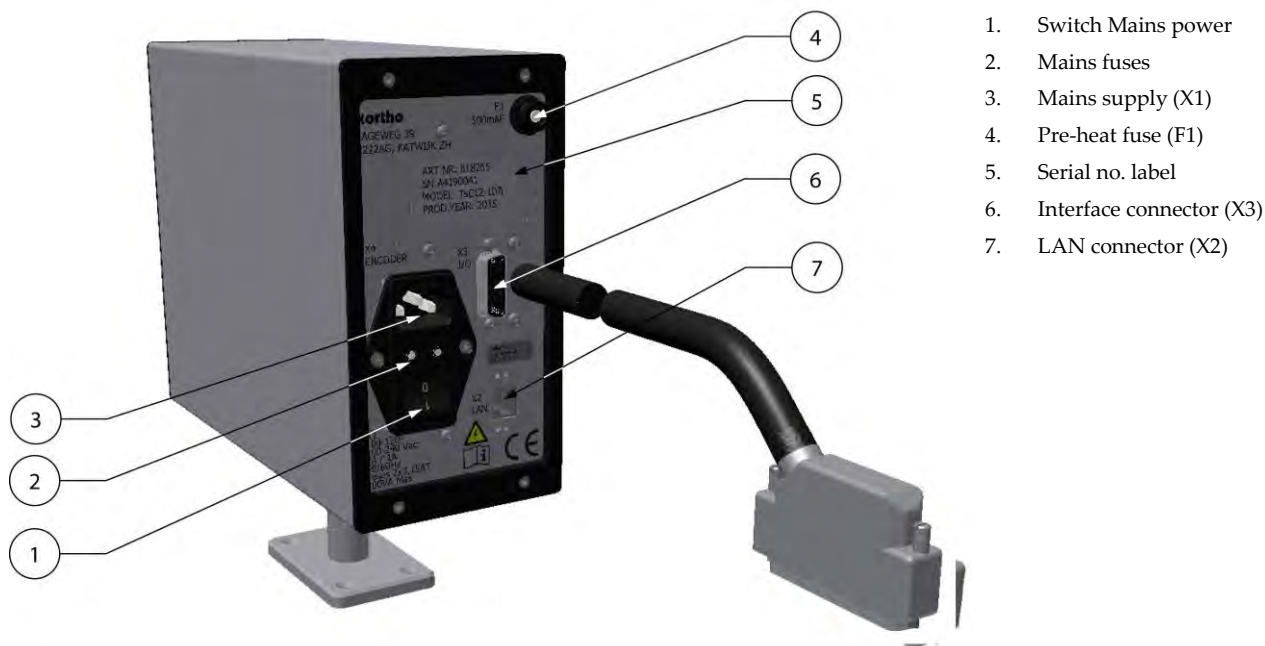
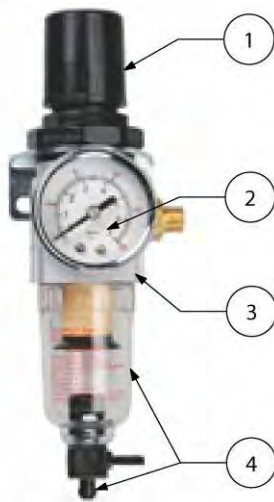

Fig. 2.7 Control unit, connections

2.4 Air supply

The printer requires an air supply that is clean and dry (ISO 8573-1:2010 [4:4:3]). The air pressure should be set to 0,4 MPa (4 bar) for the QiC 30i and 53i and to 0,5 MPa (5 bar) for the QiC 107i.



1. Pressure regulator
2. Pressure gauge
3. Air distribution manifold
4. Water separation bowl with a manual drain valve

Fig. 2.8 Air regulator

2.5 Label design

A label can be designed by QiC Draw or NiceLabel in combination with the Windows driver. Other software can be used in combination with the Windows driver, but depending on the software, most internal label functions will not be available. Please consult Korthofah or your local distributor for further information.

2.5.1 QiC Draw label design software

The label design software is called QiC Draw.

With this software package one can create labels for the QiC printer series. Besides the label design options, the program also offers several service diagnostic tools. It runs on an IBM-compatible PC with Microsoft Windows NT, 2000, XP, 7 or 8 installed.

For full details on installing and using the package, see the separate QiC Draw manual.

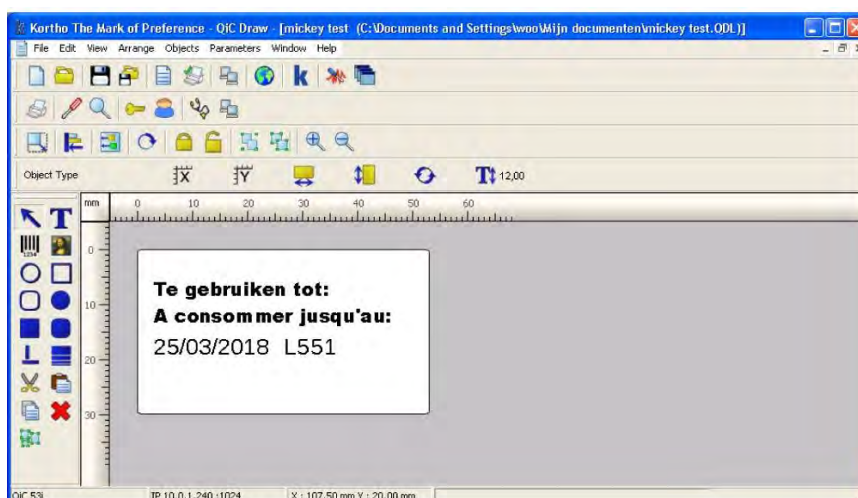

Fig. 2.9 QiC Draw main window

2.5.2 NiceLabel

Labels can also be created by using NiceLabel or any other windows based program using the Kortho printer driver for NiceLabel. When using this driver in combination with the NiceLabel software one can use the full options this software program offers including variable text and data fields. One should note that using the NiceLabel Windows driver in combination with any other program will limit the label item options to fixed items. For information about the installation of the driver and the use of the NiceLabel, see Appendix E.

3 PRINT PROCESS DESCRIPTION

3.1 Print cycle

The purpose of the printer is to print a label on a substrate. A label is digital data and is stored in the print memory of the control unit. The control unit converts the label into a bitmap. The printhead receives this bitmap pixel-column by pixel-column and uses it to fire the heating elements of the printhead.

The ribbon that is placed between the printhead and the substrate is heated by the printhead heating elements. While a heating element is hot, the pigment of the locally heated ribbon will be transferred onto the substrate. By firing the heating elements in the right sequence the selected label will be printed on to the substrate.

The printhead contains 640 heating elements (12 dots per mm at a printhead width of 53,3mm). The vertical resolution is controlled by a linear encoder that is linked to the printhead carriage. The resolution of this encoder is also 12 dots per mm.

The print cycle is initiated with a "print request" signal. The print request signal can e.g. be generated by a spot photocell, a relay switch or a PLC inside the host machine.

Once the print request signal is received by the control unit, the following sequence will be started:

1. Printhead down.
2. Printhead carriage forward.
3. Firing of the heating elements in the sequence determined by the label bitmap.

When the print is completed:

4. Printhead up.
5. Printhead backwards (ribbon will be transported at the same time).

When enough ribbon has been transported to make the next print on unused new ribbon:

6. Clutch will be activated (ribbon transport will stop).

When the printhead is back in its home position:

7. Pressure will be taken of the carriage drive cylinder.
8. Clutch will be deactivated.

When a print has been made, the bitmap will be updated, if necessary, for variable label items such as time, date and number items. When this is done, the Busy output is de-activated and the printer is ready for the next print request.

3.2 Printhead

The printhead has high productivity and reliability by using its unique face-down IC bonding method instead of the conventional wire bonding method. It is seen in a range of industrial coding and marking applications, as a versatile technology able to print on a wide variety of substrates.

The printhead consists of an alumina ceramic base plate. This base plate is covered by a glass layer, a heater line layer and finally an abrasion-resistant ceramic coating. The structure and materials chosen guarantee a high quality print and an optimal life time of the printhead.

For making a high quality print with the printhead it is important that:

- The right amount of energy is applied to the heating elements (customer setting).
- The pre-heat is set to the optimum value (customer setting).
- The printhead, with the ribbon and substrate in between, is pressed against a platen with the right force (factory pre-set).
- The ambient temperature is between 5 °C - 40 °C (41 °F - 104 °F).
- The ribbon and the substrate are matched. Various ribbons are available each with its own specific characteristics.
- The environment and especially the substrate is clean. Some materials, like small hard particles, can damage the printhead. Due to this white lines will appear in the print. This type of damage is permanent.
- The printhead maintenance, refer to section 10.1.1. Important factors in regards to this are:
 - **Abrasion:** the process of wearing down by friction—will occur during normal operation of the printer. However, it can be minimized through proper care and maintenance and by using a high quality ribbon.
 - **Contamination:** when particulate matter—such as dust—damages the printhead, it becomes contaminated.
 - **Corrosion:** Gradual deterioration of the printhead may occur because of the substrate being used, incorrect cleaning agents or the environment.
 - **Electrostatic Discharge (ESD):** Electrostatic discharge may occur due to improper handling, charging of non-conductive substrate and ribbon moving through dry air.
 - **Moisture:** If your printer is operating in a humid or damp environment, this moisture may damage the printhead.
 - **Residue:** The build-up of residue—or foreign materials—may occur with improper maintenance, incorrect cleaning agents, inferior substrate or incorrect application setup. Clean the printhead with a lint free cloth soaked in isopropanol (2-propanol or isopropyl alcohol (IPA)).

3.3 Coding unit

The coding unit can be positioned in almost any position. When positioning the system it is important to take the following issues into account:

- The magazine should face the operator for easy access and clear view on the indicators.
- Print in the opposite direction of the substrate movement. This makes sure the substrate will not move during the print process.
- When printing in a vertical position, it is preferable to print upwards.

3.4 User interface

The user interface on the control unit consists of a touch panel displaying the menu structure of operator menus and a LED indicator showing whether the system is preheating the printhead. Beside this, a multifunctional button (test print/ reset error/reset ribbon length) and 2 LED indicators are present on the coding unit.

The touch panel consists of a resistive touch screen and a TFT panel. For accurate operation it is important to apply the pressure on a relatively small area e.g. by using a stylus. To prevent using a stylus all the time, the user interface has been optimized for finger touch.

3.4.1 Menu structure

The screen is divided in three parts, see Fig. 3.1. Section 1 shows the submenus available when the printer icon is selected. When the other icons in section 3 are selected, different submenus will be shown. Section 2 is showing the status of the printer and the Start (I) \ Pause (O) button. Depending on the button selected in section 1 and 3 the content of this section will change.

The content can be settings, status information or general information. Section 3 is showing the 4 main menu options:

1. Label selection/Label management.
2. Printer settings.
3. Diagnostics.
4. Information.

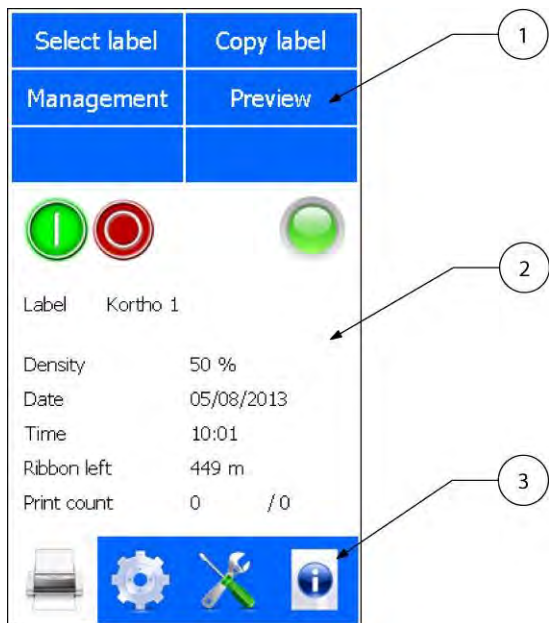

1. Section 1, sub menu items
2. Section 2, status, options and preview area
3. Section 3, main menu items

Fig. 3.1 Screen layout, main menu portrait

The standard factory setting for the menu is portrait mode. Alternatively the screen can be displayed in landscape mode. The screen can be rotated by steps of 90 degrees, see section 8.6.1.

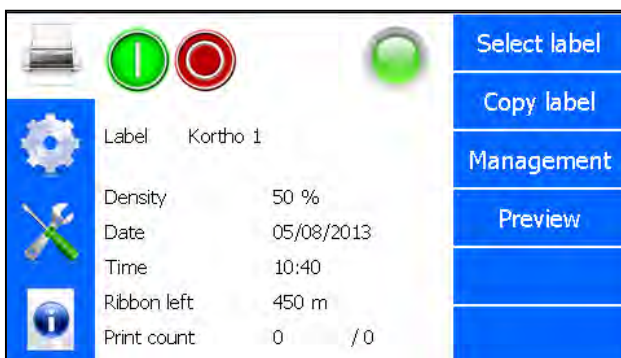

Fig. 3.2 Screen layout, main menu landscape

3.4.2 LED indicators on control unit

The status screen of the control unit shows a LED indicator which is showing the same as the status LED on the coding unit, see section 3.4.3.

The green LED indicator, on the front bottom left corner of the control unit enclosure, indicates whether the heating element for preheating the printhead is energised (heating). When starting up the printer, the LED will light continuously.

When at temperature, the LED will start flashing. If the LED remains off during printing, the temperature of the printhead is above the set temperature of the preheat setting.

The thermal printhead produces heat, so if the system is printing a lot, the printhead will be heated by the energy it produces and the preheating system simply shuts down.

3.4.3 LED indicators and front button on coding unit

There are two LED indicators and a single front button (S) mounted on the coding unit. This is particularly useful for operators during the replacement of ribbon or solving a ribbon break as all the necessary controls are located above the magazine.



Fig. 3.3 LED indicators and front button

The front button has several functions:

1. Following a ribbon break, printer malfunction or head being lifted: pressing the front button (S) will attempt to reset the condition. However, if the condition remains e.g. the ribbon breakage is not recovered, then the button will not reset the printer.
2. If the printer is ready to print i.e. label loaded, head locked and no printer fault: pressing the front button will trigger a single print when the system is set in pause mode.
3. After placing a new roll of ribbon: pressing and holding the front button for about 4 seconds will reset the ribbon left value to the length of a full roll.
4. After a firmware update or if the system is not responding properly: pressing the front button while switching on the printer will reset most of the variables to the factory setting. To reset the control unit:
 1. Press front button (S).
 2. Switch on the control unit and keep front button pressed
 3. When the status led starts flashing, release the front button.

The Power LED shows if the 5VDC is present in the coding unit

The Status LED displays several conditions:

- Constant green: System ready for printing.
- Blinking green: No label loaded.
- Fast blinking green: Internal data communication activity.
- Constant orange: Ribbon break, head unlocked or printer fault.
- Blinking orange: Low ribbon warning.
- Blinking red/orange: System reset.

3.4.4 Keyboard

Data and settings can be entered through a keyboard that will be displayed on the TFT panel.

The keyboard has four screens. The first screen is shown below. The tiny round indicators at the bottom of the screen show which of the four keyboard screens is currently displayed. One can select another keyboard by either using the relevant buttons or by swiping over the round indicators at the bottom of the screen.

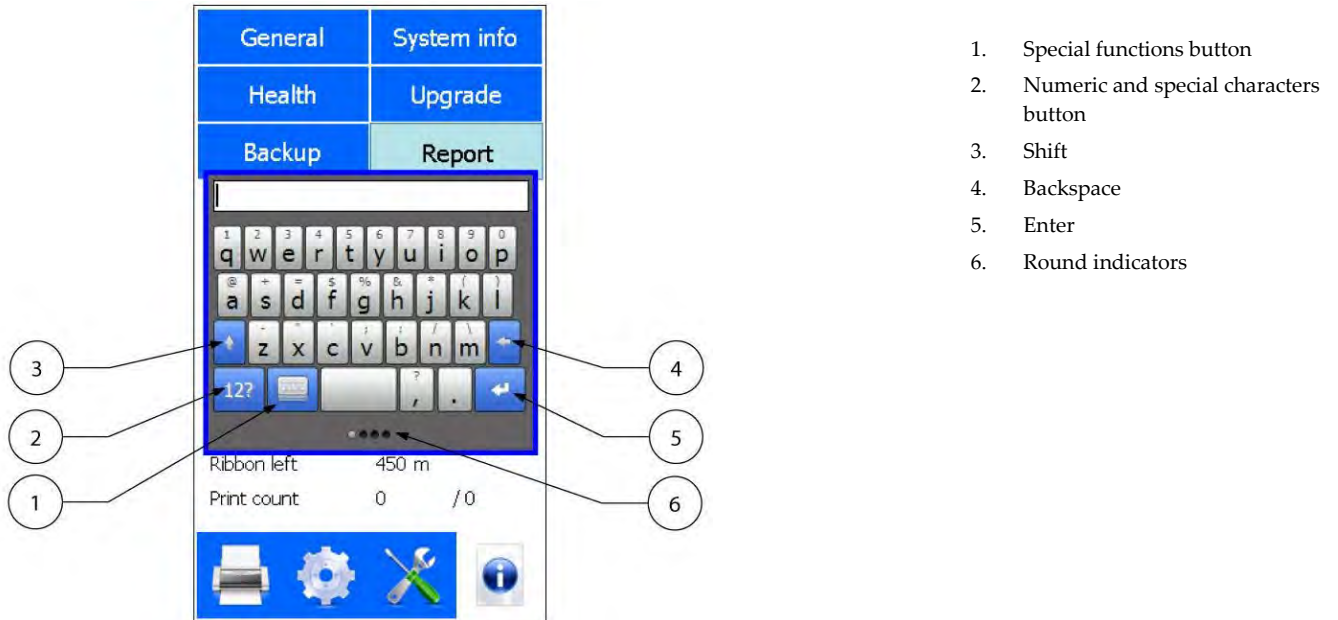

Fig. 3.4 First keyboard screen

To use the keyboard superscript alphanumerics:

1. Touch and hold the desired key.
2. Drag your finger to the left or right to select the character of choice.

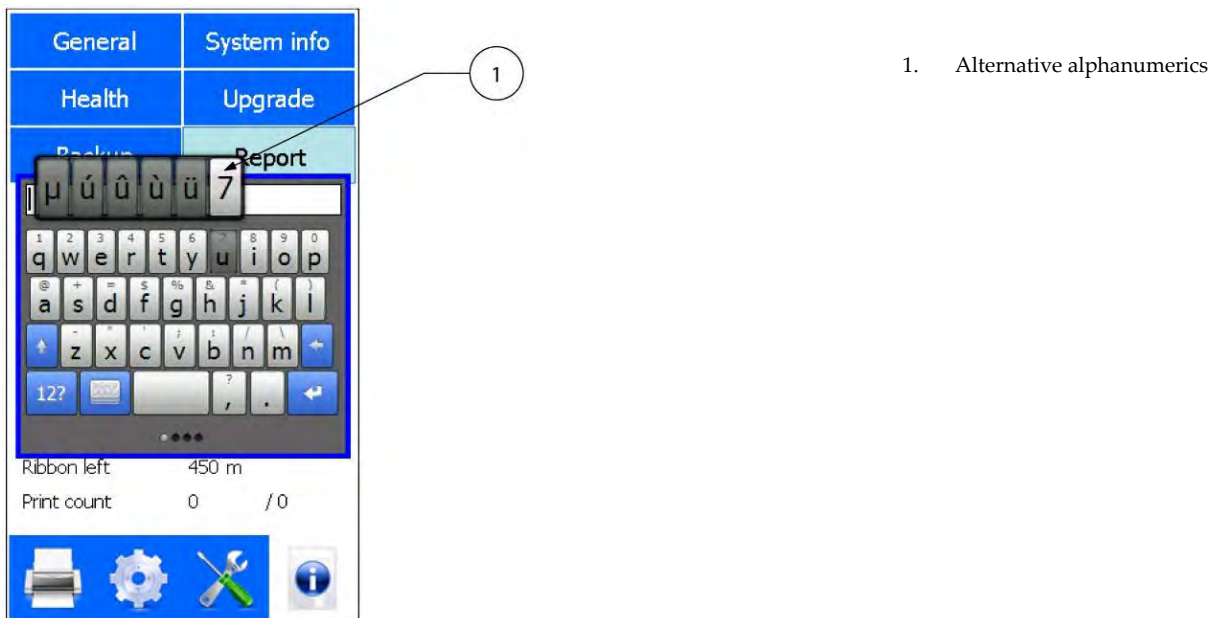

Fig. 3.5 First keyboard screen, alternative alphanumerics

An alternative way to select a digit is to touch the numeric and special characters button. The second keyboard screen will appear.



Fig. 3.6 Second keyboard screen, numeric and special characters

For entering commonly used text the third keyboard screen can be used. One can store frequently used texts in this keyboard. To enter this screen either swipe over the round indicators at the bottom of the screen or touch the special functions button in the first screen to enter the fourth screen and touch FX.

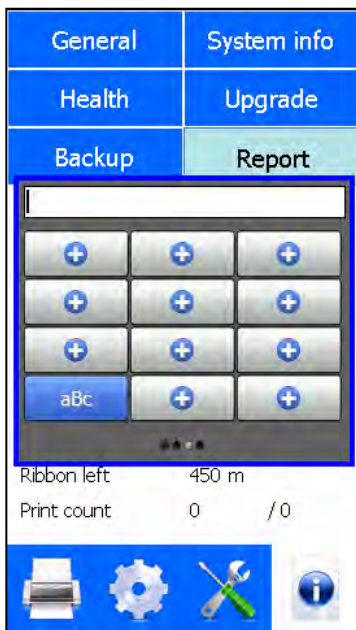

Fig. 3.7 Third keyboard screen, commonly used text

To program the buttons in the third screen:

1. Touch the special functions button on the first keyboard screen.
2. Touch the *FX* button.

The screen as shown in Fig. 3.7 will appear.

3. Touch one of the + buttons and enter the data to be stored (only one line can be stored), see Fig. 3.8.



Fig. 3.8 Programming third keyboard screen buttons, entering text

4. Touch the *OK* button to store the text.

The button is now labelled with the text entered, see Fig. 3.9. Touching this button enters the text where required.

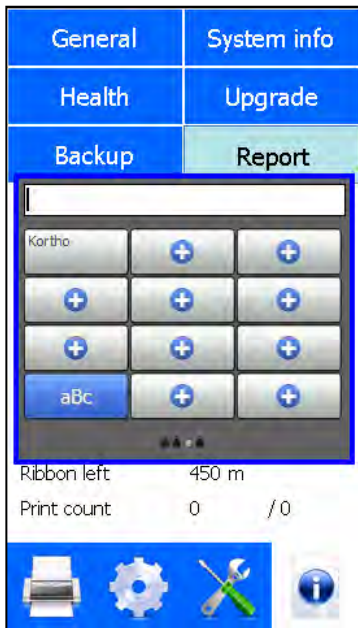

Fig. 3.9 Programming third keyboard screen buttons, entering text

The text in a button can be deleted or modified later on.

A text placed by using the third keyboard screen will be treated as normal text, so the text can be deleted or modified if required.

PRINT PROCESS DESCRIPTION

To edit text and use cursor controls, touch the keyboard button. This following screen will appear:



Fig. 3.10 Fourth keyboard screen, edit text and use cursor controls

To return to the first screen touch the *aBc* button.

To return to the second screen touch the *12?* button.

To return to the third screen touch the *FX* button.

Beside the standard keyboards there is a numeric keyboard available for all numeric items/entries, see figure Fig. 3.11.

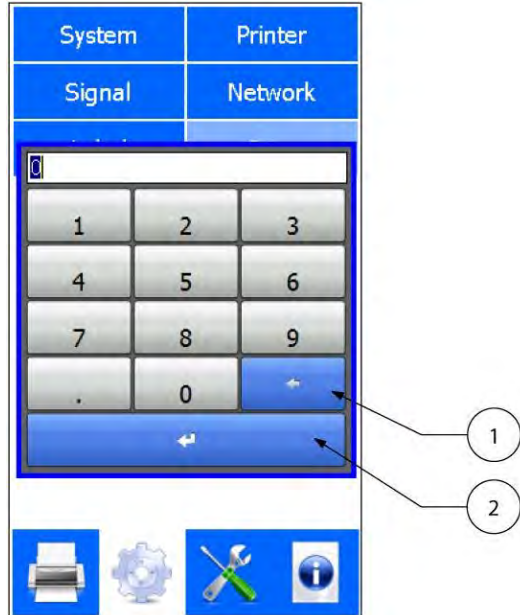

1. Backspace
2. Enter

Fig. 3.11 Numeric keyboard

3.4.5 System information

The firmware versions installed on the control unit can be displayed on screen by pressing *System Info* in the Information menu.

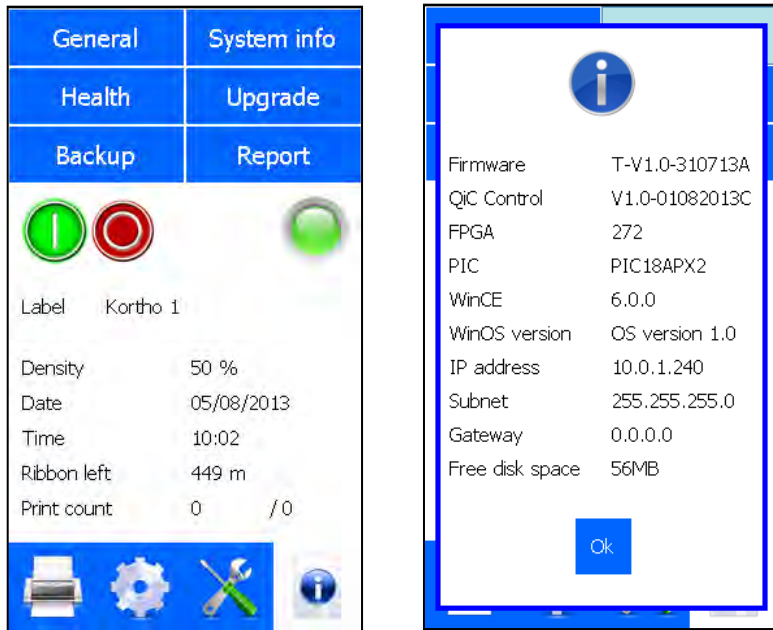

A B
Fig. 3.12 Entering the System information screen

3.4.6 Menu structure

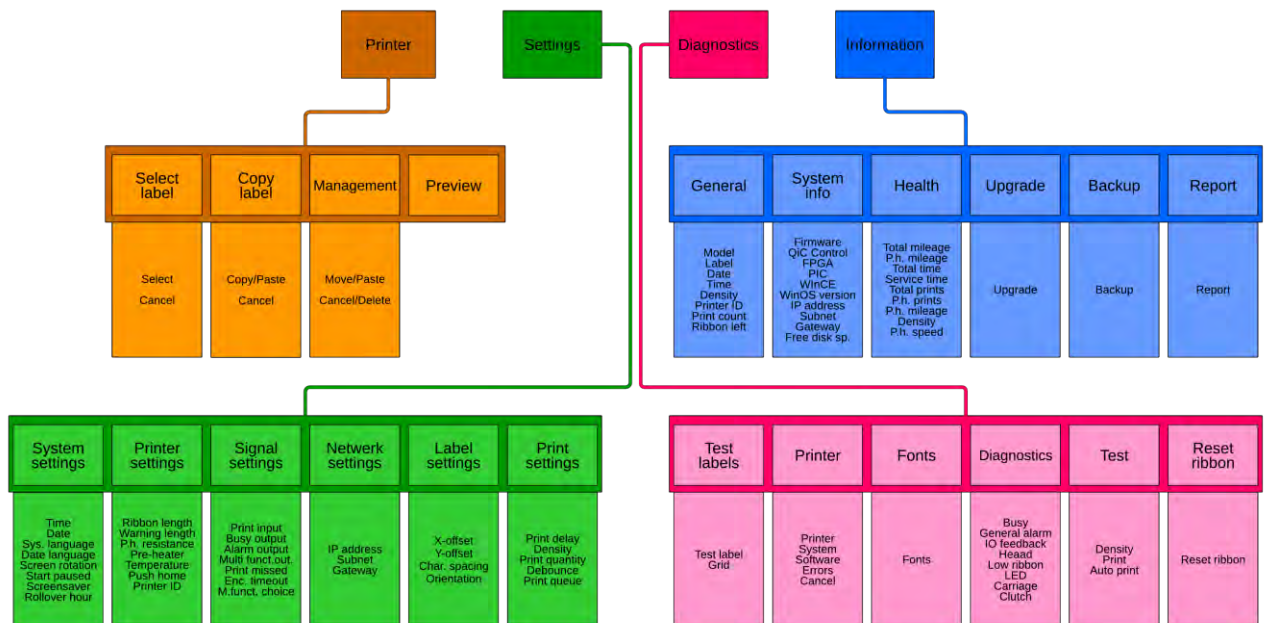

Fig. 3.13 Standard menu structure
Refer to Appendix F for a full-scale sheet of the menu structure.

4 SAFETY

This product is designed to conform to all applicable directives, and their relevant harmonized standards, of the European Council.

4.1 General

This chapter gives an overview of all safety notes mentioned in this manual.

4.1.1 Warning messages

- Turn off power before performing maintenance tasks.
- When removing covers all air and mains power should be disconnected.
- The mains power and air supply must be disconnected when replacing the printhead.

4.1.2 Caution messages

- Make sure the interface cable is no longer than 30m. Using a cable longer than 30m can cause EMC interference.
- Do not place any your fingers in the opening in the main plate of the coding unit once the magazine has been removed. This as there is a small change one cuts oneself on sharp edges on parts inside the coding unit and there is a very small change one becomes trapped due to moving parts inside the coding unit.
- Be careful when touching / exchanging the printhead. The printhead could be very warm and has some sharp edges on which one can cut oneself.
- Do not use an extension cable for connecting the USB thumbdrive to the control unit, but place the USB thumbdrive directly in the control unit. Using an extension cable can cause EMC interference.
- Always follow the Safety guidelines presented in the SDS of the cleaning solution used.
- If the print head resistance is set incorrectly the print head can be damaged resulting in a poor print quality or no print at all.
- These settings will be set during installation; only a trained engineer should change them.
- If the label is offset too much one could lose parts of the print. To prevent the most common issues, the system will perform a check on the Y-offset.
 - When a new label is loaded: the system will check whether the new label will be completely printed with current Y-offset. If not the Y-offset will be reset to 0.
 - When the Y-offset is changed: the system will check whether the current label will be completely printed with the new Y-offset. If not the system will show a warning telling the Y-offset value is too high.
- If not enough heat is applied to the ribbon, the pigment that makes up the printed label may not adhere correctly to the product. If too much heat is applied to the ribbon it may not adhere correctly or potentially the print head could be damaged.
- Always use the lowest density setting possible, this as the lifetime of the printhead will be influenced by the density setting.

- If a print request is received during the current print cycle, the system will make a print right after the current print has been made. When the substrate has not moved, it will place the print directly over the previous print. If the substrate normally starts moving after a print, the system will attempt to make a print on the substrate which could be moving. In that case, the possibility exists that the substrate will break, the ribbon will break or other errors will occur.
- Under NO circumstances should a sharp tool be used while maintaining the printhead. Any damage caused by sharp object will void the warranty.
- Before removing the printhead the power and air should be disconnected. All maintenance should be carried out by qualified personnel, preferably those that have attended the formal training session offered by Korthofah. Refer to section 10.5.
- Do not use any cleaning solutions as this can permanently damage the encoder strip.
- Read Printhead safety notes before handling the thermal printhead. Always ensure anti-static precautions are observed when handling a thermal printhead or printed circuits boards or they might get damaged.
- Be careful when touching / exchanging the printhead. The printhead could be very warm and has some sharp edges on which one can cut oneself.
- The cable plug should be gently taken out of the printhead socket taking care not to pull directly on the wires.
- Make sure the connector is secured by the connector clamp (2).

4.1.3 Beware messages

- Many of the features in this section only work when the printer is paused. Pause the printer by pressing the *Pause* icon. When paused the *Pause* icon is brightly lit.
- The Test label will remain selected until a new label is selected or the system is switched off and on again. Make sure another label is selected when starting up the production, otherwise the Test label will be printed during production.
- When the control unit is rebooted or switched off the error list will be cleared.
- The font list must match the font list in the label design program used to design the labels. If a non-installed font is used in the label as internal font the printer will not be printed at all. Due to this the printed label will miss one or more items. In the worst case the label will not be printed at all and a range of error messages can come up e.g. font error and no label loaded.
- The pre-installed Arabic font may only be used for printing digits, e.g. for time, date and number items. As not all alphanumeric characters are available in the font, using the font for text will lead to characters not being printed.
- The pre-installed Arabic font may only be used for printing digits, e.g. for time, date and number items. As not all alphanumeric characters are available in the font, using the font for text will lead to characters not being printed.
- System Diagnostics should only be run when the system is paused. Often the tests require that the system air supply is attached. Only a trained service engineer should run these tests.
- The system will print as fast as possible with the current settings and label. The system will print as fast as possible with the current settings and label. This is very fast and should not be used often. To observe whether the printer is capable of reaching the maximum prints per minute is a useful test though. One can slow the number of prints per minute down by increasing the delay value. This is only a diagnostic function and should only be used by qualified personnel. This is only a diagnostic function and should only be used by qualified personnel.

- If the label needs to be downloaded through a USB thumbdrive one should set the driver accordingly, see Downloading a label through USB, Installation of the driver. The description below is based on the situation in which the label is sent to the printer through the Ethernet.
- Before a label be downloaded through a USB thumbdrive it needs to be printed to a Printfile (*.prn). It is not possible to download the original label file to the printer.
- To guarantee a good print result it is important that the label is designed for the printer to which one would like to download the label.

4.1.4 Notes

- All external equipment that is connected to the control unit interface must be double insulated to qualify the whole installation as a separated extra-low voltage (SELV, Class II) system.
- Refer to Appendix D, Connections, for the connection options.
- Printing the Grid test label with a low density setting (e.g. 10%) makes it easier to see if the printhead is level with the platen.
- When the system parameter *Start paused* is set to *No*, the printer will start printing as soon as the print engine is powered up and a print request is received. The print engine is active before the Main menu is shown. Refer to subsection 8.6.1.
- During the boot process the *Screen calibration* screen will be shown. Do not touch this screen unless the screen calibration of the control unit is incorrect. Refer to section 9.3.
- If a print request is received during the pause mode, a popup will appear on screen, showing “Error 44: the printer is paused. Start the print process to continue.” .
- The directories that are stored on the USB thumbdrive are shown in pink, while the directories that are stored in the label memory are shown in yellow.
- The status LED will turn orange.
- The print engine is ready to print before user interface has completely booted. As soon as the print engine is ready the printer will make a print as soon as a print request signal is applied.
- Using this option will decrease the number of prints per minute (PPM) because it takes time to push the printhead carriage back into the home position. Once the carriage is pushed back for the set amount of milliseconds, the system will make the print.
- When the print queue contains a print request, this print request will be executed directly after the current print has been made. When multiple print requests come in during a print cycle, only 1 will be stored in the print queue. The others are simply disregarded. This in turn implies that the Print missed error or warning is not active when the print queue is activated
- .When there are more languages than fit on screen, one can touch the screen and drag up and downwards to select the required language.
- To view errors 4 to 10 touch the screen and drag the messages upwards. This will scroll them into view.
- If an error occurs more than once, sequentially, the error will only be displayed once. The amount of times an error has occurred sequentially will be mentioned between brackets, e.g. see Error 5 in Fig. 9.8.
- The printer is supplied with a set of internal fonts installed. The fonts shown in the picture above are the pre-installed fonts. These fonts can be replaced by other fonts using QiC Draw.

- Since the front button and both encoders are located in the coding unit, the possible problem could also be in the wiring to the control unit or a defective front button switch or encoder device.
- Make sure only upgrade file of the QiC Control version that should be installed is present on the USB thumbdrive. Otherwise there is a chance that the wrong version will be installed.
- Occasionally repositioning the platen can average the wear and increase the life span of the platen.
- Removing the air pressure allows the head to lower and provide easier access to the two screws.

4.2 Control unit

4.2.1 General information

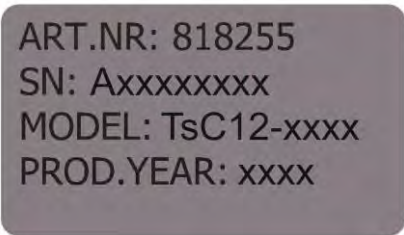

Fig. 4.1 Control unit identification label

The part number and serial number of the control unit can be found on the identification label which is also located at the back of the control unit, see Fig. 4.1. The coding unit has its own part number and serial number. The coding unit identification label can be found on the base plate of the coding units (take out the magazine).

The contact details of Korthofah can be found on the back of the control unit, see Fig. 4.2 .

4.2.2 Power supply

For safe operation, the power cable to the control unit must be connected to a properly grounded single-phase supply of the appropriate voltage. The power supply must comply with the power supply information that is written on the back of the control unit, see Fig. 4.2 and refer to Appendix A.



Fig. 4.2 Power supply information

SAFETY

Verify that no significant potential difference exists between the single-phase protective earth of the printer and the frame ground of the host machine.

The wire colour code for the supply cable is: BROWN for Line (L)

BLUE for Neutral (N)

GREEN/YELLOW for Protective Earth (PE)

When installing or servicing the equipment ensure that the host machine is switched off.



Note:

All external equipment that is connected to the control unit interface must be double insulated to qualify the whole installation as a separated extra-low voltage (SELV, Class II) system.

4.2.3 Precautions before power-up

Check at every printer power-up if all these connections are secured:

1. The cable/conduit between the control unit and the coding unit.
2. The mains power plug (X1).
3. The air connection (on the coding unit).
4. The interface cable (X3) (Info: host-interface).
5. The LAN cable (X2) (Option).

4.2.4 Precautions when opening the control unit



Fig. 4.3 Attention label for opening control unit

The control unit has an attention label at the back (Fig. 4.3) to alert the user to read the manual before opening the control unit.

ALWAYS disconnect the power to the control unit before removing any connectors or covers:

- Switch off the control unit.
- Remove the plug from the mains power supply.
- **DO NOT** operate the printer when any cover is removed.

- DO NOT LEAVE tools, screws or other parts inside the control unit when re-assembling the equipment.
- USE all four screws to fasten the covers.

4.3 Anti-static precautions

4.3.1 Printhead

The printhead is a static sensitive device, which can be damaged if it is touched without the necessary electrostatic discharge (ESD) precautions being taken. The ESD precautions involve the use of a grounded wrist strap and/or conductive work mat.

During installation, servicing and handling of the printhead, the printhead must be protected from electrostatic discharges. The printhead can be compared with a normal CMOS circuit and must be ESD protected accordingly to avoid later problems caused by discharges.

4.3.2 Printed circuit boards

The printed circuits boards can be damaged if they, or the connectors connected to the printed circuit board, are touched without the necessary electrostatic discharge (ESD) precautions being taken. The ESD precautions involve the use of a grounded wrist strap and/or antistatic work mat.

During installation, servicing and handling of a printed circuit board it must be protected from electrostatic discharges.

5 TRANSPORT & STORAGE

5.1 Printer equipment

5.1.1 Shipping and handling

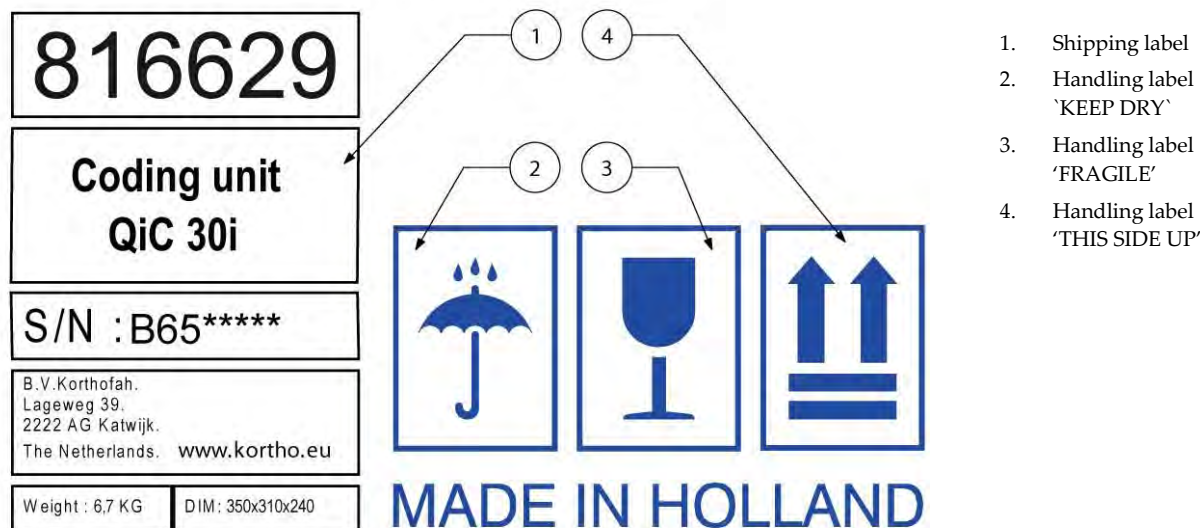

Fig. 5.1 Shipping and handling labels

The original packaging for the QiC i-series is labelled with similar shipping and handling labels as shown in Fig. 5.1. The handling labels must be visible from all sides.

- Refer to label (1) of Fig. 5.1 for shipping information.

Part.nr.	Description	Weight	Dimensions (mm)
816629	Coding unit 30i	6,7 kg	L350xW310xH240
816311	Coding unit 53i	8,7 kg	L400xW340xH380
815722	Coding unit 107i	9,9 kg	L400xW340xH380
817332	Control unit TsC12, QiC 30i	4,4 kg	L350xW310xH240
818242	Control unit TsC12, QiC 53i	4,4 kg	L350xW310xH240
818255	Control unit TsC12, QiC 107i	4,7 kg	L350xW310xH240

- Store the package in a dry location, refer to label (2) of Fig. 5.1.
- Handle the package with care, because the printhead is fragile. Refer to label (3) of Fig. 5.1.
- Keep the package upright in all cases, refer to label (4) of Fig. 5.1.

5.1.2 Pre-transport procedure

The transport distance and time is determinative for the pre-transport procedure:

For movement within a building:

1. Keep the coding unit upright with the printhead in its upper position to avoid the printhead gets damaged during the transport.
2. Avoid shocks and vibrations during the transport.

For movement from building to building:

1. Keep the coding unit upright with the printhead in its upper position to avoid the printhead gets damaged during the transport.
2. Avoid shocks and vibrations during the transport.
3. Use original or equal packaging for the printer equipment.
 - a. Label the box with 'keep dry' labels like label (2) of Fig. 5.1 (visible at all sides).
 - b. Label the box with 'fragile' labels like label (3) of Fig. 5.1 (visible at all sides).
 - c. Mark the top of the box with 'this side up' labels like label (4) of Fig. 5.1 (visible at all sides).

5.1.3 Pre-storage procedure

The printer storage location and time is determinative for the pre-storage procedure:

When still mounted on the support but idle for at least one month:

1. Keep the coding unit upright with the printhead in its upper position to avoid the printhead gets damaged.
2. Avoid shocks and vibrations during the transport.
3. Place a dust cover or bag over the coding unit.
4. Place a dust cover or bag over the control unit.

For storage prior to distribution:

1. Keep the coding unit upright with the printhead in his upper position to avoid the printhead gets damaged during the handling and the transport.
2. Avoid shocks and vibrations during the handling and the transport.
3. Store in the original or equal packaging.
 - a. Label the box with 'keep dry' labels like label (2) of Fig. 5.1 (visible at all sides).
 - b. Label the box with 'fragile' labels like label (3) of Fig. 5.1 (visible at all sides).
 - c. Mark the top of the box with 'this side up' labels like label (4) of Fig. 5.1 (visible at all sides).
4. Store the printer, in the original or equal packaging with topside upwards, in a dry place at ambient temperature between 5 °C and 40 °C.

5.2 Ribbon

The ribbon should be stored at a temperature of about 20°C. Do not expose the ribbon to direct sunlight and/or extreme humidity.

5.2.1 Handling and storage

Handling

: As with all chemicals, good industrial hygiene practices should be followed when handling this material.

Always wash hands thoroughly after handling and before eating, drinking, or using tobacco products.

Avoid inhalation of ink particles, in case of flaking.

Storage

: Keep in a dry and cool place.

Specific use(s)

: Use only as a marking tool to identify products.

5.2.2 Transport information

Refer to the latest Material Safety Datasheet for more detailed and accurate information.

The product is not subject to transport regulations (ADR/RID, IATA and IMO).

Keep the ribbon in a closed box in a dry place and cool place. This is valid for all kinds of transport.

6 INSTALLATION

6.1 Requirements

6.1.1 Provided by the customer:

- Power:

For 30i and 53i: Voltage rating 100-120Vac / 200-240Vac, current rating 1,55A / 0,75A, frequency rating 50 / 60Hz, power rating 150VAmax - including clean protective earth.

For 107i: Voltage rating 100-120Vac / 200-240Vac, current rating 2A / 1A, frequency rating 50 / 60Hz, power rating 200VAmax - including clean protective earth.

The electrical circuit to which the printer is connected must be equipped with a 30mA residual current device (RCD).

- A print request-signal (e.g. output of the host machine or a photocell signal).
- Sufficient space for installation and operation.
- Compressed air, dry and oil free (ISO 8573-1:2010 [4:4:3]), with a pressure of 0,4 MPa at the printer (0,5 MPa for QiC 107i). Input to the air regulator should be 0,7 MPa to 0,8 MPa. Distance between regulator and printer should be as short as possible and no longer than 3m. The air connection on the coding unit has an outer diameter of 6mm and an inner diameter of 4mm. The minimum inner diameter of the air tubing must be 4mm.

Optional:

- An error input on the host machine. This will stop the host machine when the printer reports an error (general printer alarm).
- A warning-signal input on the host machine (warning alarm).
- A busy-signal input on the host machine. So the host machine can detect that the printer is in a print cycle (printer busy).



Note:

Refer to Appendix D, Connections, for the connection options.

6.1.2 Equipment

- Printer set, see section 6.2.1.
- Printer bracket, see section 6.3.1 and 6.3.2.
- Air reducer, see section 6.3.3.

6.2 Unpacking

6.2.1 Coding unit

The coding unit consist of two main parts, the printer body that hold the printhead and the magazine that holds the ribbon.



1. Coding unit
2. Magazine

Fig. 6.1 Coding unit

6.2.2 Control unit TsC12

The control unit is used for controlling the coding unit and holds the labels. The control unit can be mounted with the standard bracket (optional).

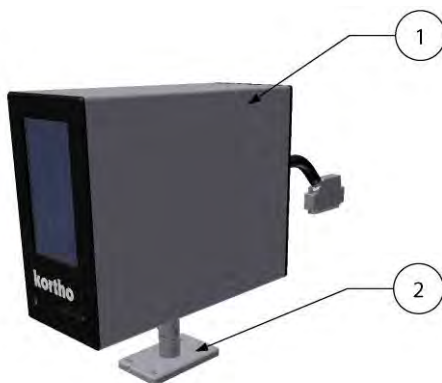

1. Control unit with mains power cord
2. Bracket
3. Manual (on USB thumbdrive - not shown)

Fig. 6.2 Control unit TsC12

6.3 Mounting the coding unit

6.3.1 Coding unit mounting support

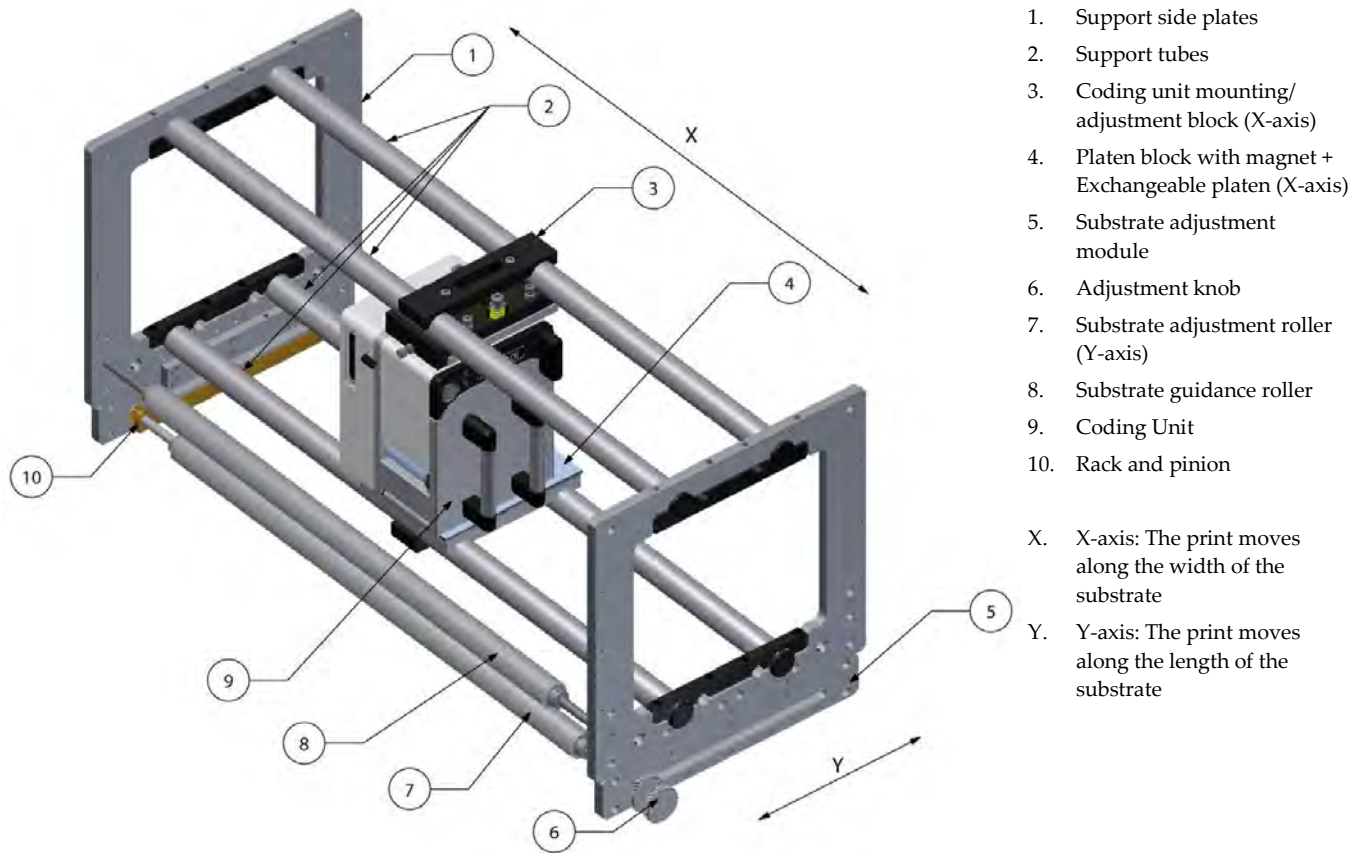

Fig. 6.3 Positioning of the print

Assuming a mounting support is available:

1. Find a suitable location on the host machine for mounting the coding unit.
2. Make sure this location does not prevent people doing their job, there is sufficient light present for operating the printer and for maintenance and that this location is accessible for operating the printer and for maintenance.
3. Mount the substrate adjustment module on the mounting support (substrate runs first under the coding unit, then second through the substrate adjustment module and then to the seal area of the host machine).
4. Mount the coding unit mounting support on the host machine.
5. Fit the coding unit to the mounting/adjustment block. (the mounting screw for the continuous printer Fig. 7.4 item 8 is not used with intermittent printer).
6. Fit the coding unit with adjustment block and the platen on the support tubes.
7. Slide the coding unit and the platen to the position (X-axis) where the print should be printed.
8. Tighten the mounting screws of the coding unit's adjustment block and the platen.

6.3.2 Substrate adjustment

On intermittent packaging machines the substrate stops and starts at (ir)regular intervals. The printer is provided with a print request on these machines during the interval that the substrate has stopped.

INSTALLATION

The print position can be moved with the substrate adjustment roller, Fig. 6.4 item 3, between the top and bottom of the package. Be aware that the substrate contains an amount of prints/packages between the print area and the seal area. So a substrate adjustment takes only effect after a certain amount of prints.

The package length must be smaller than twice the rack and pinion length (L_y) of substrate adjustment roller package length. The print area can only then be positioned anywhere between the top and bottom of the package.

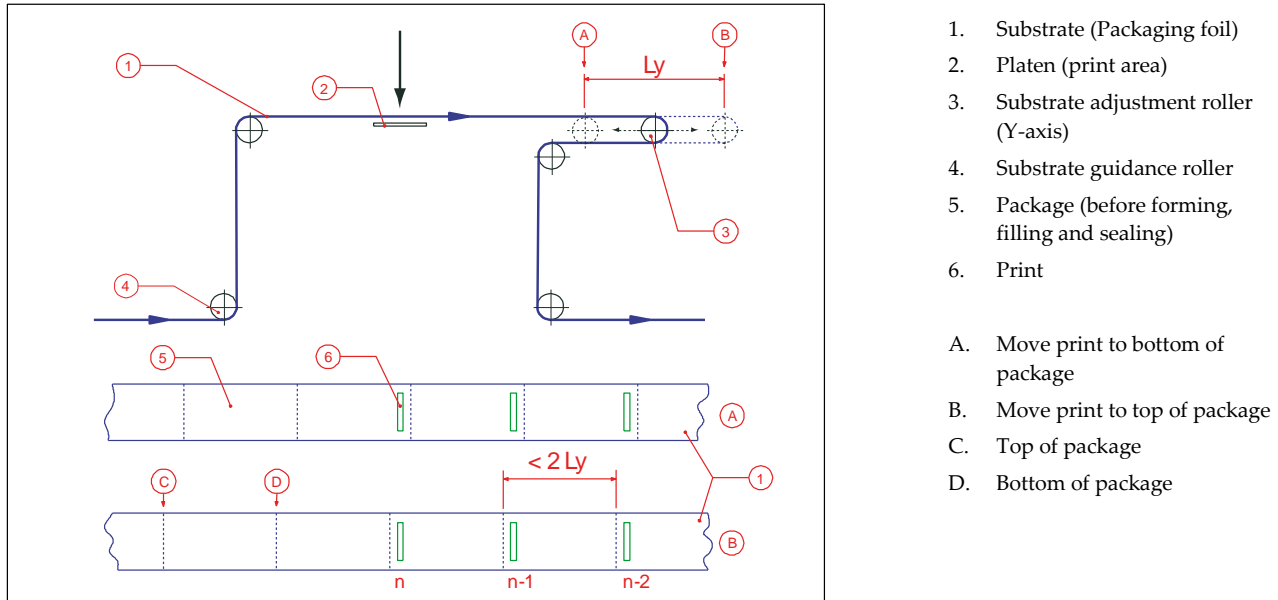

Fig. 6.4 Substrate adjustment.

6.3.3 Air supply

1. Place and connect the air regulator to the air supply and the coding unit.
2. Adjust the pressure to 0,4 MPa (0,5 MPa for QiC 107i).

6.4 Mounting the control unit

1. Find a secure location, which is easily accessible for operators, to mount the control unit. Refer to Appendix B, Dimensions Control unit for the dimensions of the mounting holes.
2. Locate the control unit on a position near the coding unit bracket and install the cables so that the coding unit can rotate and move back and forth within the dimensions of the bracket.
3. Check whether all of the cables are long enough to be connected to the connectors on the back of the control unit. If not, correct it by relocating either the coding unit or the control unit and/or extend the cable(s) if possible (the cable between the coding unit and control unit should not be extended).
4. Connect the interface cable to the host machine. Use the electrical diagram, Appendix D X3 Circuit diagram (input) and X3 Circuit diagram (output), to determine which interface option suits best with the host machine.



CAUTION:

Make sure the interface cable is no longer than 30m. Using a cable longer than 30m can cause EMC interference.

5. Connect the interface cable to the interface port (X3).
6. Connect the control/data cable, between the control unit and the coding unit (fixed length).
7. Connect the control unit the local network if required (X2 - optional).
8. Connect the mains supply (X1).

7 COMMISSIONING

This part describes the commissioning of a typical printer application.

7.1 Initial setup

7.1.1 Load the ribbon on the magazine

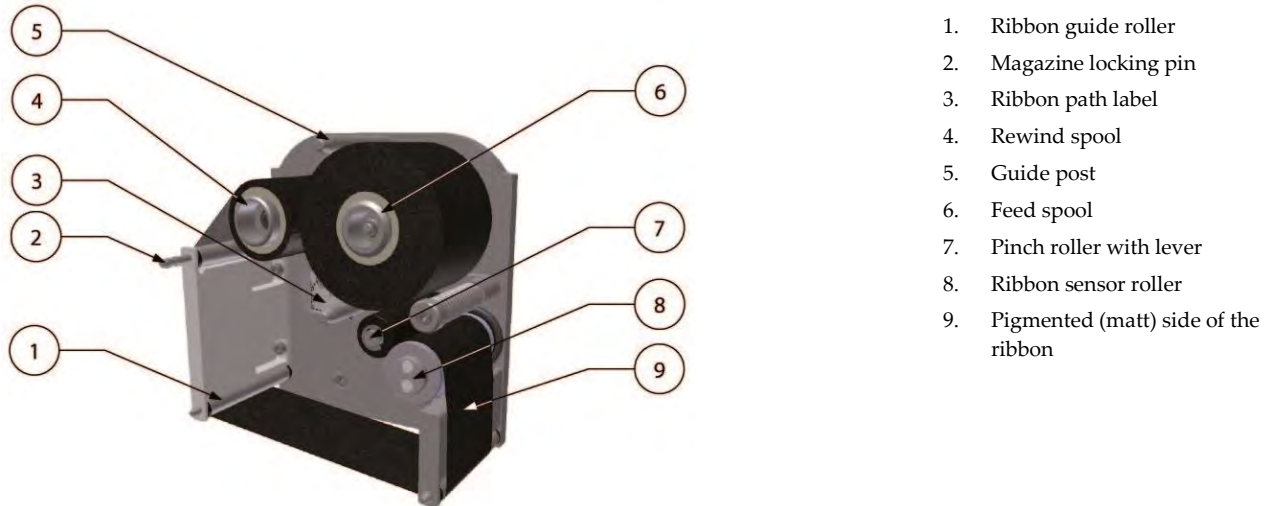

Fig. 7.1 Ribbon magazine.



CAUTION:

Do not place any your fingers in the opening in the main plate of the coding unit once the magazine has been removed. This as there is a small change one cuts oneself on sharp edges on parts inside the coding unit and there is a very small change one becomes trapped due to moving parts inside the coding unit.

1. Check and clean the ribbon sensor roller.
2. Place an empty core on the rewind spool (4), check whether the pin slides in the notches of the empty core.
3. Slide the new ribbon roll on the feed spool (6), (refer to the ribbon path label (3) in the magazine for the correct way to load the new roll; the matt side should face the substrate).
4. Open the pinch roller and guide the ribbon along the pinch roller and ribbon sensor roller.
5. Guide the ribbon along the guide rollers (1).
6. Tape the end of the ribbon to the empty core and rotate the rewind spool a few turns clockwise until the ribbon is tensioned.
7. Check whether the magazine handle is positioned in the open position (push and turn clockwise).
8. Place the magazine in the coding unit. Use the guide post (5) to place the magazine properly.
9. Lock the magazine by pushing the magazine handle in and turning it anti-clockwise.

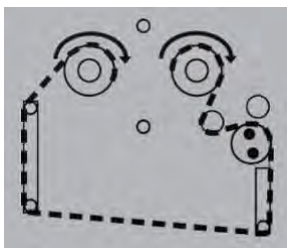
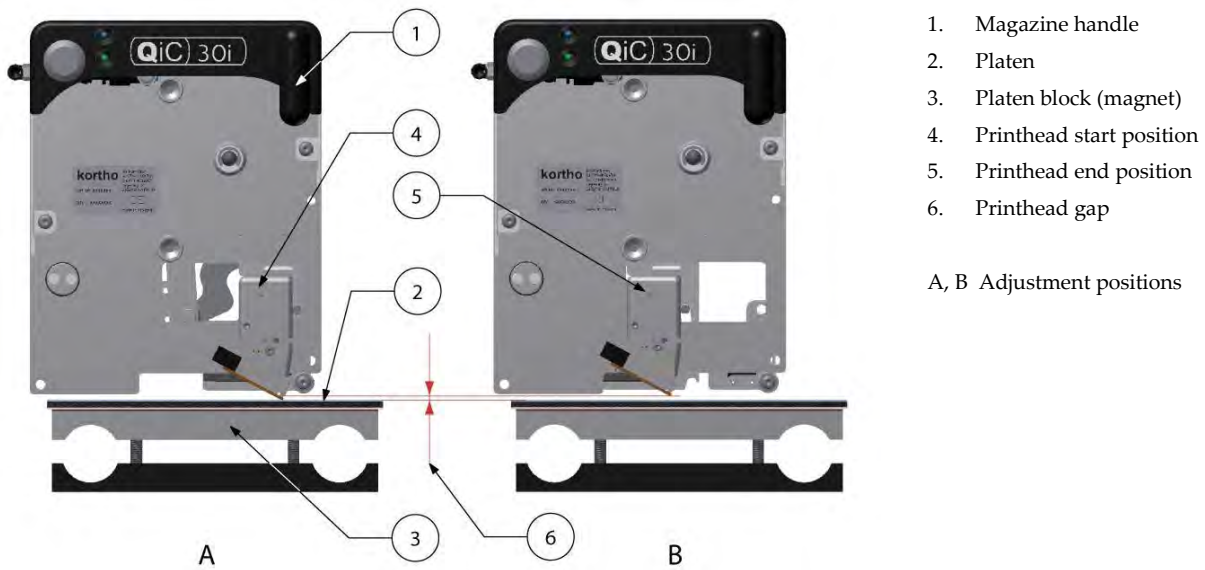

Fig. 7.2 Ribbon path label.

7.1.2 Aligning the printhead to the platen



- 1. Magazine handle
 - 2. Platen
 - 3. Platen block (magnet)
 - 4. Printhead start position
 - 5. Printhead end position
 - 6. Printhead gap
- A, B Adjustment positions

Fig. 7.3 Adjustment of printhead gap.

To achieve a good and equal print quality over the complete print area the distance between the printhead and the platen (the printhead gap) should be equal spaced during the complete print stroke. So along the print stroke (begin and end position) and left and right side of the printhead.

Use the mounting/adjustment block to align the printhead parallel to the platen, see section 7.3:

1. Connect the Coding Unit to the air supply unit and set the system operating pressure at 0.4 MPa (0,5 MPa for QiC 107i) using the air regulator.
2. Push (inward) and turn the magazine handle (1) clockwise to unlock the magazine.
3. Remove the magazine.



CAUTION:

Do not place any your fingers in the opening in the main plate of the coding unit once the magazine has been removed. This as there is a small change one cuts oneself on sharp edges on parts inside the coding unit and there is a very small change one becomes trapped due to moving parts inside the coding unit.

4. Align the platen block (3).
5. Loosen the lock screw Fig. 7.4 (7) of the adjustment block.



CAUTION:

Be careful when touching / exchanging the printhead. The printhead could be very warm and has some sharp edges on which one can cut oneself.

6. Move the printhead carriage to the start position (4) (at the side of the magazine handle).
7. Use the four adjustment screws Fig. 7.4 (5) to align the printhead parallel to the platen (gap (6) should be 3mm).
8. Move the printhead carriage to the end position (5).
9. Align again with the four adjustment screws Fig. 7.4 (5) (The gap should be 3mm).
10. Repeat step 5 to 9 until the printhead to platen gap is 3mm at both positions.
11. Tighten the two spring screws Fig. 7.4 (10) and then turn them 3 full turns anti-clockwise to loosen them a bit. This will result in maximum spring pressure while allowing adjustment during printing.
12. Place the magazine, lock the magazine.
13. Fasten the spring function lock screw Fig. 7.4 (7) of the adjustment block.

14. See section 7.3, for optimizing the print quality while printing.

7.2 Preparing the control unit

To setup the control unit for the first time:

1. Make sure the system is properly installed and all connections are secured, see sections 6.3, 6.4 and 7.1
2. Connect the mains power plug.
3. Switch on the control unit and wait until the main menu appears.
4. Set the menu language, refer to section 8.6.1.
5. Set the date language, refer to section 8.6.1.
6. Set the time and date, refer to section 8.6.1.
7. Set the interface settings, refer to section 8.6.3.
8. Set the IP address, refer to section 8.6.4.
9. Set the printhead resistance, refer to section 8.6.2.
10. Load a test label, refer to section 9.1.1.
11. Place a substrate between platen and printhead.
12. Touch the test button on the coding unit (make sure the system is paused first).
13. Check whether a print cycle is made (if not check section 9.4).
14. Proceed with the next section, section 7.3.

7.3 Optimising the print quality

The quality of the print is determined by a combination of printhead pressure, print speed, print density (contrast), preheat setting and alignment between printhead and the platen.

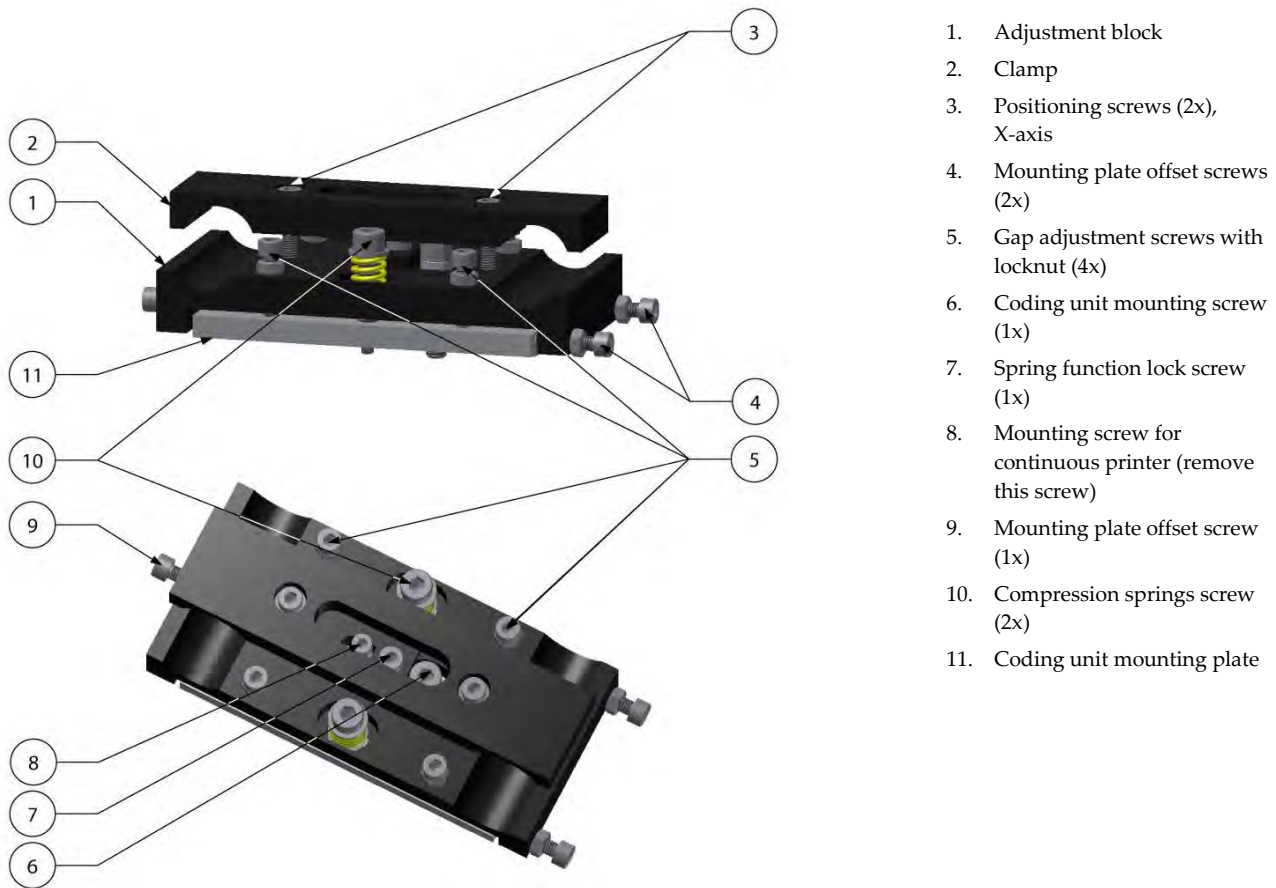

Fig. 7.4 Coding unit adjustment block.

1. Switch on the printer by operating the main switch on the control unit.
2. Set the system operating pressure at 0.4 MPa (0,5 MPa for QiC 107i) using the air regulator.
3. Loosen the spring function lock screw (10).
4. Check whether mounting plate (11) can move freely between the offset screws (4 + 9). If not loosen the offset screw (9).
5. Loosen the lock nuts of the adjustment screws (5).
6. Place and lock the magazine.
7. Load the 'Grid' test label. (refer to section 9.1.1).
8. Set the print density at 10%.
9. Make some prints (when the preheat reached its set temperature) by pressing the test button.
10. When using QiC Draw, download some scope-traces from de printer (via LAN connection). Examine the diagrams for the speed characteristics, the average speed should be around 250mm/sec. Re-adjust the print speed if required by turning the speed adjustment screw in the endblock tension (engineers option).
11. Level the platen out with the print head by turning the four socket-screws (5) until a uniform, good quality print is obtained. The gap between the print head and the substrate should be about 3 mm. If so, the four lock nuts (5) need to be tightened. After tightening the lock nuts, re-adjust by means of either the socket screws or density adjustment if necessary.
12. Examine the print result Fig. 7.5, Fig. 7.6 and Fig. 7.7. If the print is good proceed, otherwise readjust the printer according to the steps above.



Note:

Printing the Grid test label with a low density setting (e.g. 10%) makes it easier to see if the printhead is level with the platen.

13. Set the density at the desired level (probably 60% or above).
14. Tighten the lock nuts on the four adjustment screws after a good print result has been achieved.
15. Fasten the spring function lock screw (7).
16. Check whether the print result is still ok. Repeat the procedure above if required.

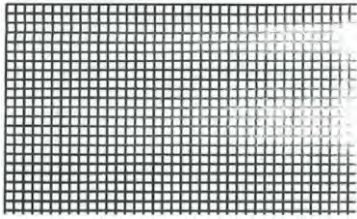

Fig. 7.5 Grid test label printed with incorrect alignment of printhead and platen (density 10%)
(tightening of the adjustment screw at the top right corner will result in a good print)

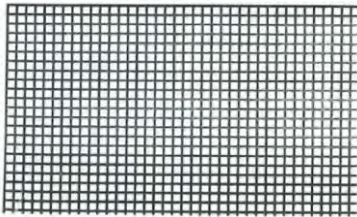

Fig. 7.6 Grid test label printed with correct alignment of printhead and platen (density 10%)

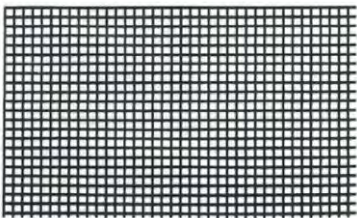

Fig. 7.7 Grid test label printed with correct alignment of printhead and platen (density 60%)

7.4 User settings

Fill out this table with the values found by setting the printer parameters. Use the table, as a reference, to set the printer parameters when the memory is reset to the default values. Alternatively create a Report file, see section 9.2.6 and store it in a place where it can be found if needed e.g. the main label folder on the label design PC.

COMMISSION

Keep the values nearby, when calling the helpdesk of your local distributor.

Printer firmware version:					
QiC control version:					
FPGA version:					
PIC version:					
PX2 OS version:					
Boot version:					
WinCE version:					
WinOS version:					
Parameter	Default value	User setting	Parameter	Default value	User setting
Print delay	5 [ms]		Foil length	450 [m]	
Density	60%		Warning length	25 [m]	
Print quantity	0		PH resistance	1250 [Ohm]	
Debounce	8 [ms]		Pre-Heater	no	
Print queue	0		Temperature	30 [°C]	
Print input	High		Push Home	0 [ms]	
Busy output	High		Printer ID	0	
Alarm output	High		IP address	10.0.1.2xx	
Low Foil output	High		Subnet	255.255.255.0	
Print missed	Error		Gateway	0.0.0.0	
Encoder time-out	Error		Screen rotation	90°	
X-offset	0 [mm]		Start paused	yes	
Y-offset	0 [mm]		System language	English	
Character spacing	0		Date language	English	
Orientation	normal				

Fig. 7.8 Printer parameters, default and user values

Fill out this table and keep nearby, when calling the helpdesk of your local distributor.

Manufacturer host machine, type	
QiC printer model	
Control box, serial number	A
Coding unit, serial number	B
Cassette, serial number	C
Production plant	
Production line	
Type of substrate (product) / Ribbon type	/
Production / print rate	Cycles / min
Ambient temperature (min, max)	°C (min) / °C (max)

Fig. 7.9 Printer environment information

8 OPERATION

This part describes the functions and procedures for operating the printer.

8.1 Powering up

1. Check whether the printer is damaged by visual inspection.
2. Check whether all of the relevant cables are connected.
3. Switch on the control unit.



Note:

When the system parameter *Start paused* is set to *No*, the printer will start printing as soon as the print engine is powered up and a print request is received. The print engine is active before the Main menu is shown. Refer to subsection 8.6.1.



Note:

During the boot process the *Screen calibration* screen will be shown. Do not touch this screen unless the screen calibration of the control unit is incorrect. Refer to section 9.3.

4. Wait until the Main menu is shown.



Fig. 8.1 Main menu

5. Check whether the printer is ready to print, the LED indicators on the coding unit should show a blue light (power on) and a green light (label selected).
6. Access the desired menu function by pressing the appropriate function button.

8.2 Operational

8.2.1 Start printing

1. Check whether the desired label is selected. If not, touch the *Select label* button. Refer to subsection 8.4.1 for more information about how to select a label.

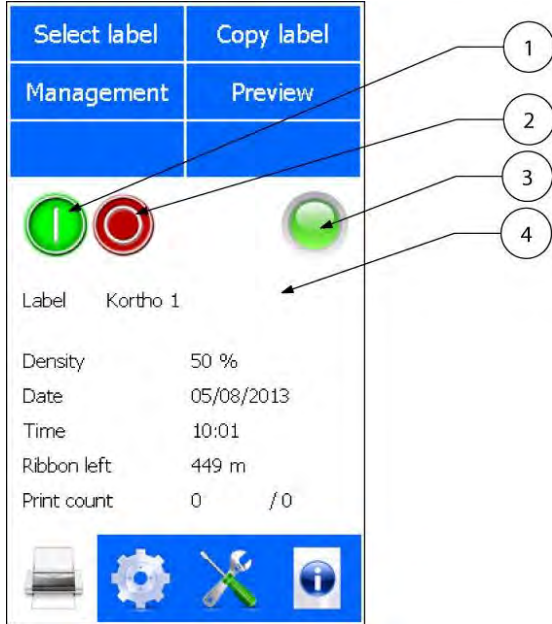

1. Start print (Run mode)
2. Pause print (Pause mode)
3. Indicator LED
4. Label name

Fig. 8.2 Main menu

2. Check whether the *Start print* button is activated, if not touch the *Start print* button to set the printer in the run mode.
3. Apply a print request signal to the printer and the printer will make a print.
4. To pause the printer, touch the *Pause print* button.



Note:

If a print request is received during the pause mode, a popup will appear on screen, showing “Error 44: The printer is paused. Start the print process to continue.”.

8.3 Operator data input

Labels are designed on the PC based design tool QiC Draw, NiceLabel or an alternative Windows based program using the NiceLabel driver, see subsection 2.5. These labels can contain operator input fields, which should be filled out by the operator at the start of the print session.

Refer to subsection 3.4.4 for the available keyboard options.

8.3.1 Text item input menu

The operator input text can be entered using the keyboard. The user prompt text can be set during label design.

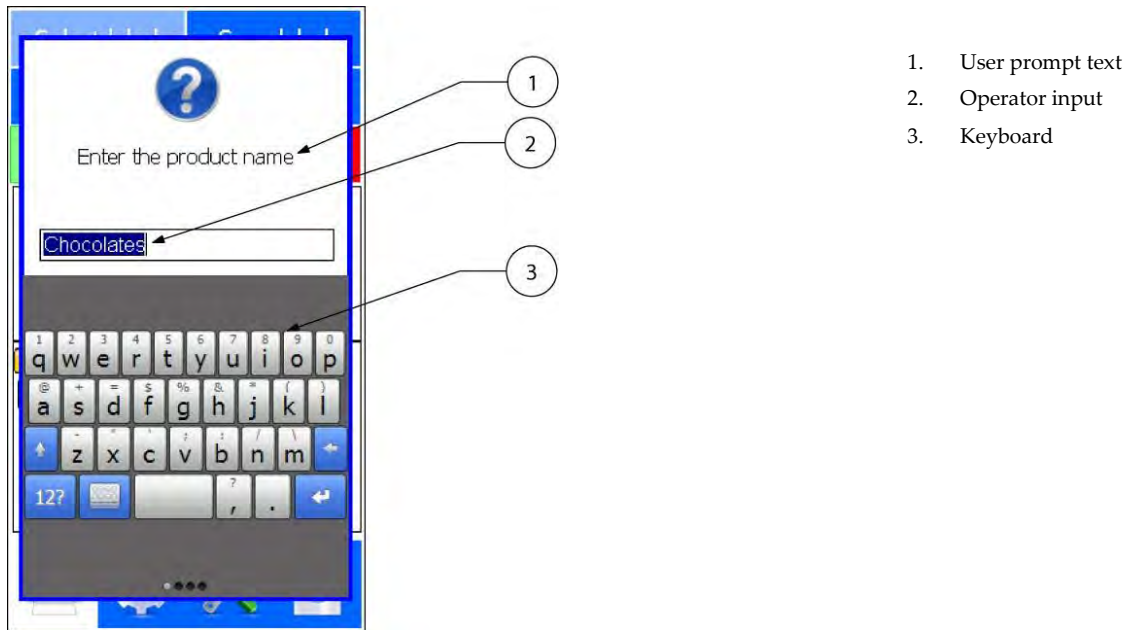

Fig. 8.3 Text item input menu

The use of a user prompt is especially useful if a label has more than one text item that requires changing the contents.

The Operator input shows the text which was used during the previous print run with the selected label or the initial string defined in the label design program. In addition, the length of this string is defined in the label design program. The string, which can contain any mix of characters, can be edited by the operator. One can mark the character(s) which need to be edited and touch the required character(s) that need(s) to replace the old character(s). Alternatively a cursor is indicating the location at which a new character will be inserted.

Use the keys of the keyboard to enter alphanumeric characters. Refer to subsection 3.4.4 for selecting the alternative keyboards.

To edit a string:

1. Touch the Operator input text to select the character(s) that need(s) to be changed.
2. Enter the desired new character(s). The desired character(s) is (are) inserted at the cursor position.
3. Repeat the previous instructions until all the characters have been edited or entered.
4. To delete characters, select the characters that need to be deleted and touch *Backspace*. Alternatively, place the cursor behind the characters that need to be deleted and touch *Backspace* to remove character by character.
5. Touch *Enter* to confirm the Operator input.

8.3.2 Date advance input menu

The offset (advance) of a date code can also be entered using an operator input. The User prompt text can be set during the label design.

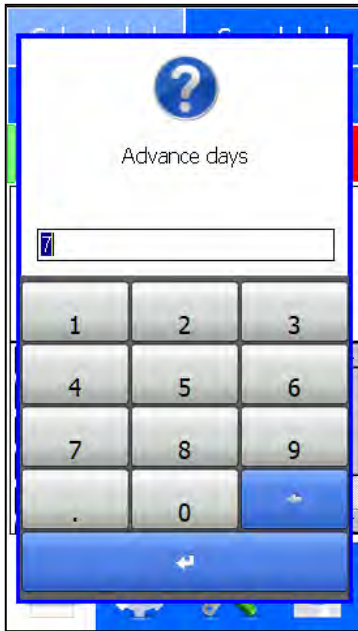

Fig. 8.4 Date advance input menu

The date field, which can be edited by the operator, accepts only valid inputs. The digit that can be edited is marked with a cursor beneath it.

To enter a complete new value:

1. Enter the desired new offset.
2. Touch *Enter* to confirm the Operator input.

To change only a few numbers:

1. Touch the Input text to select the digit(s) that need(s) to be changed.
2. Enter the desired new digit(s). The desired digit(s) is (are) inserted at the cursor position.
3. Repeat the previous instructions until all the digit(s) have been edited or entered.
4. To delete digits, select the digits that need to be deleted and touch *Backspace*. Alternatively, place the cursor behind the digits that need to be deleted and touch *Backspace* to remove the text digit by digit.
5. Touch *Enter* to confirm the Operator input.

8.3.3 Number start value input menu

The number displayed on screen is the last value entered on the system by the operator. The very first time the label is selected, it will show the start value entered in the label design software.

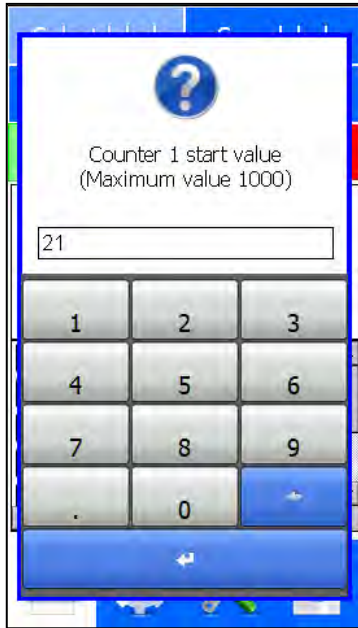

Fig. 8.5 Number start value input menu

The number field shows the last entered value used at a previous print run with this label or the initial value defined by the label design program.

The number field, which can be edited by the operator, only accepts valid numbers as defined by the label design program.

To enter a complete new value:

1. Enter the desired new digit(s).
2. Touch *Enter* to confirm the Operator input.

To change only a few characters:

1. Touch the Input text to select the digit(s) that needs to be changed.
2. Enter the desired new digit(s). The desired digit(s) is (are) inserted at the cursor position.
3. Repeat the previous instructions until all the digits have been edited or entered.
4. To delete (a) digit(s), select the digit(s) that need to be deleted and touch *Backspace*. Alternatively, place the cursor behind the digit(s) that need to be deleted and touch *Backspace* to remove the text digit by digit.
5. Touch *Enter* to confirm the Operator input.

8.4 Label management

8.4.1 Selecting a label for printing

To select a label from the label memory:

1. Touch the *Select label* button. The contents of the label memory is displayed and a further two buttons will appear, *Select* and *Cancel*.

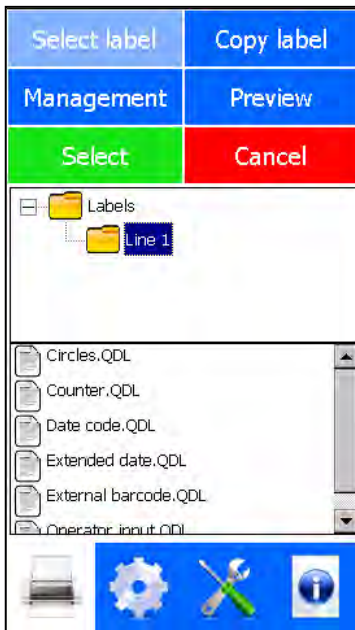

Fig. 8.6 Select label menu

2. Touch a folder and alternatively its sub-folder in the upper window to make the label files appear in the lower window.
3. Touch the label that needs to be printed.
4. Touch the *Select* button.

The green LED will light up on the coding unit and the printhead will move backwards and forwards to check the encoders.

5. The operator input screen will appear if the label selected requires the input of data, see section 8.3.
6. Enter the required data and touch *Enter*, the system will return to the Main screen.
7. Touching the *Preview* button will show a preview of the label that will be printed, see also section 8.4.5.

8.4.2 Transferring labels to the control unit

To transfer labels to the control unit first insert a USB thumbdrive containing one or more labels and/or label directories and wait for around 3 seconds (for USB thumbdrive with a LED: wait until the LED flashes).



CAUTION:

Do not use an extension cable for connecting the USB thumbdrive to the control unit, but place the USB thumbdrive directly in the control unit. Using an extension cable can cause EMC interference.

1. Touch the *Copy label* button. The contents of the label memory is displayed and a further two buttons will appear, *Copy* and *Cancel*.

OPERATION

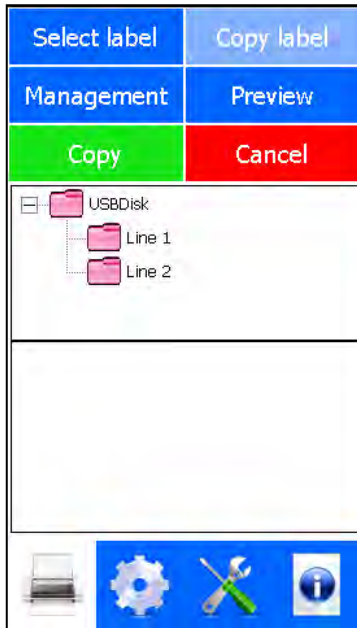

Fig. 8.7 Copy label menu, USB thumbdrive



Note:

The directories that are stored on the USB thumbdrive are shown in pink, while the directories that are stored in the label memory are shown in yellow.

2. Touch a folder or one of its sub-folders in the upper window to make the label files appear in the lower window.
3. Touch the sub-folder or file in the lower window that needs to be copied.
4. Touch the green *Copy* button.
5. The screen will switch to the explorer screen of the label memory.

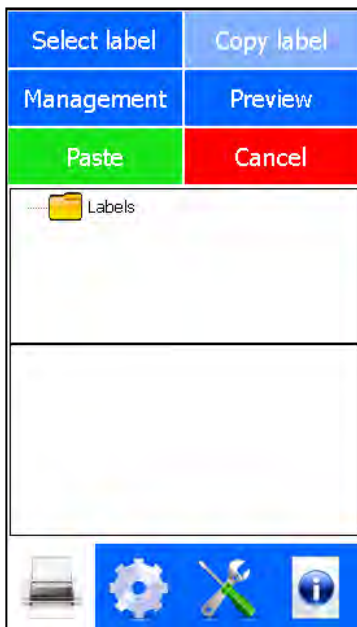

Fig. 8.8 Copy label menu, label memory

6. Touch the label folder to which the labels need to be copied to (The printer initially has one folder called Labels).
7. Select the *Paste* button. The selected USB thumbdrive labels will now be copied to the control unit.
8. If a label name already exists in the label memory the Overwrite label message will appear on screen.



Fig. 8.9 Overwriting label message

9. Touch *Yes* and the label will be overwritten.
10. Touch *No* and the Paste operation will be cancelled.
11. If copying of a label fails, the Copy label failed message will appear on screen. Touch *Ok* to return to the Main menu.



Fig. 8.10 Copy label(s) failed message

12. When there is not enough memory available for the labels to be copied, an insufficient memory message appears on screen. Copying 'new' labels is only possible when some 'old' labels are deleted or the memory is cleared. Refer to the next subsections 8.4.4.



Fig. 8.11 Insufficient memory message

13. The copy procedure is now finished.

8.4.3 Moving a label

There is a Move function available to make it possible to rearrange the label files and directories.

1. Select *Management* in the Main menu.

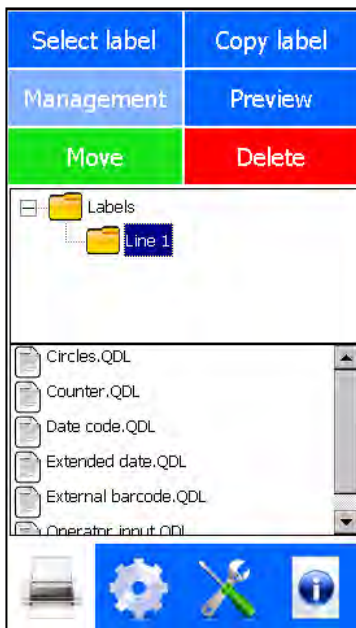

Fig. 8.12 Move label menu

2. Touch the label file or folder which needs to be moved in the lower window.
3. Touch *Move*, the following screen will appear.

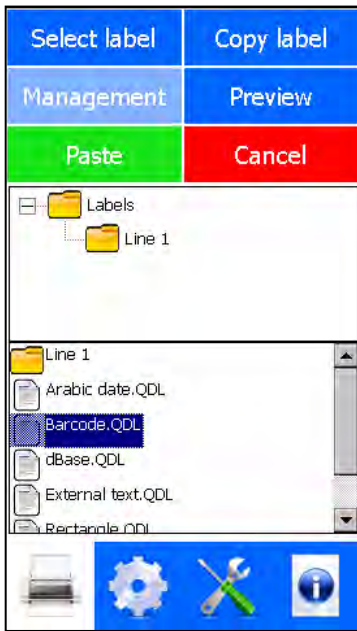

Fig. 8.13 Paste label menu

4. Touch the folder to which the label or folder label file needs to be moved to (upper window).
5. Touch the *Paste* button.
6. The Move procedure is now finished.

8.4.4 Deleting a label

There is a Delete function available to make it possible to remove label files and/or folders.

1. Select *Management* in the Main menu.

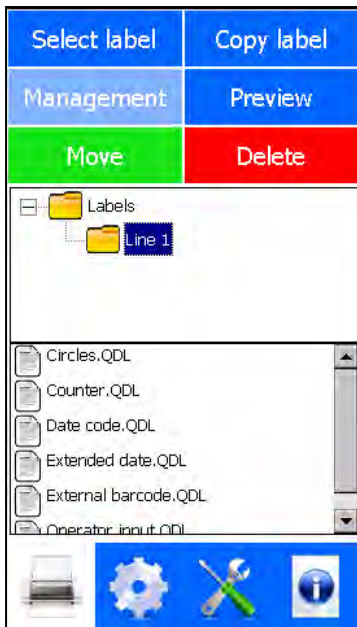

Fig. 8.14 Delete label menu

2. Touch the label file or folder that needs to be deleted in the lower window.
3. Touch *Delete*, the following screen will appear.



Fig. 8.15 Delete label message

4. If the label or folder really needs to be deleted, confirm this by pressing *Yes*.
5. If the label or folder does not need to be deleted, touch *No* to cancel the operation.

8.4.5 Showing a preview

There is a Preview function available that will show the currently printed label on screen.

1. Select *Preview* in the Main menu, the first preview screen will show a 1:8 picture.

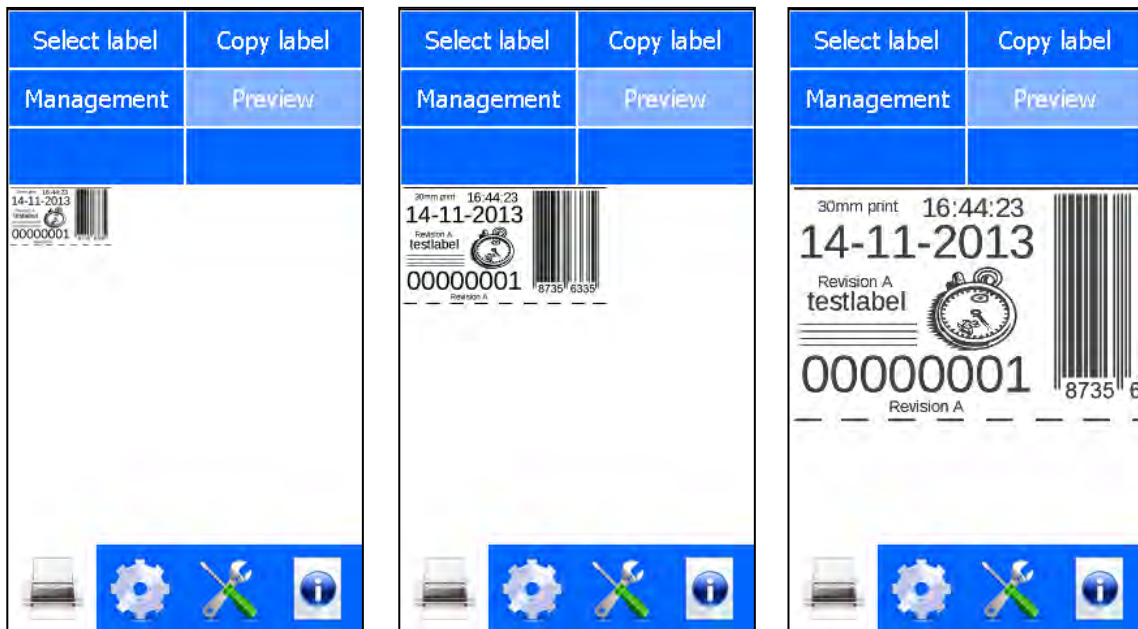

Fig. 8.16 Preview screen

8. Touch *Preview* again to show a 1:4 picture;
9. Touch *Preview* again to show a 1:2 picture.

When the label is larger than the screen, one can use the touchscreen to drag the preview around.

8.5 Magazine handling

8.5.1 Removing the magazine

1. Push the handle inwards and move the handle in a clockwise direction until the handle faces 9 o'clock.



Note:

The status LED will turn orange.



Fig. 8.17 Unlock magazine

2. Use both hands and pull on the magazine handles with equal force to remove the magazine.



CAUTION:

Do not place any your fingers in the opening in the main plate of the coding unit once the magazine has been removed. This as there is a small change one cuts oneself on sharp edges on parts inside the coding unit and there is a very small change one becomes trapped due to moving parts inside the coding unit.

8.5.2 Placing the magazine

1. Align the magazine guide posts with the guide tubes mounted on the printer and slide the magazine to its home position until it is fully engaged with the printer body.



Fig. 8.18 Lock magazine

2. Push in the handle and turn in an anti-clockwise direction until positioned at 6 o'clock.
3. Push the front button (S) to reset the printer.
4. Check whether all LEDS are system ready (Status LED Green, Power LED blue).
5. If not paused, set the system in pause mode.
6. Make a test print by pushing the button again.
7. Set the system in run mode, the printer is now ready for printing.

8.5.3 (Re)placing ribbon

1. Pause the printer process.
2. Remove the magazine, see section 8.5.1.
3. Remove the used ribbon and empty core.
4. Re-use the empty core on the take-up spool.
5. Clean the ribbon sensor roller with a lint free wipe soaked in isopropanol.

**CAUTION:**

Always follow the Safety guidelines presented in the SDS of the cleaning solution used.

6. Clean the magnets of the encoder sensor in the coding unit with a lint free wipe soaked in and isopropanol.
7. Place new ribbon roll onto the feed spool and direct the ribbon along the path shown in the diagram, see Fig. 8.19.
8. Tape the ribbon on the empty take-up core (a new roll of ribbon has an adhesive part at the beginning of the ribbon).

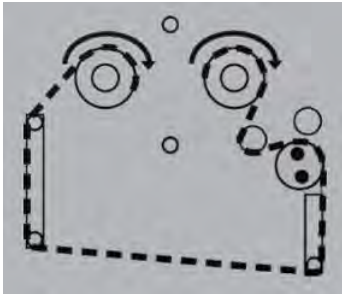

Fig. 8.19 Ribbon path

9. Tension the ribbon by turning the empty take-up spool clockwise a few turns to wind up some ribbon.
10. Place the magazine back and press the front button (S) to get the system operational again, see section 8.5.2.
11. Press and hold the front button for about 4 seconds to reset the ribbon left value to the length of a full roll (the reset procedure is completed when the LED flashes green/orange).
12. The printer is now ready for printing.

8.6 Adjusting printer settings

1. Touch the *Settings* icon located at the bottom of the screen. The following status screen is shown.



Fig. 8.20 Settings menu

8.6.1 System settings

1. To change the system settings touch the *System* button at the top of the screen.

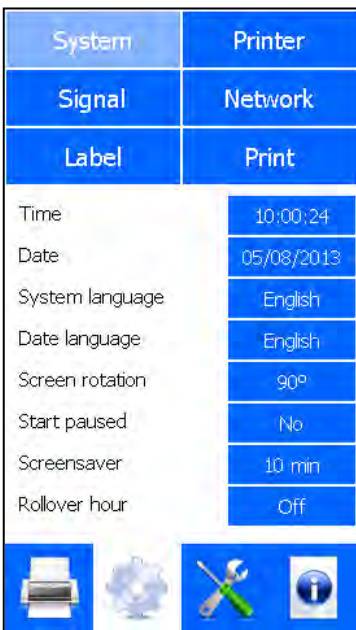

Fig. 8.21 System settings menu

Time and/or Date

1. Touch the blue button that shows *Time* or *Date*.

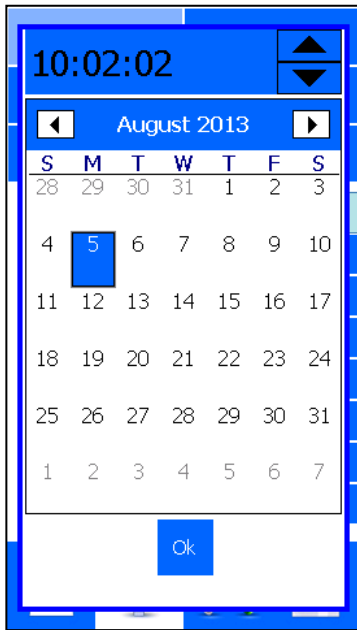

Fig. 8.22 Date and Time menu

2. Touch the item that needs changing, e.g. hours, minutes or seconds.
3. Touch the arrow up or arrow down to adjust the time.
4. Touch the arrow left or arrow right to change the month and year.
5. Touch the day of the month to change the selected date.
6. Touch *Ok* to confirm and store the new settings.

System language

1. Touch the blue button that shows System language.

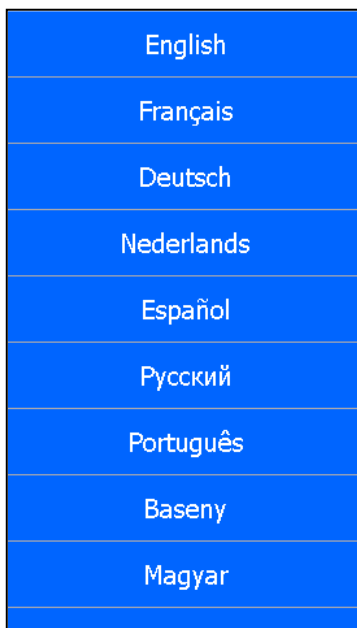

Fig. 8.23 System language selection menu

2. Touch the language button to select another language.

**Note:**

When there are more languages than fit on screen, one can touch the screen and drag up and downwards to select the required language.

3. The system will ask if it should reboot.

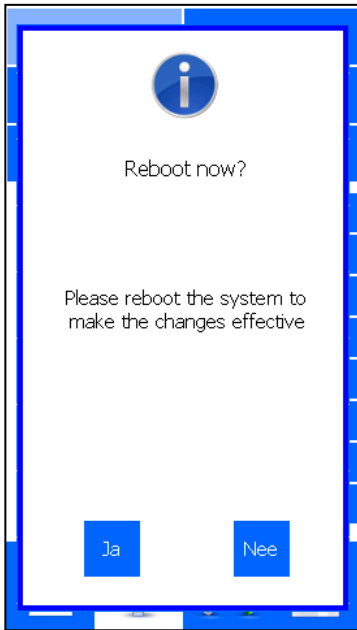

Fig. 8.24 Reboot message screen

4. Touch *Yes* to set the new language immediately. The graphical interface will reboot, but this does not affect the printing process.
5. Touch *No* if:
 - a. The wrong language has been selected. Select the correct language immediately after aborting the system reboot procedure.
 - b. The new language must not be applied immediately, but on next boot up.

Date language

The language set as Date language is used to print the Months and Day of the week (e.g. when set to English: Monday, Mon, January, Jan. When set to Dutch: Maandag, Maa, Januari, Jan).

1. Touch the *Date language* button.

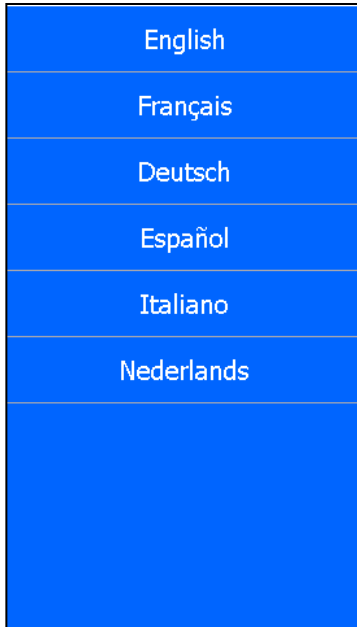

Fig. 8.25 Date Language selection menu

2. Touch the language button to select another language.

Screen orientation

1. Touch the blue button that shows *Screen orientation*.



Fig. 8.26 Screen orientation selection menu

2. Touch the desired screen orientation.
3. The system will ask if it should reboot.

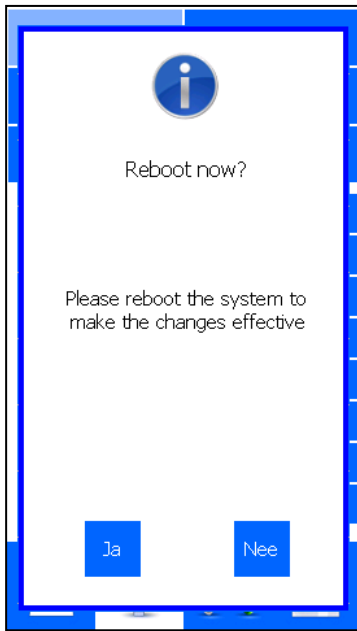

Fig. 8.27 Reboot message screen

4. Touch *Yes* to set the new screen orientation.
5. Touch *No* if:
 - a. The wrong screen orientation has been selected. Select the correct screen orientation immediately after aborting the system reboot procedure.
 - b. The new screen orientation does not need to be applied immediately, but on next boot up.

Start paused

1. Touch the blue button that shows *Start paused* to change the setting from *No* to *Yes* or from *Yes* to *No*.

When *Yes* is selected the printer will boot in pause mode. While in pause mode the printer will ignore print request signals applied. In order to start the print process the operator should touch the start print button.

When *No* is selected the printer will boot in run mode. The printer will immediately make a print when the print processor is ready to start the print process and a print request signal is applied.



Note:

The print engine is ready to print before user interface has completely booted. As soon as the print engine is ready the printer will make a print as soon as a print request signal is applied.

Screensaver

1. Touch the blue button that shows *Screensaver*.

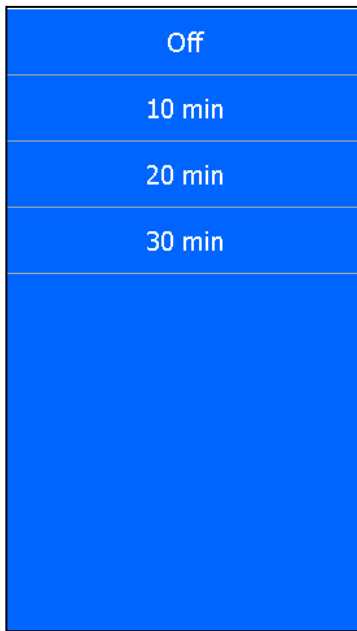

Fig. 8.28 Screensaver selection menu

2. Select the period of time after which the screen save mode must become active, when the screen is not touched.

The printer will continue to function normal while the screen save mode is active. After touching the screen it will be powered on again.

Rollover hour

1. Touch the blue button that shows *Rollover hour* to change the hour at which the printed date needs to turn over to the next day.

The default setting is Off, which means the date will turn over to the next day at 24:00. If e.g. the date needs to change at 03:00 the Rollover hour needs to be set to 3.

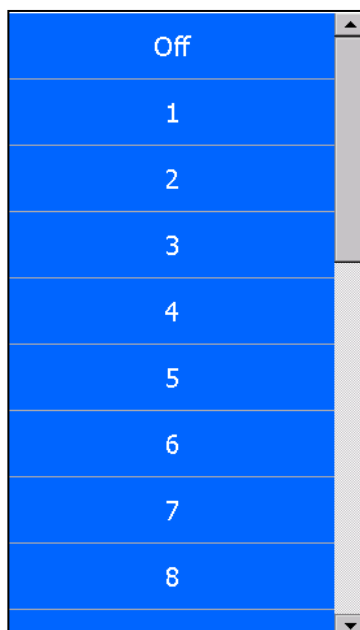

Fig. 8.29 Rollover hour selection menu

8.6.2 Printer settings

To change the printer settings touch the *Printer* button.

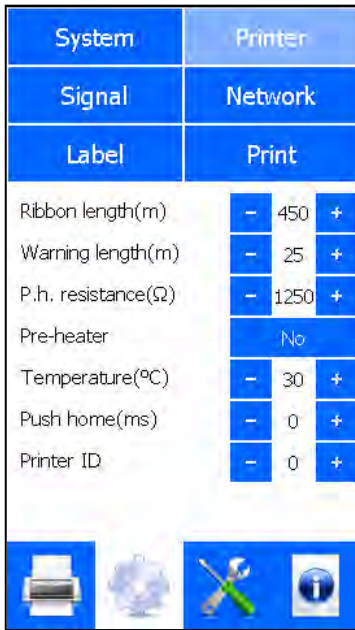

Fig. 8.30 System settings menu

Changing the printer settings

To change numeric settings:

1. Touch the + / - buttons, or
2. Touch the value shown to enter it from the numerical keyboard.

To change selectable settings:

1. Touch the button and the setting will change (toggle function), or
2. When touching the button a list of choices will appear from which the required setting can be selected.

Ribbon length

It is important to set this value to correctly show the length of unused ribbon that is left on the printer magazine so that the system can warn the operator when the ribbon is almost used up. See section 9.1.6.

Warning length

This value (metres ribbon left) determines when the system will create a “low ribbon” warning indication. A message will be shown on screen and the orange LED on the coding unit will flash to indicate this.

Print head resistance

It is important to set this value to reflect the resistance of the currently fitted print head. The resistance is noted on the serial label of the printhead. The value is always between 1000 and 1500Ohm.



CAUTION:

If the print head resistance is set incorrectly the print head can be damaged resulting in a poor print quality or no print at all.

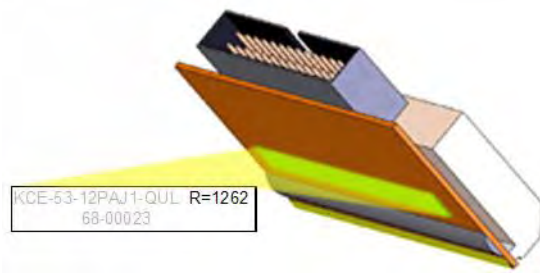

Fig. 8.31 Print head resistance

Pre-heater

This setting should be used to switch the pre-heat function on or off. The preheat function is used to regulate the temperature of the printhead to ensure optimum print quality. It is recommended that the Pre-heater setting be set to *Yes* when the temperature inside the building, in which the printer is used, is below 20°C or when the substrate is hard to print on. When *Yes* is selected a green LED will light on the control unit when power is supplied to the heating element. Set the temperature using the *Temperature* setting.

Temperature

See Pre-heater above. Depending on the print quality the value must be adjusted to the optimal value. The range is 25°C to 45°C. Refer to section 7.3.

Push home

It is only necessary for this value to be set when the printer is mounted vertically printing downwards. Due to vibrations there is a chance that the printhead will slowly move downwards (out of its home position) at that time.

When this function is activated, the print head carriage is pushed back into the home position before each print. One can set the time the carriage is pushed back in milliseconds. Generally this variable will be set by the service engineer when the printer is installed. The setting range is 0 to 550ms, when set to 0 the function is de-activated.



Note:

Using this option will decrease the number of prints per minute (PPM) because it takes time to push the printhead carriage back into the home position. Once the carriage is pushed back for the set amount of milliseconds, the system will make the print.

Printer ID

This is a number from 0-255 that can be used to identify the printer. The printer ID can be used in the label design and can in this way be printed on the substrate.

8.6.3 Signal settings

To change the signal settings touch the *Signal* button.



CAUTION:

These settings will be set during installation; only a trained engineer should change them.

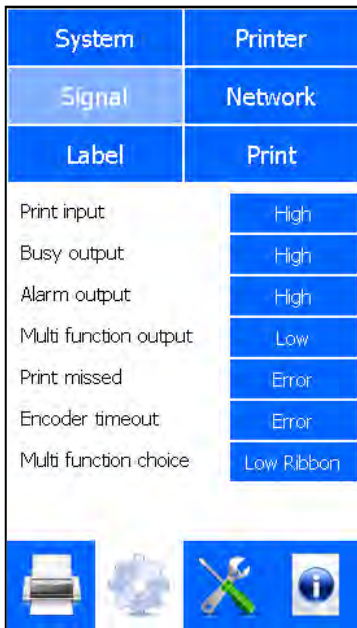

Fig. 8.32 Signal settings menu

Changing the signal settings

To change numeric settings:

1. Touch the + / - buttons, or
2. Touch the value shown to enter it from the numerical keyboard.

To change selectable settings:

1. Touch the button and the setting will change (toggle function), or
2. When touching the button a list of choices will appear from which the required setting can be selected.

Print input

Select the rising edge or falling edge of the product detection sensor. This setting depends on which type of sensor is used and how it is set.

Usually, the sensor is set in a way that the print will be made on the rising edge. Default setting is High (rising edge).

Busy output

This output signal tells the host machine that the printer is busy printing and that the substrate should not move. This signal can be leading (High) or falling (Low) edge synchronised.

This signal is active from the moment the thermal printhead is going down until it is going up again. So, the period that the thermal printhead is in contact with the substrate.

Alarm output

The output signal tells the host machine that an error has occurred which requires user attention. This signal can be set to be active high or active low.

Multi function output

Set this to correspond to the required output level when the output is active. This signal can be set to be active high or active low. The function of the Multi function output is set by the Multi function choice.

Print missed

This signal is activated when the printer receives a print signal while it the previous print cycle is still in progress.

This parameter can be set to *Error* or *Warning*. When set to *Error* a missed print will abort the printing process and the general alarm will be set. When set to *Warning*, the print process will continue when a missed print is detected, a warning will be displayed on screen and depending on the *Multi function choice* setting, see below, the Warning output will be activated for 50ms (pulse).

Encoder timeout

This parameter can be set to *Error* or *Warning*. When set to *Error*, an encoder timeout will abort the printing process and the general alarm will be set. When set to *Warning*, printing will continue and a warning will be displayed on screen and depending on the *Multi function choice* setting, see below, the Warning output will be activated for 50ms (pulse).

Multi function choice

This parameter can be set to *Low Ribbon* if this output is used to indicate low ribbon on the printer. Alternatively it can be set to *Warning* if the system should use the output to indicate that a warning has occurred. At that time the output will generate a 50ms (pulse).

When set to *Warning* the multi function output can e.g. be used to trigger an external device that removes the non-coded product from the production line.

8.6.4 Network settings

These settings make sure the system can be reached over the internal network and that communication between e.g. PC (label design) and printer can take place.

To make sure the settings will match the network settings, always talk to the network administrator for help integrating the printer into the company network.

Touch the *Network* button to open network settings menu.

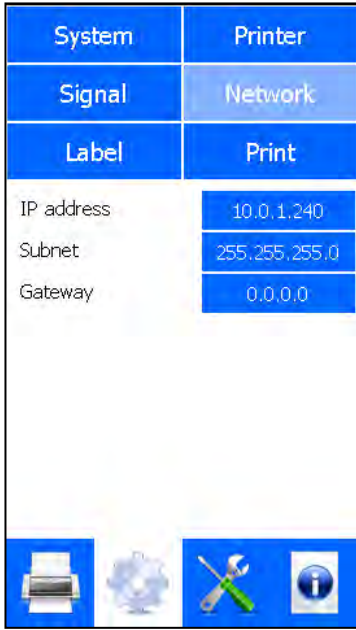

Fig. 8.33 Network settings menu

IP Address, Subnet and Gateway

1. Touch the corresponding blue button and the following screen will appear.



Fig. 8.34 Network settings, IP address

2. Enter the desired value (do not forget to enter the decimal points).
3. Confirm with *Enter*.
4. Reboot the system to activate the new network settings.

When one doesn't reboot the system immediately, the old settings will remain active until the next boot-up.

8.6.5 Label settings

To change the label settings of the printer touch the *Label* button.



Fig. 8.35 Label settings menu

Changing the label settings

To change numeric settings:

1. Touch the + / - buttons, or
2. Touch the value shown to enter it from the numerical keyboard.

To change selectable settings:

1. Touch the button and the setting will change (toggle function), or
2. When touching the button a list with choices will appear from which the required setting can be selected.

X-Offset and Y-Offset

The label can be moved along the X-axis and/or the Y-axis of the printer. X is along the print head and Y is in the print direction. Changing the settings will move the label printed on the product in the corresponding direction. The offsets are entered in mm.



CAUTION:

If the label is offset too much one could lose parts of the print. To prevent the most common issues, the system will perform a check on the Y-offset.

- When a new label is loaded: the system will check whether the new label will be completely printed with current Y-offset. If not the Y-offset will be reset to 0.
- When the Y-offset is changed: the system will check whether the current label will be completely printed with the new Y-offset. If not the system will show a warning telling the Y-offset value is too high.

Character spacing

The distance between the characters in a text can be enlarged (inter character spacing). All text in a label is altered by this value. The units are 1/12 mm. Re-select the label to effectuate this change.

Label orientation

The orientation of the label to be printed can be changed in the firmware of the printer.

1. Touch the *Orientation* button.



Fig. 8.36 Orientation setting selection

2. Select the required orientation.

Mirror flips the printed label along the width of the print head. *180°* rotates the label 180 degrees around the centre of the print head. *Mirror / 180°* combines the other two rotations.

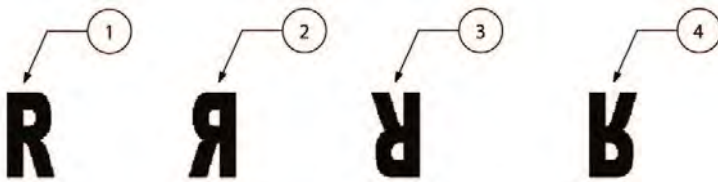

1. Normal
2. Mirror
3. 180°
4. Mirror + 180°

Fig. 8.37 Orientation setting

8.6.6 Print settings

To change the print settings of the printer touch the *Print* button.

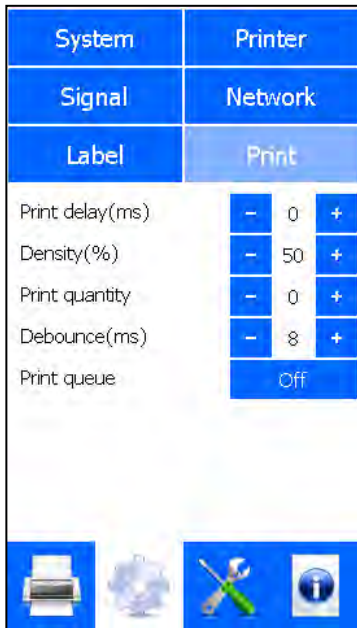

Fig. 8.38 Print settings menu

Changing the print settings

To change numeric settings:

1. Touch the + / - buttons, or
2. Touch the value shown to enter it from the numerical keyboard.

To change selectable settings:

1. Touch the button and the setting will change (toggle function), or
2. When touching the button a list with choices will appear from which the required setting can be selected.

Print delay

This value sets the delay. Delay is the time, set in milliseconds, which the system will wait after receiving a print request before making the actual print.

On most host machines the print request signal is applied at the end of the machine cycle, so just at the moment the substrate movement stops. Because of the machine dynamics the substrate quite often moves a bit backwards and forwards after that. This means that the printer will start printing while the substrate is still moving. To prevent this the *Print delay* can be set.

Density

This value varies the amount of energy applied to the thermal printhead and therefore the amount of heat that is applied to the ribbon. It is required to set the density for each individual application (combination of e.g. substrate, ribbon, temperature, humidity) to get the best print quality possible.



CAUTION:

If not enough heat is applied to the ribbon, the pigment that makes up the printed label may not adhere correctly to the product. If too much heat is applied to the ribbon it may not adhere correctly or potentially the print head could be damaged.

**CAUTION:**

Always use the lowest density setting possible, this as the lifetime of the printhead will be influenced by the density setting.

Print quantity

This value sets the number of labels to print. When the set value has been reached, the printer will stop the printing process and the General alarm output will be activated to indicate that the batch is complete. When set to zero the current label will print indefinitely.

Debounce

The debounce time is the time a print request signal needs to be active to be regarded as a valid print request. A shorter signal is considered to be noise and will not result in a print. The unit are milliseconds.

Print queue

Set this to *On* if a print request signal that's coming in during a printcycle need to be queued. When set to *Off* a print request signal that's coming in during a printcycle will set the Print missed error/warning.

Print queue means that a print request is put in the queue when the system is busy making a print. The print queue can store 1 print request.

**Note:**

When the print queue contains a print request, this print request will be executed directly after the current print has been made. When multiple print requests come in during a print cycle, only 1 will be stored in the print queue. The others are simply disregarded. This in turn implies that the Print missed error or warning is not active when the print queue is activated.

**CAUTION:**

If a print request is received during the current print cycle, the system will make a print right after the current print has been made. When the substrate has not moved, it will place the print directly over the previous print. If the substrate normally starts moving after a print, the system will attempt to make a print on the substrate which could be moving. In that case, the possibility exists that the substrate will break, the ribbon will break or other errors will occur.

9 DIAGNOSTICS / TROUBLESHOOTING

For fault finding and problem solving a wide range of information screens and diagnostics functions is available in the system. Alternatively the Service module inside QiC Draw can be used.

9.1 Diagnostics

Touch the *Diagnostics* icon located at the bottom of the screen. The following status screen is shown.



Fig. 9.1 Diagnostics menu



Beware:

Many of the features in this section only work when the printer is paused. Pause the printer by pressing the *Pause* icon. When paused the *Pause* icon is brightly lit.

9.1.1 Test labels

For diagnostic reasons and for setting up the printer two test labels are factory programmed. These labels cannot be deleted from the system. To select a test label:

1. Touch the *Test Labels* button.

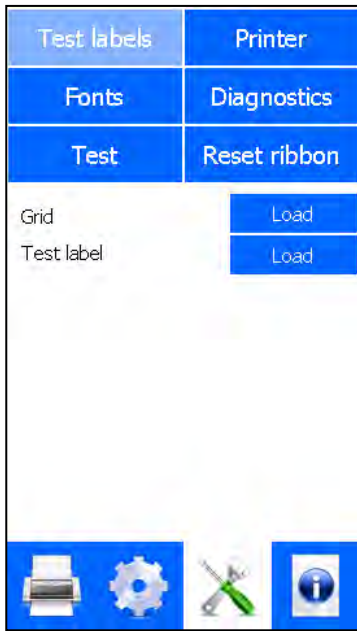

Fig. 9.2 Test label menu

2. Touch either of the *Load* buttons to load a test label. *Grid* loads a grid pattern test label and *Test label* loads a Kortho test label containing items like text, date, number and barcode.
3. The Test label loaded message will be displayed on screen.

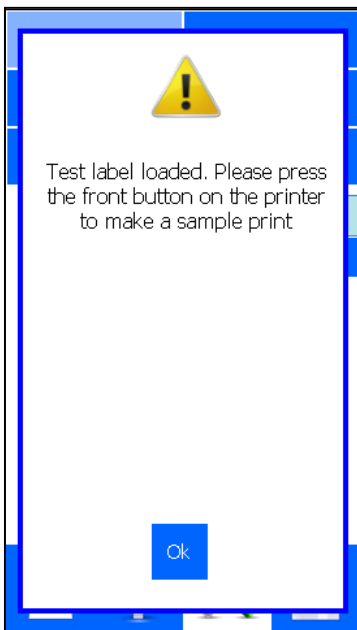

Fig. 9.3 Test label loaded

4. Press the front button (S) on the coding unit briefly to make a print. A sample print can also be made by using the Diagnostics Test function (see section 9.1.5).



Beware:

The Test label will remain selected until a new label is selected or the system is switched off and on again. Make sure another label is selected when starting up the production, otherwise the Test label will be printed during production.

9.1.2 Printer

Touch the *Printer* button to open the Printer menu.

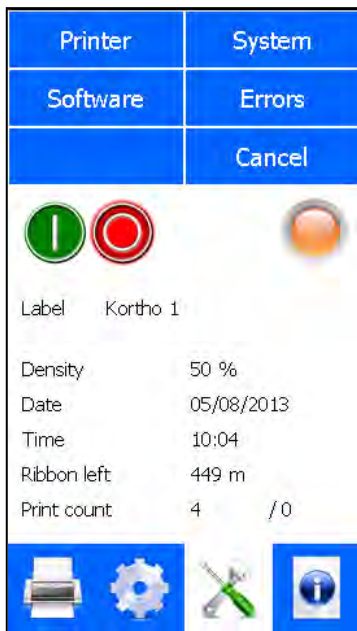

Fig. 9.4 Printer main menu

Printer

Touch the *Printer* button to show some diagnostic values of the printer.

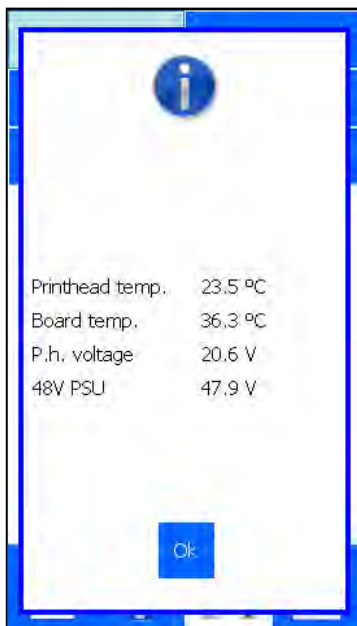

Fig. 9.5 Printer diagnostics screen

Printhead temperature - the ideal printing temperature is around 30°C.

Board temperature – the temperature of the main board that's located in the control unit. It is measured by a sensor on the main board.

Head voltage – indicates the voltage applied to the printhead. This printhead drive voltage is generated by a formula that contains the density setting and printhead resistance.

48V PSU – indicates the voltage supplied by the 48V power supply.

System

Touch the *System* button to show the information about the system.

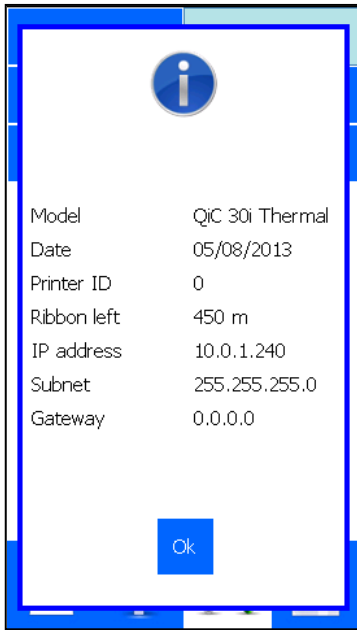

Fig. 9.6 System information screen

Model – model of the printer connected to the control unit.

Date – system date of the control unit.

Printer ID – the printer ID as defined by the user.

Ribbon left - the length of remaining ribbon on the magazine, measured in metres.

IP Address/Subnet/Gateway – the set network addresses of the control unit.

Software

Touch the *Software* button to show the installed firmware and software versions.

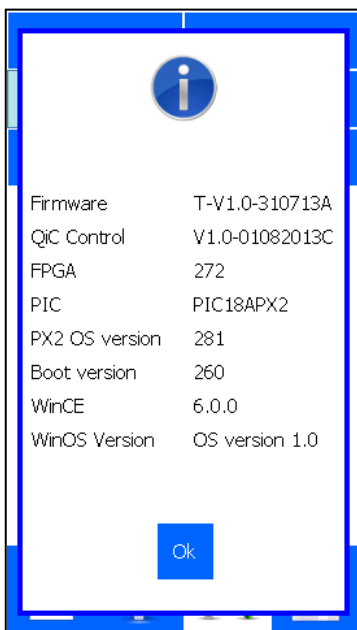

Fig. 9.7 Software and firmware version screen.

Firmware – the firmware that controls the main board.

QiC Control – the software that creates the user interface.

FPGA – the software that handles numerous functions in the system e.g. the printhead data.

PIC – the software that handles the timing and temperature of the printhead.

PX2 OS version – operating system of the main board.

Boot version – the software that makes it possible to upgrade the system through the Ethernet connection.

WinCE – the software version of the Windows CE version running on the user interface hardware.

WinOS Version - the build version of the image that is used to flash the user interface hardware.

Error

Touch the Error button to show the 10 most recent errors/warnings since the printer was switched on.



Beware:

When the control unit is rebooted or switched off the error list will be cleared.



Note:

To view errors 4 to 10 touch the screen and drag the messages upwards. This will scroll them into view.



Note:

If an error occurs more than once, sequentially, the error will only be displayed once. The amount of times an error has occurred sequentially will be mentioned between brackets, e.g. see Error 5 in Fig. 9.8.

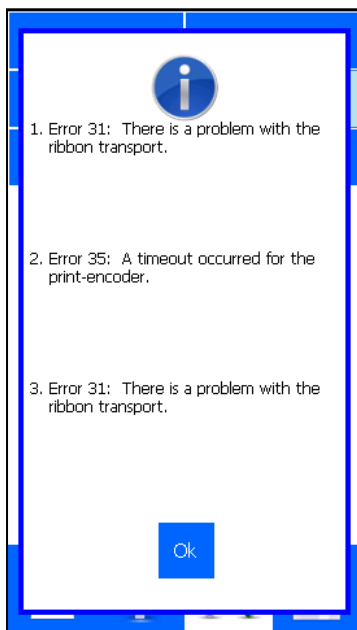

A

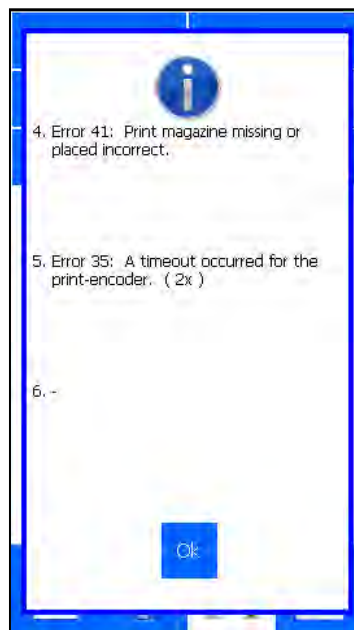

B

Fig. 9.8 Error-Warning list

Touch the *Ok* button to return to the Diagnostics menu.

9.1.3 Fonts

Touch *Fonts* to display the list of fonts which are installed in the printer.



Beware:

The font list must match the font list in the label design program used to design the labels. If a non-installed font is used in the label as internal font the printer will not be printed at all. Due to this the printed label will miss one or more items. In the worst case the label will not be printed at all and a range of error messages can come up e.g. font error and no label loaded.



Fig. 9.9 Font list screen



Note:

The printer is supplied with a set of internal fonts installed. The fonts shown in the picture above are the pre-installed fonts. These fonts can be replaced by other fonts using QiC Draw.

The fonts shown on screen are those that should be used when using auto code variables inside labels. Auto codes are variables that can change between prints – e.g. date, time and counters.



Beware:

The pre-installed Arabic font may only be used for printing digits, e.g. for time, date and number items. As not all alphanumeric characters are available in the font, using the font for text will lead to characters not being printed.

9.1.4 Diagnostics

Touch *Diagnostics* to enter the diagnostics menu in which various system checks can be performed.



Beware:

System Diagnostics should only be run when the system is paused. Often the tests require that the system air supply is attached. Only a trained service engineer should run these tests.

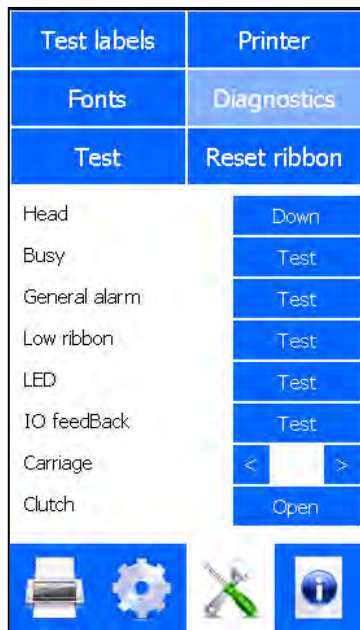

Fig. 9.10 Diagnostics menu

Head - The head valve is activated for 2 seconds so the thermal head is driven downwards for 2 seconds. This can be used to test whether this assembly works fine.

Busy – The busy output is activated for 2 seconds. This can be used to test whether the busy output is functioning. The output can be monitored on the host machine or a separate service tool.

General alarm - The General error output is activated for 2 seconds. This can be used to test whether the general alarm output is functioning. The output can be monitored on the host machine or a separate service tool.

Low Ribbon – The low ribbon/warning output is activated for 2 seconds. This can be used to test whether the Low Ribbon output is functioning. The output can be monitored on the host machine or a separate service tool.

LED - The printhead tri-colour LED is cycled through its colours: green, red and orange. This can be used to test whether the tri-colour LED is intact.

IO Feedback - This button is used to test the most important internal (Carriage encoder, Ribbon encoder, Magazine latch and Front button) and external inputs (Print request signal, Trigger, Remote front button and spare input of the control unit).

The internal inputs can be tested by activating these by following this method:

1. Magazine latch. Open and close the lever that unlocks the magazine and touch *IO feedback*.
2. Front button, carriage encoder and ribbon encoder. Press the front button (S). A print is made. Touching *IO feedback* should indicate *Yes* to these three items.



Note:

Since the front button and both encoders are located in the coding unit, the possible problem could also be in the wiring to the control unit or a defective front button switch or encoder device.

The external inputs can be checked using a service tool or attached peripheral device. To test the external inputs:

1. Select *IO Feedback* and activate the attached peripheral device (sensor or other device) or
2. Use a service device to activate the inputs.

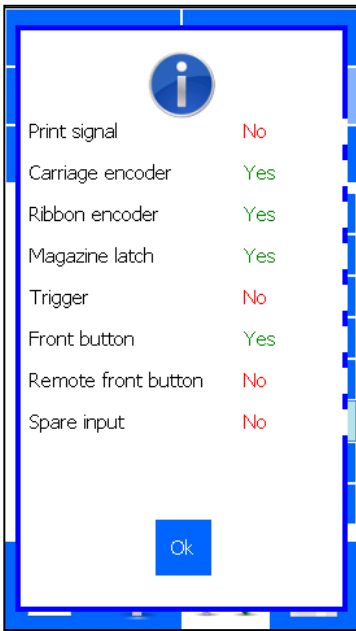

Fig. 9.11 IO feedback screen

Carriage - The carriage is moved forward when < is pressed and backwards when > is pressed. This can be used to test whether the valves that drive the carriage are operational and if the carriage "moves" properly.

Clutch - The clutch valve is activated for 2 seconds. This can be used to test whether the clutch solenoid is operational and whether the actual clutch does indeed open and close (releases / engages).

9.1.5 Test

This function can be used to make test prints to verify and to optimize the print quality. This can be done with the current label but it is better to use a *Test label*, see section 9.1.1.

Touch *Test* to enter the menu that contains the print test functions.

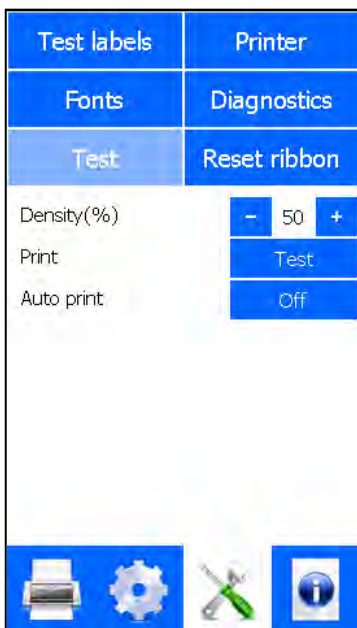

Fig. 9.12 Test menu

Density - Touch +/- to alter the contrast or heat applied to ribbon. Alternatively touch the value shown and enter the Density value through the numerical keyboard. This is useful to determine the correct density setting for the used substrate. Using a test label will also indicate whether the coding unit is mounted parallel to the counter pressure platen.

Print - Touch the *Test* button to make a single print.

Auto print - This puts the printer into a mode where pressing the front button on the coding unit once will cause the printer to print rapidly and repeatedly. To stop the print process press the front button again.



Beware:

The system will print as fast as possible with the current settings and label. This is very fast and should not be used often. To observe whether the printer is capable of reaching the maximum prints per minute is a useful test though. One can slow the number of prints per minute down by increasing the delay value. This is only a diagnostic function and should only be used by qualified personnel. This is only a diagnostic function and should only be used by qualified personnel.

9.1.6 Reset Ribbon

This function should be used to reset the ribbon length whenever a new roll of ribbon is fitted to the printer. The ribbon length will be reset to the set *Ribbon length*, see section 8.6.2.

1. Touch the *Reset Ribbon* button to enter the reset ribbon menu.
2. Touch *Reset* to start the reset procedure.

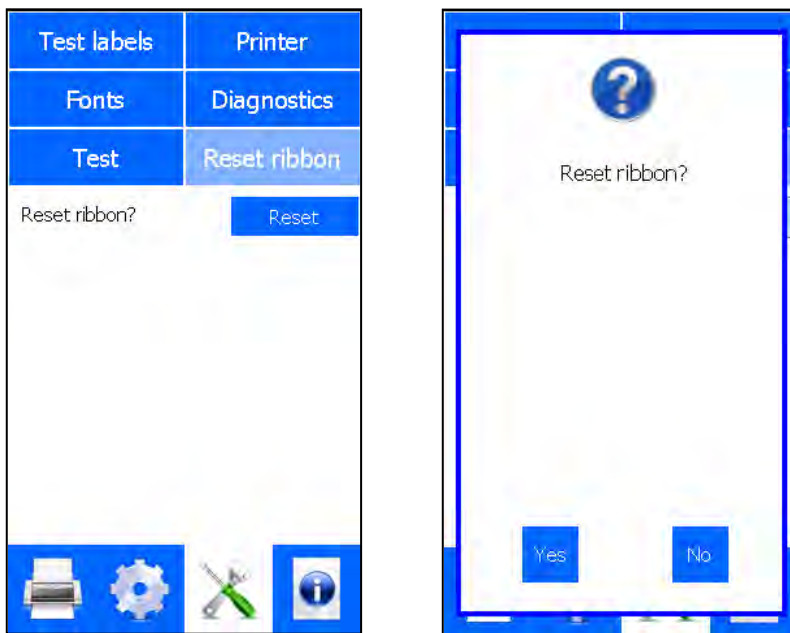

Fig. 9.13 Reset Ribbon menu

3. Touch Yes to confirm resetting of the ribbon length.

9.2 Information

Touch the *Information* icon located at the bottom of the screen.

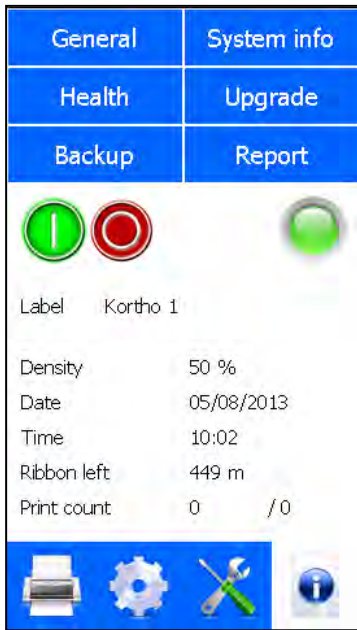

Fig. 9.14 Information menu

9.2.1 General

Touch the *General* button to display the information screen containing the general information.

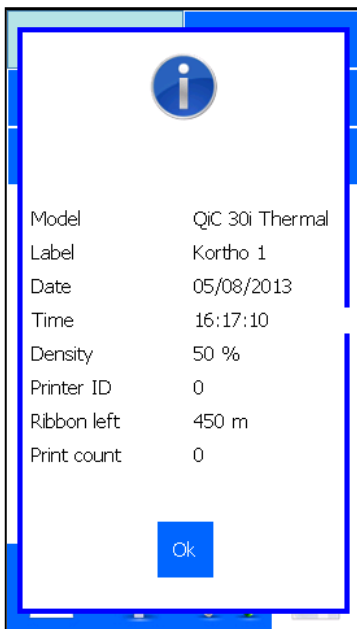

Fig. 9.15 General information screen

Model - model of the printer connected to the control unit.

Label - the name of the currently loaded label.

Date - system date of the control unit.

Time – system time of the control unit.

Density - the percentage of heat applied to the ribbon during printing.

Printer ID – the printer ID as defined by the user.

Ribbon left - the length of remaining ribbon on the magazine, measured in metres.

Print count - the total number of prints made with the current label, without changing to another label in between.

9.2.2 System Info

Touch the *System* button to display the information screen containing the system information.

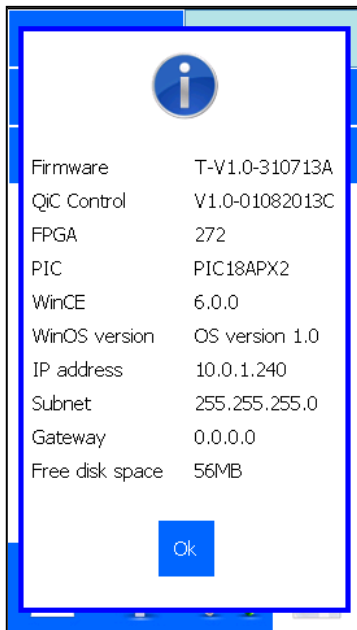

Fig. 9.16 System information screen

Firmware – the firmware that controls the main board.

QiC Control – the software that creates the user interface.

FPGA – the software that handles numerous functions in the system e.g. the printhead data.

PIC – the software that handles the timing and temperature of the printhead.

WinCE – the software version of the Windows CE version running on the user interface hardware.

WinOS Version - the build version of the image that is used to flash the user interface hardware.

IP Address/Subnet/Gateway – the set network address of the control unit.

Free disk space – the space that's still available for downloading new labels in the control unit.

9.2.3 Health

Touch the *Health* button to show printing statistics.

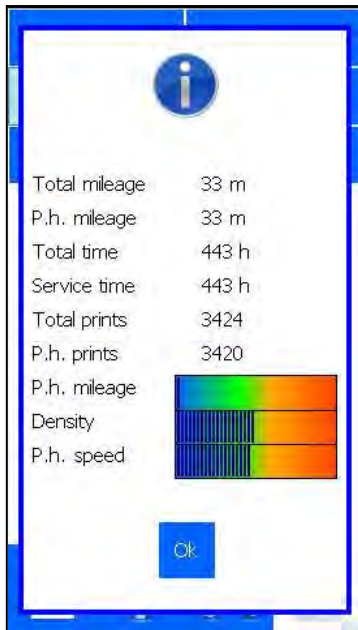

Fig. 9.17 Health screen

Total mileage - the total distance that the system has printed.

P.h. mileage - total distance the currently mounted print-head has printed. After changing the printhead this distance should be reset by using the QiC Draw program (Clear printhead mileage).

Total time - the total time the system has been switched on.

Service time - the time since the last service. During a service visit this time should be reset.

Total prints - the total number of prints the system has made.

P.h. prints - the number of prints that the currently mounted printhead has made. After changing the printhead this number should be reset by using the QiC Draw program (Reset service).

P.h. mileage - a visual representation of how much distance the printhead has printed compared to the expected life of the printhead.

Density – a visual representation showing the current setting for heat applied to the ribbon during printing. Generally a lower density setting is resulting in a longer printhead life time.

P.h. speed – a visual representation showing the speed at which the printhead is printing. The speed shown is the speed of the last print made. Generally a lower speed is resulting in a longer printhead life time.

9.2.4 Upgrade

This function is used to upgrade the user interface software, QiC Control. To upgrade the software:

1. Insert a USB thumbdrive that contains the upgrade file (TsC12*.CAB), located in the root of the drive.



CAUTION:

Do not use an extension cable for connecting the USB thumbdrive to the control unit, but place the USB thumbdrive directly in the control unit. Using an extension cable can cause EMC interference.



Note:

Make sure only upgrade file of the QiC Control version that should be installed is present on the USB thumbdrive. Otherwise there is a chance that the wrong version will be installed.

2. Touch the *Upgrade* button, the following screen will be displayed.



Fig. 9.18 Upgrade files detected screen

3. Touch the *Yes* button to start the upgrade process.

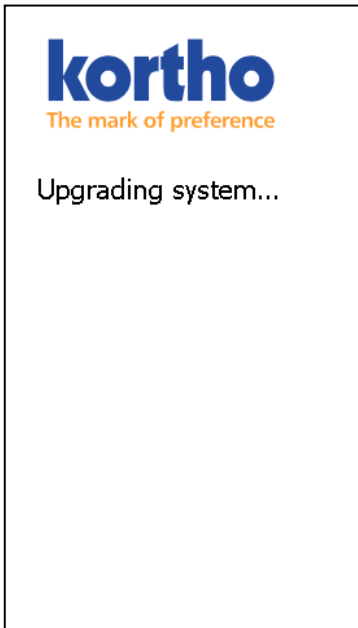

Fig. 9.19 Upgrade in progress screen

4. The system will upgrade in less than 20 seconds.
5. Reboot the system to finish the installation process.

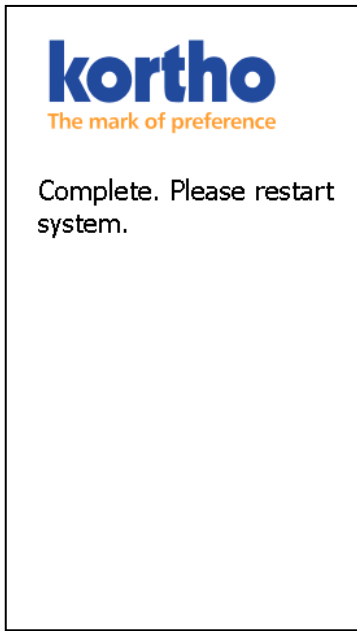

Fig. 9.20 Upgrade finished screen

9.2.5 Backup

This function backups the labels on the system onto a USB thumbdrive.

1. Insert a USB thumbdrive and wait for 4 seconds so it can be detected and mounted.



CAUTION:

Do not use an extension cable for connecting the USB thumbdrive to the control unit, but place the USB thumbdrive directly in the control unit. Using an extension cable can cause EMC interference.

2. Touch the *Backup* button.
3. Enter a suitable name for the backup folder.



Fig. 9.21 Enter Backup name

4. Touch the *Enter* button to save the backup.

5. If the name already exists a file overwrite message will be displayed. Touch *Yes* and the backup file will be overwritten. Touch *No* and the backup operation will be cancelled.

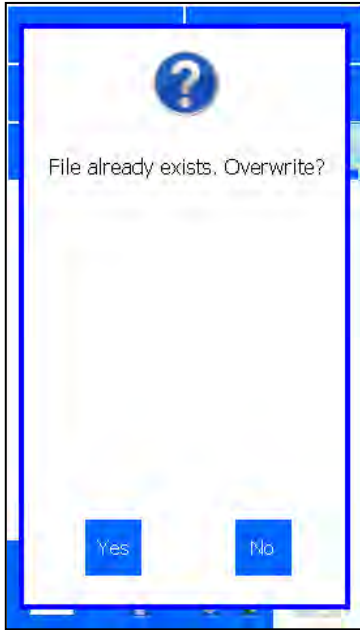

Fig. 9.22 Backup overwrite

6. While creating the backup folder and backing up the labels a timer icon will be shown on screen.

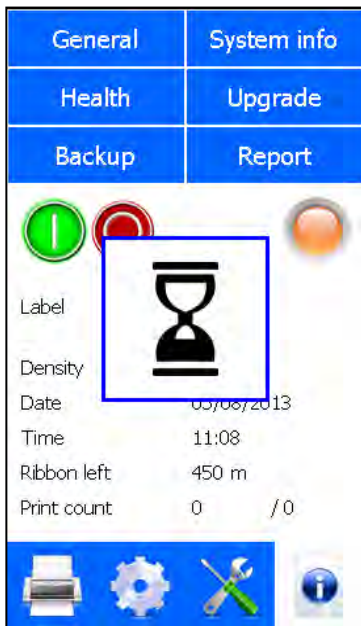

Fig. 9.23 Backup in progress

7. Wait until the message that the backup was successful appears on screen.

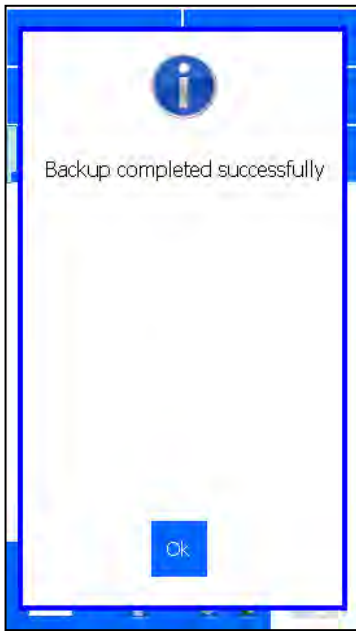

Fig. 9.24 Backup finished

8. Touch *Ok* to confirm and to return to the previous menu.
9. Remove the USB thumbdrive, the disk will contain a folder named "KorthoBackup_<xxx>" ((<xxx> being the name one has entered at step 3).

9.2.6 Report

This function generates a service report containing the printer settings and a scope trace file. This service report can either be opened as a text file or loaded into the service part of QiC Draw. The scope trace file can be opened in the oscilloscope function in the service part of QiC Draw.

When seeking assistance from Korthofah BV or your local distributor it is recommended that these two files are submitted.

To generate a report

1. Insert a USB thumbdrive and wait for 4 seconds so it can be detected and mounted.
2. Touch the *Report* button.
3. Enter a suitable <name> for the report.



Fig. 9.25 Enter report name

4. Touch the *Enter* button to save the report.
5. If the name already exists a file overwrite message will be displayed. Touch *Yes* and the report files will be overwritten. Touch *No* and the report operation will be cancelled.

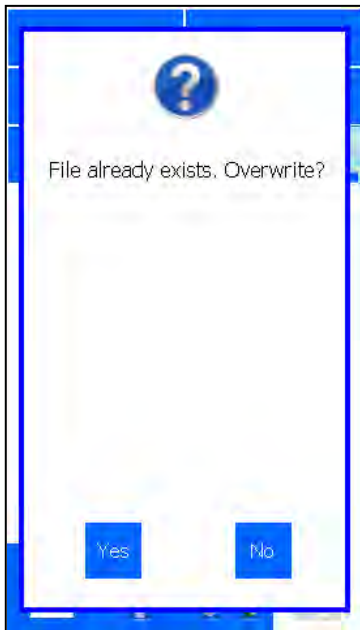

Fig. 9.26 Report overwrite

6. Wait until the message that the Report Saved appears on screen.



Fig. 9.27 Report saved

7. Touch *Ok* to confirm and to return to the previous menu.
8. Remove the USB thumbdrive, the disk will contain the files with the name names "KorthoReport_<xxx>" for the service report and "Scope_KorthoReport_<xxx>" for the scope trace file (<xxx> being the name one has entered at step 3).

9.3 Screen calibration

If the screen calibration is not correct, the screen can be re-calibrated during the boot sequence of the control unit.

1. Touch the calibration screen which appears on screen just after the timer icon and just before the user interface starts up.
2. Follow the instructions on screen (touch the centre and the 4 corners).

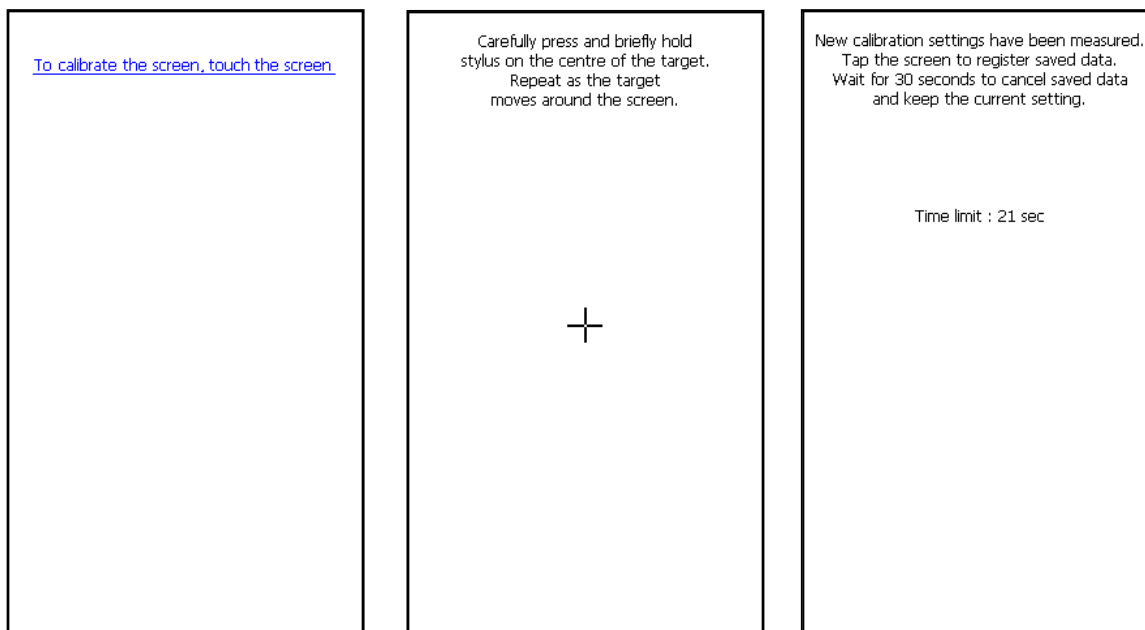

Fig. 9.28 Calibration screens

3. To confirm the new calibration settings, touch the screen. Alternatively wait for 30 seconds and the control unit will reload the previous calibration setting.

9.4 Fault finding

9.4.1 Control unit

Fault indication	Symptom(s)	Action(s)
Control unit does not power up.	Blue power LED on the coding unit remains off	Check whether the mains voltage is present.
		Check whether power cable connector is properly connected to Control unit and mains power supply.
	The user interface remains dark	Check whether the power cable is not damaged.
		Check whether ON-OFF switch is in the position I.
Ethernet LED's (visible at the back) remain off	These actions should only be performed by qualified personnel.	
	Disconnect power cable (X1) from mains power supply first!	
		Check the fuses in the power entry module (X1).
		Check whether internal mains wiring is connected properly.
Control unit does not boot up.	Blue power LED on the coding unit is lit	These actions should only be performed by qualified personnel.
		Disconnect power cable (X1) from mains power supply first!
	The user interface remains dark	Check whether the power cable of the user interface panel is properly connected.
Check whether user interface panel-flat cable is not damaged.		
		Check whether a "burning smell" is present in control unit. If so, contact your local dealer.
Control unit does not boot up.	Power LED on the coding unit is lit	These actions should only be performed by qualified personnel.
	Touch screen is backlit	Disconnect power cable (X1) from mains power supply first!
		Check whether a "burning smell" is present in control unit. If so, contact your local dealer.
Touching the buttons on screen will not result in a proper response		The screen calibration is incorrect. Recalibrate the screen, see section 9.3
The label cannot be downloaded to the system.		The label file on the USB thumbdrive may be corrupt. Ensure when transferring information that the flash device is removed properly. Check whether the label is ok by opening it in the label design program. Alternatively create the label again and try to download it again. If the problem remains present contact your local dealer.

DIAGNOSTICS / TROUBLESHOOTING

The font required cannot be downloaded to the system.		The font may be too large. Check with your local dealer. The file on the USB thumbdrive may be corrupt. Ensure when transferring from a PC the USB thumbdrive is removed properly.
The label cannot be selected for printing		The label file stored in the label memory may be corrupt, download again. The label file stored in the print memory may be corrupt, select again. The fonts that are used for the text, date or time items in the label have not been installed.
The printer is not printing on request.		System is in pause mode (the red indicator is lit – warning is displayed on screen). The number of prints has reached the value set in print count (the green status LED on the coding unit is flashing, the status screen shows the print count x / x) Print request sensor (or cable) is defect or not sensing the product/mark. System is in error mode (the orange LED on the coding unit is on and general alarm output is active).
A half roll of ribbon is left, but the QiC TsC12 advises it has run out of ribbon.	Low ribbon output is active and status LED is flashing orange.	Check the Ribbon length setting. The entered number of meters should correspond with the length of ribbon on the roll.
The roll of ribbon has been replaced but the setting is showing low.	Low ribbon output is active and status LED is flashing orange.	Reset the ribbon count.
Printer is showing an error or warning message.	LED is flashing orange.	View the error/warning list for more information (Diagnostics - Printer – Errors).
The user interface is only showing a blank screen.		Reset the control unit, by switching the control unit off and after 10 seconds on again.

9.4.2 Coding unit

Fault indication	Symptom(s)	Action(s)
The printer is showing a fault.	Orange LED on. An error message is displayed on the user interface.	Check the error displayed by the control unit.
It is hard to remove		Check whether the guideposts are bent. If so the magazine may

DIAGNOSTICS / TROUBLESHOOTING

and/or to replace the magazine.		have been dropped and will need to be repaired or replaced.
After changing the ribbon the system does not print anymore.		Check whether the ribbon is placed correctly.
There is air leaking from the printer.		Check air fittings, tubes and connections to the printer. If the air leak seems to originate from within the coding unit, turn off the air and power and call for technical assistance.
The orange status LED is still shown even though the magazine has been placed back in position.		Press the button on the front of the coding unit to reset the error. The status light should turn green if a label is loaded. If not check the error displayed by the control unit.
It is hard to get the wound up ribbon from the rewind spool.		Check whether the rewind spool tension settings are Ok. Check whether the correct ribbon with plastic cores has been used (wall thickness 3mm). Verify whether the air pressure is set to 0,4 MPa (4 bar) (0,5 MPa for QiC 107i).
Carriage encoder problem.		Check whether the air is applied to the printer. Remove the magazine and lower the printhead. Manually move the printhead and check for any obstruction. Check whether the encoder strip is in position. Check whether the encoder strip is clean, see also section 10.4. Check whether the encoder sensor is clean. Check the encoder sensor and cable for damage are check whether the cable is correctly mounted.
		Check the cable between the control unit and the coding unit for damage are check whether the cable is correctly mounted.
Ribbon transport problem.		Ensure whether the ribbon has not broken or ran out. Check whether the ribbon is correctly routed on the magazine including around the ribbon sensor roller. Ensure that the magazine is fully inserted and secured when fitted to the printer. Verify whether the air pressure is set to 0,4MPa (4 bar) (0,5 MPa for QiC 107i).
Print encoder timeout.		Remove the magazine and lower the printhead. Manually move the printhead and check for any obstruction. Make sure the carriage can travel the complete length of the maximum label height Ensure the label is not too large for the printer (max 30mm length).

Home timeout.		<p>Verify whether the air pressure is set to 0,4MPa (4 bar) (0,5 MPa for QiC 107i).</p> <p>Remove the magazine and lower the printhead.</p> <p>Manually move the printhead and check for any obstruction.</p> <p>Ensure that the print head can reach the full home position.</p>
Print position timeout.		<p>Check whether the air is applied to the printer.</p> <p>Verify whether the air pressure is set to 0,4MPa (4 bar) (0,5 MPa for QiC 107i).</p> <p>Remove the magazine and lower the printhead.</p> <p>Manually move the printhead and check for any obstruction.</p>
Print missed.		<p>Ensure that production line speed has not been increased and the substrate is running free.</p> <p>Check position of print sensor.</p>

9.4.3 Print request signal sensor

Fault indication	Action(s)
Sensor does not detect passing product..	<p>In case of a photocell:</p> <ul style="list-style-type: none"> - Check whether the lens (front side) of the photocell is clean. - Check whether the sensitivity of the photocell is properly set. - Check whether the photocell connector (X3) is properly connected to the control unit. - Check whether the photocell does not detect anything in the background. Normally, the LED indicator on the photocell is off if no substrate is present.
	<p>In case of a switch/relay/PLC contact:</p> <ul style="list-style-type: none"> - Check whether the interface cable connector (X3) is properly connected to the control unit. - Check whether the signal is really generated. - Check whether all wiring between sensor and control unit is mounted correctly.

9.5 Error/warning messages

When problems occur the system will generally report an error message. The error message will be displayed on screen. As example see Fig. 9.29. Depending on the kind of error, the alarm output will also be set. Besides error messages the system will also report several warnings.

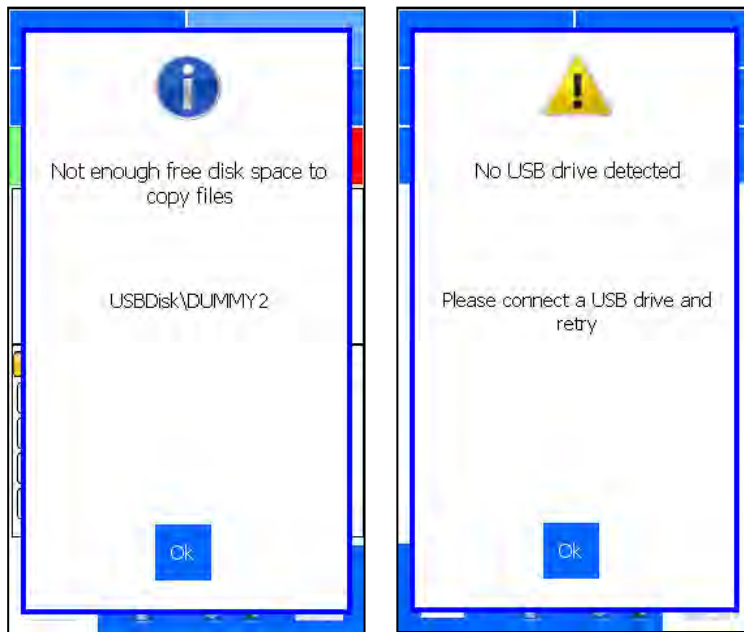

Fig. 9.29 Error and warning message

For a list of all the errors / warnings that can be generated, see Appendix G.

9.6 Poor print quality

Fault indication	Action(s)
Poor print quality in general.	Check the density. Check whether the coding unit is correctly mounted within its frame. Check whether the platen is not worn, is clean and is smooth. Also check for air bubbles within the pad. Check whether the ribbon used is suitable for the substrate to be printed. Check whether the ribbon is loaded correctly for the application i.e. ink side out. Verify whether the air pressure is set to 0,4MPa (4 bar) (0,5 MPa for QiC 107i).
Parts of the label are missing and white lines appear within the printed label (Fig. 9.30)	Check whether the printhead has been cleaned recently. Check whether the printhead has some damaged pixels and requires replacing. Check whether the platen surface is clean. Check whether the platen surface is not damaged, otherwise replace it.
Labels are only partially printed.	Check whether the prints on the ribbon are overlapping. If so: - Check the ribbon encoder. - Check whether the ribbon core notches engage with the magazine.
The ribbon width has been changed from 35mm to 55mm as a wider label needs to be printed. The printed labels shows faint areas about 35mm apart.	The printhead has been worn out on the edges due to the narrower ribbon and requires replacing.

DIAGNOSTICS / TROUBLESHOOTING

<p>The contrast of the printed label is decreasing as it is printed</p>	<p>Check whether the coding unit is mounted in its frame correctly. Check whether the coding unit is level and that the gap between the thermal printhead and platen is no more than 3mm. Verify whether the air pressure is set to 0,4MPa (4 bar) (0,5 MPa for QiC 107i).</p>
<p>The labels are not being printed at the correct size or position.</p>	<p>Check whether a timing or print request signal issue affects the setup (e.g. is the substrate stopped when the system printer starts printing). Check whether the delay setting is either too low or too high. Check whether the substrate adjustment roller is correctly positioned. Ask for technical assistance if the problem remains.</p>
<p>The begin of the print is vague (Fig. 9.31) but the platen is level with the printhead</p>	<p>Check with QiC Draw whether the print speed is Ok. Reduce the print speed with the speed adjustment screw if required.</p>

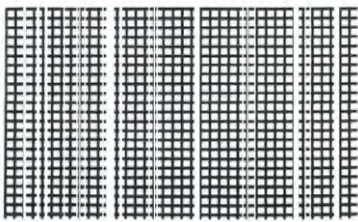

Fig. 9.30 Grid test label printed with white lines in the print (print direction is from top to bottom)

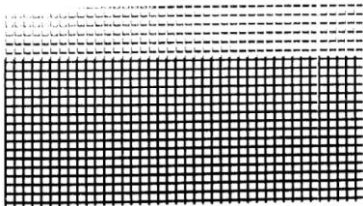

Fig. 9.31 Grid test label printed with print speed too high (a speed peak at start of print)

10 MAINTENANCE

The family of QiC printers are designed specifically for robust operation and include unique patented mechanisms and systems to ensure long uninterrupted service. Key to ensuring optimal operation and extended life is appropriate maintenance. It is important to inspect the printer visually and check the print quality both on a regular basis.

The periods of maintenance are based on an average factory environment in which the printers are installed. Depending on the actual circumstances the periods of maintenance may vary.

This section covers the routinely maintenance that can be easily performed by the user.

10.1 Daily maintenance



WARNING:

Turn off power before performing maintenance tasks.

To ensure a good print quality it is recommended to check the items as mentioned in this section every day.

10.1.1 Printhead

To ensure the printer is printing effectively it is important to clean the printhead regularly.



CAUTION:

Under NO circumstances should a sharp tool be used while maintaining the printhead. Any damage caused by sharp object will void the warranty.

To clean the printhead remove the magazine and place the printhead in his upwards position. Clean the printhead with a lint free cloth soaked in isopropanol (2-propanol or isopropyl alcohol (IPA)). Wipe the heater line surface as marked in the Fig. 10.1.



CAUTION:

Always follow the Safety guidelines presented in the SDS of the cleaning solution used.

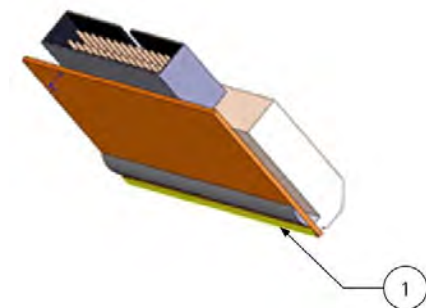

1. Heater line surface (on the edge of the thermal printhead)

Fig. 10.1 Cleaning the printhead

Check the print for missing lines. The printhead is constructed using extremely small thermal heaters (12 per millimetre). Eventually these individual heaters become worn resulting in missing lines. Replace the printhead if required.



CAUTION:

Before removing the printhead the power and air should be disconnected. All maintenance should be carried out by qualified personnel, preferably those that have attended the formal training session offered by Korthofah. Refer to section 10.5.

10.1.2 Platen

It is important that there are no air bubbles, indentations or debris in or on the platen material, as this will cause poor prints and can damage the printhead.

Over long periods of time or use it may be necessary to change the platen due to deterioration of the hardened rubber material.



Note:

Occasionally repositioning the platen can average the wear and increase the life span of the platen.

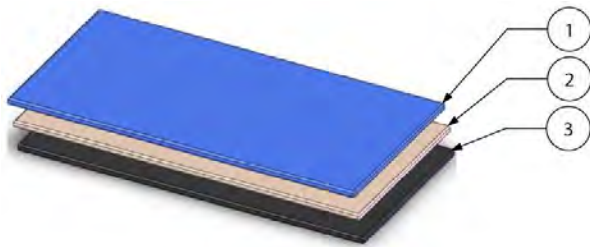

- 1. Hardened rubber sheeting
- 2. Cushioning material
- 3. Magnetic metal sheet

Fig. 10.2 Platen composition

10.2 Maintenance after replacing the ribbon roll

Each time the ribbon roll needs to be replaced the magazine needs to be cleaned.

Clean the ribbon movement sensor roller and the pressure roller with a lint free cloth soaked in isopropanol (2-propanol or isopropyl alcohol (IPA)) to remove debris, dirt and dust.



CAUTION:

Always follow the Safety guidelines presented in the SDS of the cleaning solution used.

Check the ribbon movement sensor spring for damage, replace the spring if required.

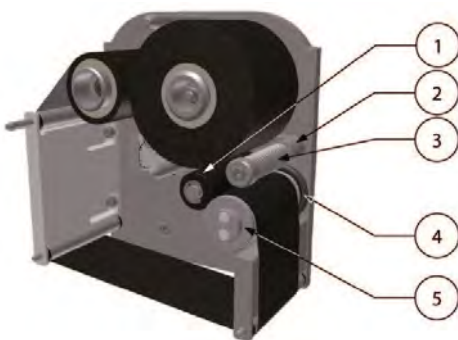

- 1. Pressure roller
- 2. Pressure roller arm
- 3. Pressure roller spring
- 4. Ribbon movement sensor spring
- 5. Ribbon sensor roller

Fig. 10.3 Magazine cleaning

Make sure the pressure roller can move freely and firmly towards the ribbon movement sensor roller. Clean the pressure roller arm if required.

10.3 Weekly maintenance

It is recommended that the system is cleaned and that all connections are checked once a week. In addition the water separator of the air reduction valve should be monitored for the presence of water content. In that case, one should relieve the water from the water separator by pressing the shutoff valve at the bottom of the water separator.

The Health check monitor should be used to ensure the system remains in good condition.

10.4 Half yearly and yearly maintenance

**WARNING:**

When removing covers all air and mains power should be disconnected.

Every half year the rear cover should be removed to check the condition of the cables and remove any debris, dirt and dust. Extra attention should be paid to the cleaning of the encoder strip. The encoder strip should be taken out of the printer and cleaned with a soft nonabrasive cloth.

**CAUTION:**

Do not use any cleaning solutions as this can permanently damage the encoder strip.

To guarantee a optimal clutch action, and so an optimal ribbon transport, it is advised to lubricate the clutch every 6 months with a thin layer of Klübersynth UH1 14-151.

To prevent loss of production it is advisable to service the printer once a year. Only service engineers, qualified by Korthofah BV, are allowed to service the printer.

10.5 Printhead replacement

**WARNING:**

The mains power and air supply must be disconnected when replacing the printhead.

**CAUTION:**

Read Printhead safety notes before handling the thermal printhead. Always ensure anti-static precautions are observed when handling a thermal printhead or printed circuits boards or they might get damaged.

**CAUTION:**

Be careful when touching / exchanging the printhead. The printhead could be very warm and has some sharp edges on which one can cut oneself.

10.5.1 Printhead safety notes

The enclosed Thermal Printhead is a static sensitive device.

In order to avoid potential damage to the Printhead please ensure anti-static precautions are observed throughout the installation procedure.

Korthofah cannot be held responsible for damage to the printhead caused by mishandling.

Before installing the printhead, please adhere to these precautions:

- Ensure that the printer is switched off and isolated from the mains supply.
- Discharge yourself before handling the equipment (a grounding wrist strap should be used).
- Do not touch any components on the printhead with your hand or any other conductive equipment.
- Do not touch the heater line surface with bare hands to avoid corrosion.
- Do not place the equipment on or near materials such as Styrofoam, plastic and vinyl. Keep printhead in anti-static bag used for transporting until ready to fit.

Other useful precautions:

- Residue on heater line should be removed with ethanol or isopropanol in order to avoid extensive wear.
- Adjust the coding unit to have an even pressure across the width of the printhead.
- Use ribbon which is free from Na+, K+, and Cl- ions.
- Use ribbon which is designed to reduce the friction between the printhead and the ribbon.
- Use a ribbon which is designed not to generate static voltages.
- The printhead should be free from any condensation to avoid corrosion.

10.5.2 Printhead replacement

1. Use a 2.5mm Allen key to remove the two screws holding the thermal printhead in place.



Note:

Removing the air pressure allows the head to lower and provide easier access to the two screws.

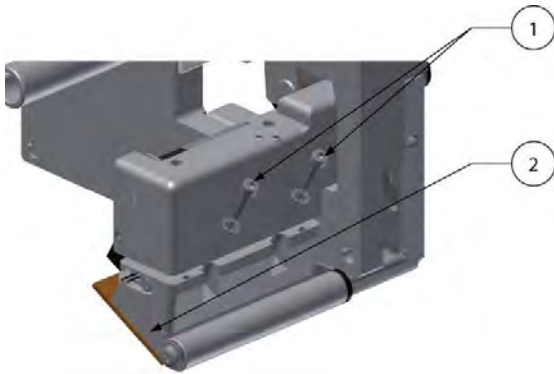

1. Printhead screw
2. Printhead

Fig. 10.4 Removing thermal printhead screws

2. Take the connector clamp (1 in Fig. 10.5) from the cable connector.
3. Disconnect the cable plug from the thermal printhead socket.



CAUTION:

The cable plug should be gently taken out of the printhead socket taking care not to pull directly on the wires.



- 7. Connector clamp
- 8. Printhead connector

Fig. 10.5 Disconnect the cable plug from the printhead socket

4. Note the printhead resistance value identified on the new printhead.
5. Refit the new printhead, reversing the steps 1 to 3. Ensure the cable plug(s) is (are) firmly replaced in the printhead connector(s) taking care not to bend any connector pins. Ensure the lock clip(s) of the connector(s) is (are) in place.



CAUTION:

Make sure the connector is secured by the connector clamp (2).

6. Switch on the system and adjust the printhead resistance value, see section 8.6.2, before making any print.

10.6 Updating firmware and software

The firmware and software can be updated. Only the user interface software can be updated by the user, see section 9.2.4. Only service engineers, qualified by Korthofah BV, can and are allowed to update the other software and firmware versions.

11 DISMANTLING & DISPOSAL

At the end of the technical lifetime of the system it should be dismantled and disposed according to local regulations. The general guide line to do so is described.

11.1 Dismantling

Separate the printer parts in this order:

11.1.1 System

1. Switch off the system.
2. Unplug the mains power cable.
3. Disconnect all remaining connections from the control unit.
4. Remove the supports.
5. Separate the supports from the coding unit and the control unit.

11.1.2 Coding unit

1. Open the back cover of the coding unit.
2. Remove the printed circuit board.
3. Remove the LED's, wire loom, carriage encoder module and the ribbon encoder.
4. Remove the printhead.
5. Treat the printed circuit board and the printhead as electronic waste.

11.1.3 Control unit

1. Open the control unit.
2. Remove the printed circuit boards.
3. Remove the touch panel.
4. Remove the LED's, net-entry and wire looms.
5. Remove the power supplies.
6. Treat the printed circuit boards, touch panel and power supplies as electronic waste.

11.1.4 Sensor devices

1. Treat the photocell as electronic waste.

11.1.5 Ribbon

1. Recycle or dispose of waste in compliance with current local legislation, preferably via a certified collector or company. Do not contaminate the ground or water with waste, do not dispose of waste into the environment.

11.2 Disposal

11.2.1 Disposal method

The disposal method must be in accordance with national and local regulations at the time of the disposal.

The user is responsible for the disposal of:

1. The printer at the end of its operational life.
2. Waste ribbon and unused ribbon at the end of the printer's operational life.
3. Packaging.

11.2.2 Waste separation

Deliver the packaging materials to a certified waste recycling company.

Printed circuit boards, power supplies, touch panel, net-entrée, encoders and wire looms are considered electronic waste, because poisons found in electronic waste include lead, mercury, cadmium, and brominated flame-retardants commonly added to plastics used in electronics. As the system is RoHS compliant the amount of hazardous materials mentioned above will be limited.

The remaining materials consist mainly of anodized aluminium and stainless steel.

The remaining materials must be delivered to a certified waste recycling company.

Index

■ Keywords

A

anti-static 4-2, 10-3, 10-4

B

bitmap 3-1

bracket 1-2, 6-1, 6-2, 6-4

C

coding unit 1-2, 1-3, 1-5, 2-1, 3-2, 3-3, 3-4, 4-4, 4-5, 5-1, 5-2, 6-1, 6-2, 6-3, 6-4, 7-1, 7-4, 8-1, 8-13, 8-20, 9-2, 9-7, 9-9, 9-19, 9-20, 9-21, 9-23, 9-24, 10-4, 11-1

control unit 1-1, 1-3, 2-1, 2-3, 3-1, 3-2, 3-3, 3-4, 3-9, 4-2, 4-3, 4-4, 4-5, 5-2, 6-1, 6-2, 6-4, 7-4, 7-5, 8-1, 8-21, 9-3, 9-4, 9-5, 9-7, 9-10, 9-11, 9-18, 9-19, 9-20, 9-21, 9-22, 11-1

D

debounce 8-28

E

electrostatic 1-5, 4-6

F

firmware 3-4, 3-9, 8-26, 9-4, 9-5, 9-11, 10-5

front button 3-4, 4-4, 8-12, 8-13, 9-2, 9-7, 9-9

function 4-2, 7-5, 8-1, 8-9, 8-10, 8-11, 8-19, 8-20, 8-21, 8-22, 8-23, 8-25, 8-27, 9-2, 9-8, 9-9, 9-12, 9-14, 9-16

button 3-2, 3-3, 3-4, 3-5, 3-6, 3-7, 3-8, 4-4, 7-4, 7-5, 8-1, 8-2, 8-6, 8-7, 8-10, 8-12, 8-14, 8-15, 8-16, 8-17, 8-18, 8-19, 8-20, 8-21, 8-22, 8-23, 8-24, 8-25, 8-26, 8-27, 9-1, 9-2, 9-3, 9-4, 9-5, 9-7, 9-9, 9-10, 9-11, 9-12, 9-13, 9-14, 9-16, 9-17, 9-19, 9-21

H

handling 3-2, 4-2, 4-6, 5-1, 5-2, 8-12, 10-3, 10-4

host 1-1, 1-3, 2-1, 3-1, 4-4, 4-5, 6-1, 6-3, 6-4, 8-22, 8-27, 9-7

humidity 1-2, 1-3, 1-4, 8-27

I

image 9-5, 9-11

index 2-3

indicator 3-2, 3-3, 3-4, 9-20, 9-22

ink 1-4, 5-2, 9-23

interface 1-3, 3-2, 4-3, 4-5, 6-4, 7-4, 8-16, 8-18, 9-5, 9-11, 9-12, 9-18, 9-19, 9-20, 9-22, 10-5

M

magazine 2-3, 3-2, 3-4, 4-4, 7-1, 7-2, 7-5, 8-12, 8-13, 8-20, 9-4, 9-7, 9-11, 9-21, 9-20, 9-21, 9-22, 9-23, 10-1, 10-2

maintenance 1-1, 1-5, 3-2, 4-1, 4-2, 6-3, 10-1, 10-3

memory 1-1, 1-5, 2-1, 7-6, 8-8, 8-9

label 1-1, 1-5, 4-3, 8-6, 8-7, 8-8, 9-20

print 1-1, 1-4, 3-1, 9-20

menu structure 3-2, 3-9

O

operator 1-1, 1-4, 3-2, 3-4, 6-4, 8-2, 8-3, 8-4, 8-5, 8-6, 8-18, 8-20

orientation 8-17, 8-18, 8-26

INDEX

P	
parameter	4-3, 8-1, 8-23
date	1-1, 1-4, 2-1, 3-1, 4-2, 7-4, 8-4, 8-15, 8-19, 9-2, 9-4, 9-6, 9-10, 9-20
direction	8-25, 9-24
language	4-3, 7-4, 8-15, 8-16, 8-17
speed	1-4, 7-5, 9-12, 9-22, 9-24
time	1-1, 1-3, 1-4, 2-1, 3-1, 3-2, 4-2, 4-3, 5-1, 5-2, 7-4, 8-5, 8-15, 8-19, 8-21, 8-23, 8-27, 8-28, 9-6, 9-11, 9-12, 9-20, 10-2
platen	2-1, 3-2, 4-3, 4-4, 6-3, 7-2, 7-4, 7-5, 7-6, 9-9, 9-23, 9-24, 10-2
power supply	1-3, 4-4, 4-5, 9-3, 9-19
precautions	4-2, 4-6, 10-3, 10-4
print	
cycle	3-1, 4-2, 4-3, 6-1, 7-4, 8-28
test	1-4, 3-2, 8-12, 9-8
printhead	1-4, 1-5, 2-1, 2-3, 3-1, 3-2, 3-4, 4-1, 4-2, 4-3, 4-6, 5-1, 5-2, 6-2, 7-2, 7-4, 7-5, 7-6, 8-20, 8-21, 8-22, 8-27, 8-28, 9-3, 9-5, 9-7, 9-11, 9-12, 9-21, 9-22, 9-23, 9-24, 10-1, 10-2, 10-3, 10-4, 10-5, 11-1
product	4-1, 5-2, 5-3, 8-22, 8-23, 8-25, 8-27, 9-20, 9-22
protection	1-1, 1-3, 1-4
Q	
qualified	1-1, 4-2, 9-9, 9-19, 10-1, 10-3, 10-5
R	
ribbon	1-2, 1-3, 1-4, 2-3, 3-1, 3-2, 3-4, 4-1, 4-2, 5-3, 7-1, 8-6, 8-13, 8-20, 8-23, 8-27, 8-28, 9-4, 9-7, 9-9, 9-11, 9-12, 9-20, 9-21, 9-23, 10-2, 10-4, 11-1
S	
safety	4-2, 10-3
SELV	1-3, 4-3, 4-5
sensor	2-1, 7-1, 8-13, 8-22, 9-3, 9-7, 9-20, 9-21, 9-22, 10-2
encoder	3-1, 4-4, 8-13, 8-23, 9-7, 9-21, 9-23, 10-3, 11-1
photocell	3-1, 6-1, 9-22
storage	5-2
substrate	1-4, 1-5, 2-1, 3-1, 3-2, 4-2, 6-3, 6-4, 7-1, 7-4, 7-5, 8-21, 8-22, 8-27, 8-28, 9-9, 9-22, 9-23, 9-24
symbol	
note	2-6, 4-5, 6-1, 7-5, 8-1, 8-2, 8-7, 8-12, 8-16, 8-18, 8-21, 8-28, 9-5, 9-6, 9-7, 9-13, 10-2, 10-4, 10-5
warning	10-1, 10-3
T	
temperature	1-2, 1-3, 1-4, 3-2, 3-4, 5-2, 7-5, 8-21, 8-27, 9-3, 9-5, 9-11
touch screen	3-2
transport	3-1, 5-1, 5-2, 5-3, 9-21
trigger	3-4, 8-23
request	2-1, 3-1, 4-2, 4-3, 6-1, 6-3, 8-1, 8-2, 8-18, 8-27, 8-28, 9-24
V	
voltage	1-3, 4-3, 4-4, 4-5, 9-3, 9-19
W	
waste	11-1

■ Figures

Fig. 1.1	Coding units, global dimensions	1-2
Fig. 1.2	Control unit, global dimensions	1-2
Fig. 1.3	Ribbon	1-4
Fig. 2.1	The printer system	2-1
Fig. 2.2	Coding unit, parts	2-2
Fig. 2.3	Coding unit, interior parts front	2-2
Fig. 2.4	Magazine, parts	2-2
Fig. 2.5	Coding unit, interior parts back	2-3
Fig. 2.6	Control unit + adjustable support	2-4
Fig. 2.7	Control unit, connections	2-4
Fig. 2.8	Air regulator	2-5
Fig. 2.9	QiC Draw main window	2-5
Fig. 3.1	Screen layout, main menu portrait	3-3
Fig. 3.2	Screen layout, main menu landscape	3-3
Fig. 3.3	LED indicators and front button	3-4
Fig. 3.4	First keyboard screen	3-5
Fig. 3.5	First keyboard screen, alternative alphanumerics	3-5
Fig. 3.6	Second keyboard screen, numeric and special characters	3-6
Fig. 3.7	Third keyboard screen, commonly used text	3-6
Fig. 3.8	Programming third keyboard screen buttons, entering text	3-7
Fig. 3.9	Programming third keyboard screen buttons, entering text	3-7
Fig. 3.10	Fourth keyboard screen, edit text and use cursor controls	3-8
Fig. 3.11	Numeric keyboard	3-8
Fig. 3.12	Entering the System information screen	3-9
Fig. 3.13	Standard menu structure	3-9
Fig. 4.1	Control unit identification label	4-4
Fig. 4.2	Power supply information	4-4
Fig. 4.3	Attention label for opening control unit	4-5
Fig. 5.1	Shipping and handling labels	5-1
Fig. 6.1	Coding unit	6-2
Fig. 6.2	Control unit TsC12	6-2
Fig. 6.3	Positioning of the print	6-3
Fig. 6.4	Substrate adjustment	6-4
Fig. 7.1	Ribbon magazine	7-1
Fig. 7.2	Ribbon path label	7-1
Fig. 7.3	Adjustment of printhead gap	7-2
Fig. 7.4	Coding unit adjustment block	7-4
Fig. 7.5	Grid test label printed with incorrect alignment of printhead and platen (density 10%)	7-5
Fig. 7.6	Grid test label printed with correct alignment of printhead and platen (density 10%)	7-5
Fig. 7.7	Grid test label printed with correct alignment of printhead and platen (density 60%)	7-5
Fig. 7.8	Printer parameters, default and user values	7-6
Fig. 7.9	Printer environment information	7-6
Fig. 8.1	Main menu	8-1
Fig. 8.2	Main menu	8-2
Fig. 8.3	Text item input menu	8-3
Fig. 8.4	Date advance input menu	8-4
Fig. 8.5	Number start value input menu	8-5
Fig. 8.6	Select label menu	8-6
Fig. 8.7	Copy label menu, USB thumbdrive	8-7
Fig. 8.8	Copy label menu, label memory	8-7
Fig. 8.9	Overwriting label message	8-8
Fig. 8.10	Copy label(s) failed message	8-8
Fig. 8.11	Insufficient memory message	8-9
Fig. 8.12	Move label menu	8-9
Fig. 8.13	Paste label menu	8-10
Fig. 8.14	Delete label menu	8-10
Fig. 8.15	Delete label message	8-11
Fig. 8.16	Preview screen	8-11
Fig. 8.17	Unlock magazine	8-12
Fig. 8.18	Lock magazine	8-12
Fig. 8.19	Ribbon path	8-13

INDEX

Fig. 8.20	Settings menu	8-14
Fig. 8.21	System settings menu	8-14
Fig. 8.22	Date and Time menu	8-15
Fig. 8.23	System language selection menu.....	8-15
Fig. 8.24	Reboot message screen	8-16
Fig. 8.25	Date Language selection menu	8-17
Fig. 8.26	Screen orientation selection menu	8-17
Fig. 8.27	Reboot message screen	8-18
Fig. 8.28	Screensaver selection menu.....	8-19
Fig. 8.29	Rollover hour selection menu	8-19
Fig. 8.30	System settings menu	8-20
Fig. 8.31	Print head resistance	8-21
Fig. 8.32	Signal settings menu	8-22
Fig. 8.33	Network settings menu	8-24
Fig. 8.34	Network settings, IP address	8-24
Fig. 8.35	Label settings menu	8-25
Fig. 8.36	Orientation setting selection	8-26
Fig. 8.37	Orientation setting.....	8-26
Fig. 8.38	Print settings menu	8-27
Fig. 9.1	Diagnostics menu	9-1
Fig. 9.2	Test label menu	9-2
Fig. 9.3	Test label menu	9-2
Fig. 9.4	Printer main menu	9-3
Fig. 9.5	Printer diagnostics screen	9-3
Fig. 9.6	System information screen.....	9-4
Fig. 9.7	Software and firmware version screen.	9-4
Fig. 9.8	Error-Warning list	9-5
Fig. 9.9	Font list screen	9-6
Fig. 9.10	Diagnostics menu	9-7
Fig. 9.11	IO feedback screen	9-8
Fig. 9.12	Test menu	9-8
Fig. 9.13	Reset Ribbon menu.....	9-9
Fig. 9.14	Information menu.....	9-10
Fig. 9.15	General information screen.....	9-10
Fig. 9.16	System information screen.....	9-11
Fig. 9.17	Health screen	9-12
Fig. 9.18	Upgrade files detected screen	9-13
Fig. 9.19	Upgrade in progress screen.....	9-13
Fig. 9.20	Upgrade finished screen	9-14
Fig. 9.21	Enter Backup name	9-14
Fig. 9.22	Backup overwrite	9-15
Fig. 9.23	Backup in progress	9-15
Fig. 9.24	Backup finished.....	9-16
Fig. 9.25	Enter report name.....	9-17
Fig. 9.26	Report overwrite.....	9-17
Fig. 9.27	Report saved.....	9-18
Fig. 9.28	Calibration screens	9-18
Fig. 9.29	Error and warning message.....	9-23
Fig. 9.30	Grid test label printed with white lines in the print (print direction is from top to bottom)	9-24
Fig. 9.31	Grid test label printed with print speed too high (a speed peak at start of print)	9-24
Fig. 10.1	Cleaning the printhead	10-1
Fig. 10.2	Platen composition	10-2
Fig. 10.3	Magazine cleaning.....	10-2
Fig. 10.4	Removing thermal printhead screws	10-4
Fig. 10.5	Disconnect the cable plug form the printhead socket.....	10-5

Appendix A Specifications

Coding Unit

Dimensions

	QiC 30i	QiC53i	QiC107i
Height	196mm	196mm	196mm
Width	166mm	214mm	214mm
Depth	192mm	192mm	244mm

Weight

QiC 30i	QiC53i	QiC107i
6,2 kg	7,1kg	8,3kg

Print area

	QiC 30i	QiC53i	QiC107i
Width	53mm	53mm	107mm
Length	30mm	107mm	107mm

Print speed

50 – 500m/sec (depending on application/label length)

Prints per minute

	QiC 30i	QiC53i	QiC107i
10mm print	350	250	250
30mm print	180		
50mm print	NA	120	120
100mm print	NA	70	70

Print head

12 dots/mm (300 dpi)

Substrate

Synthetic foils (PP, PET, PE) and coated papers

Environment

Temperature	5 °C - 40 °C (41 °F - 104 °F)
Relative humidity	10% - 90% (non-condensing)

Control unit

Dimensions

Height	186mm
Width	198mm
Depth	239mm

Weight

3,3 kg

Power supply 30i and 53i

Voltage rating	100-120Vac	200-240Vac
Frequency rating	50 – 60 Hz	
Power rating	150VA max	
Current rating	1,55A	0,75A
Inrush current	<62A at 115Vac	<135A at 230VA
Fuse rating	2x T3,15A 250 Vac	

APPENDIX A, SPECIFICATIONS

Power supply 107i

Voltage rating	100-120VA	200-240Vac
Frequency rating	50 – 60 Hz	
Power rating	200VA max	
Current rating	2A	1A
Inrush current	<62A at 115Vac	<135A at 230Vac

Fuse rating 2x T3,15A 250 Vac

Environment

Temperature	5 °C - 40 °C (41 °F - 104 °F)
Relative humidity	10% - 90% (non-condensing)
Interface	USB port Ethernet connection Optically isolated inputs: print request, trigger, remote front button Optically isolated outputs: general alarm, busy, low ribbon / warning, spare output

Ribbon

Operational

Temperature (recommended) 10 °C – 30°C (50°F - 86 °F)

Transport and storage

Temperature	10°C - 30 °C (50 °F - 86 °F)
Precautions	store in original packaging away from direct sunlight
Shelf life	12 months

Label features

Label

Name:	User defined name. Optional a description and author can be added.
Test label:	Default label, which is useful for checking the print quality and correct setting of several parameters.
Items:	Text, multiple line text, number, date, time, shiftcode, barcode, line, circle/oval and box items and graphics. These items are placed in a label using the label design program.
Data:	Fixed and variable.
Size:	Maximal 96kB.

Font

Internal:	6 fonts are preinstalled; Liberation Sans, Liberation Serif, Tahoma, Century Gothic, Arial black and ArabDigit Black. In addition extra fonts can be stored. The system offers full downloadable font support for Windows TrueType fonts. The font ArabDigit Black can only be used for Arabic digits, e.g. time, date and numbers. The other internal fonts can be used to print fixed and variable text e.g. time, date, operator input text, see section 9.1.3.
External:	fonts used in a label that will be treated as fixed data/text. When using external font in the label design program QiC Draw, the actual printable bitmaps of the characters is generated and stored in the label, including the original entered text so that editing in QiC Draw remains possible.

Barcode formats

Australian Post Customer 2, Australian Post Customer 3, Australian Post Redirection, Australian Post Reply Paid, Australian Post Routing, Australian Post Standard Customer, Codabar(2 widths), Codablock-F, Code 11, Code 2 of 5 Data Logic, Code 2 of 5 IATA, Code 2 of 5 Industrial, Code 2 of 5 Matrix, Code 2 of 5, Code 3 of 9 (Code39) Ascii, Code 3 of 9 (Code39), Code 93 Ascii, Code 93, Code128

(Subset A), Code128 (Subset B), Code128 (Subset C), Code128, Data Matrix, Deutsche Post Identcode, Deutsche Post Leitcode, EAN128, EAN13 - 2 digits add on, EAN13 - 5 digits add on, EAN13, EAN-14, EAN8 - 2 digits add on, EAN8 - 5 digits add on, EAN8, Flattermarken, Interleaved 2 of 5, ISBN Code (=EAN13P5), Japanese Postal Code, Korean Postal Authority Code, LOGMARS, MaxiCode, Micro PDF417, MSI code, NVE-18, PDF417 Truncated, PDF417, Pharmacentralnumber, Pharmacode OneTrack, Pharmacode TwoTrack, Planet 12 digits, Planet 14 digits, Plessey code, PostNet-10 (ZIP + 4 + Check digit), PostNet-11 (ZIP + 4 + 2), PostNet-12 (ZIP + 4 + 2 + Check digit), PostNet-5 (ZIP 5 digits), PostNet-6 (ZIP 5 digits + Check digit), PostNet-9 (ZIP + 4), QR-Code, Royal Mail 4 State (RM4SCC), RSS Expanded, RSS Limited, RSS-14 Expanded Stacked, RSS-14 Stacked Omnidirectional, RSS-14 Stacked, RSS-14 Truncated, RSS-14, SSCC18, Telepen Alpha, UCC 128(=EAN128), UPC A - 2 digits add on, UPC A - 5 digits add on, UPC A, UPC E - 2 digits add on, UPC E - 5 digits add on, UPC E, UPC12 Digits (this list contains barcodes available in combination with QiC Draw. The list can vary when using another label design program).

Items

- Graphic: Depending on the label design program used. Generally in jpg, jpeg or bmp format (black/white).
- Dynamic: Number, date, time and shiftcode.
- Operator input: Text, start value of a counter/number, offset of a date.

Label download Through Ethernet or a USB thumbdrive.

Storage capacity The control unit memory size for storing labels is 55MB (approximately 570 labels of the maximum label size).

Appendix B Dimensions

Coding unit 30i	B-2
Coding unit 53i	B-3
Coding unit 107i	B-4
Control unit	B-5
Standard bracket	B-6

Coding unit 30i

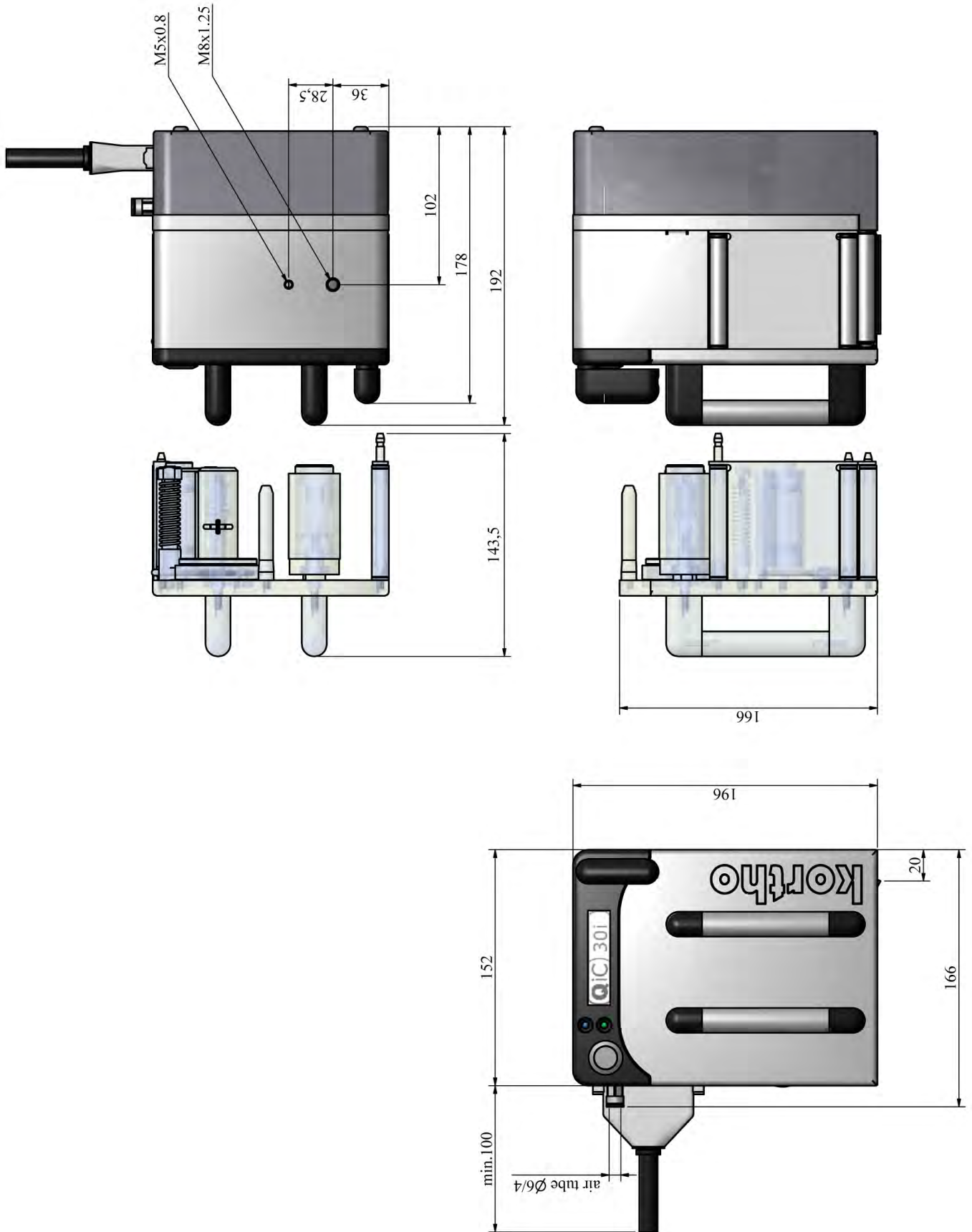

Dimensions are metric [mm]

Coding unit 53i

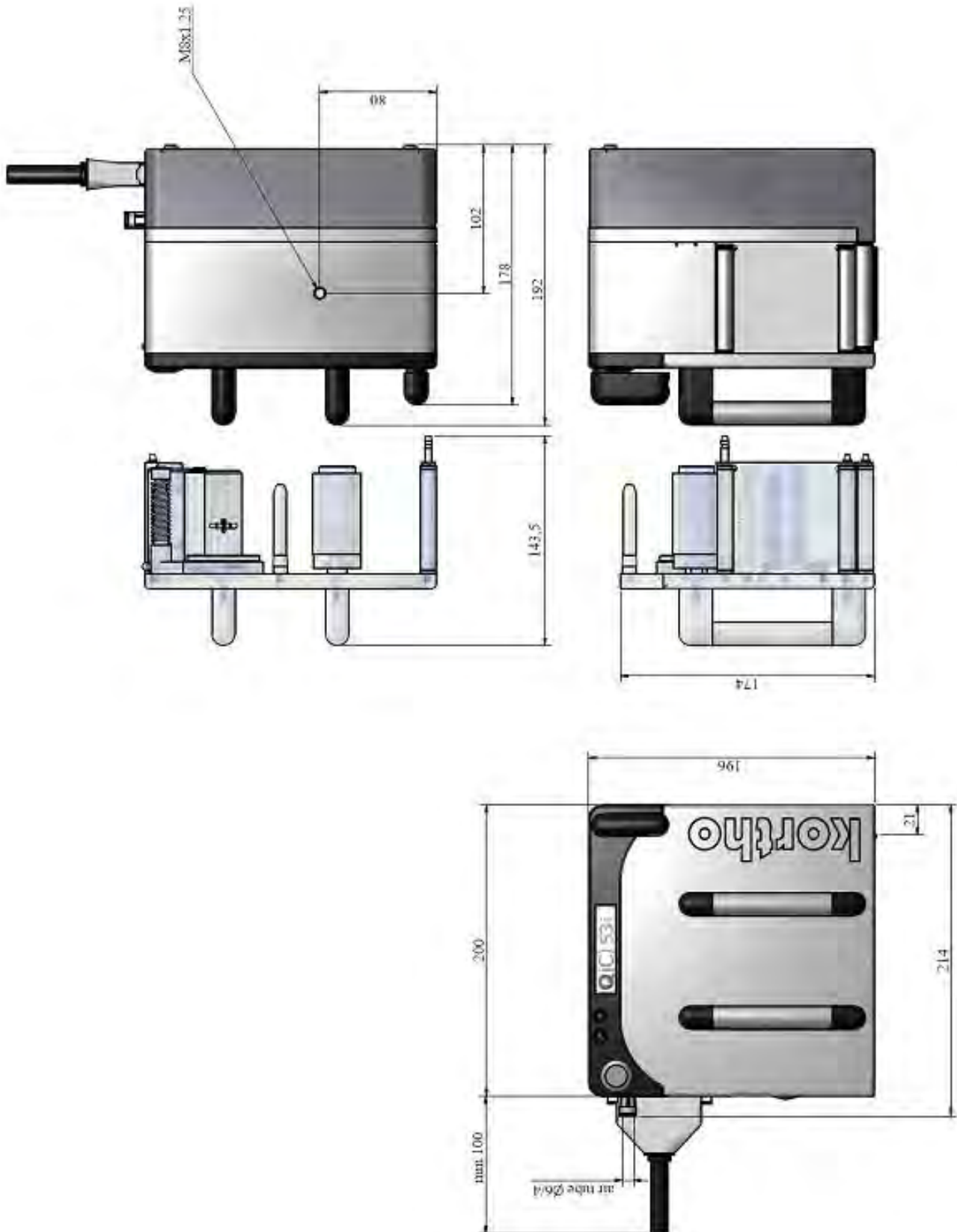

Dimensions are metric [mm]

Coding unit 107i

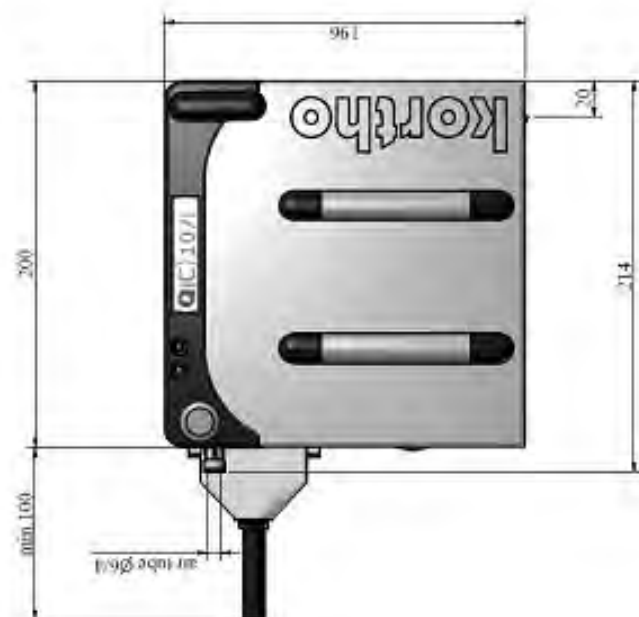
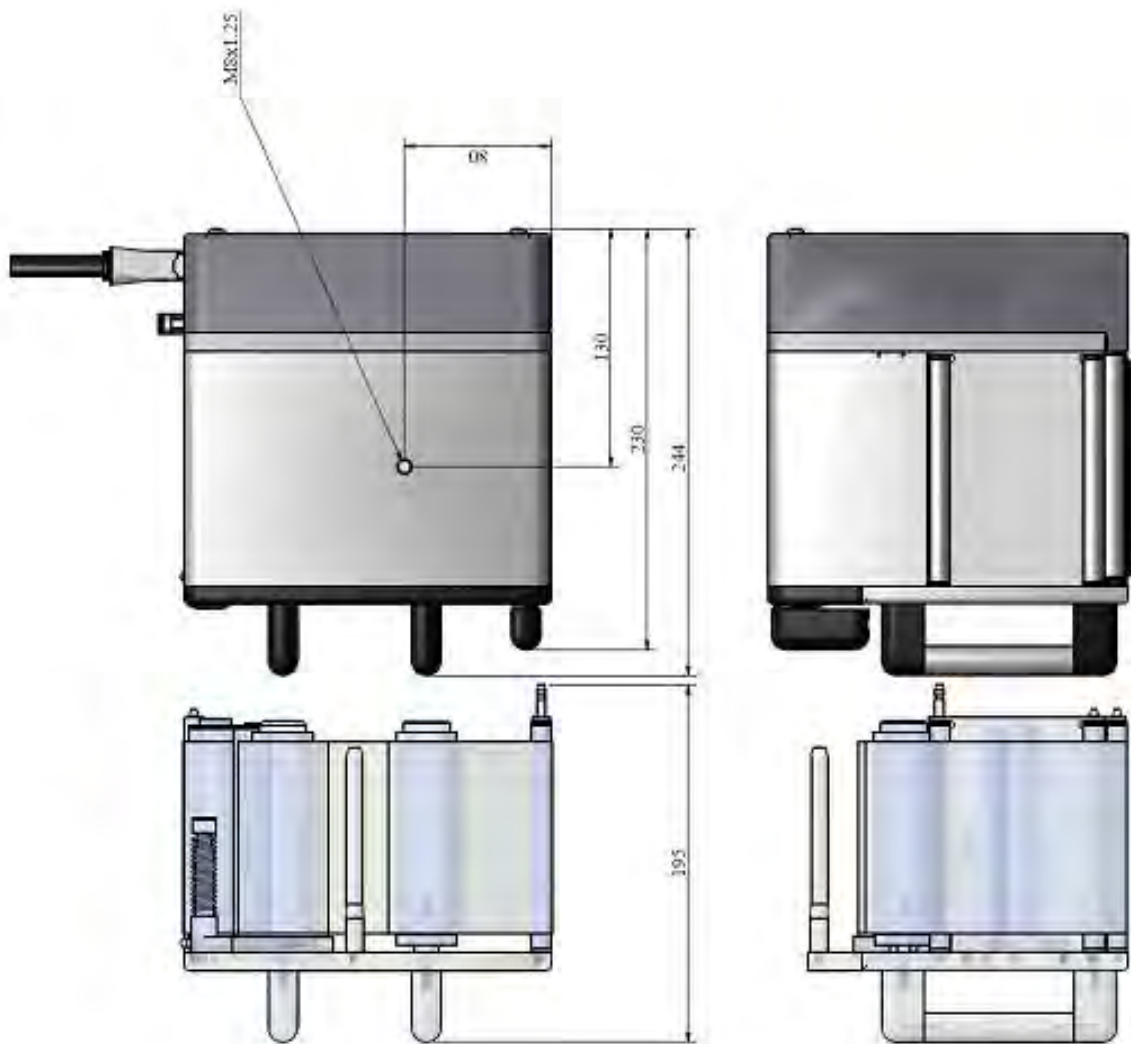

Dimensions are metric [mm]

Control unit

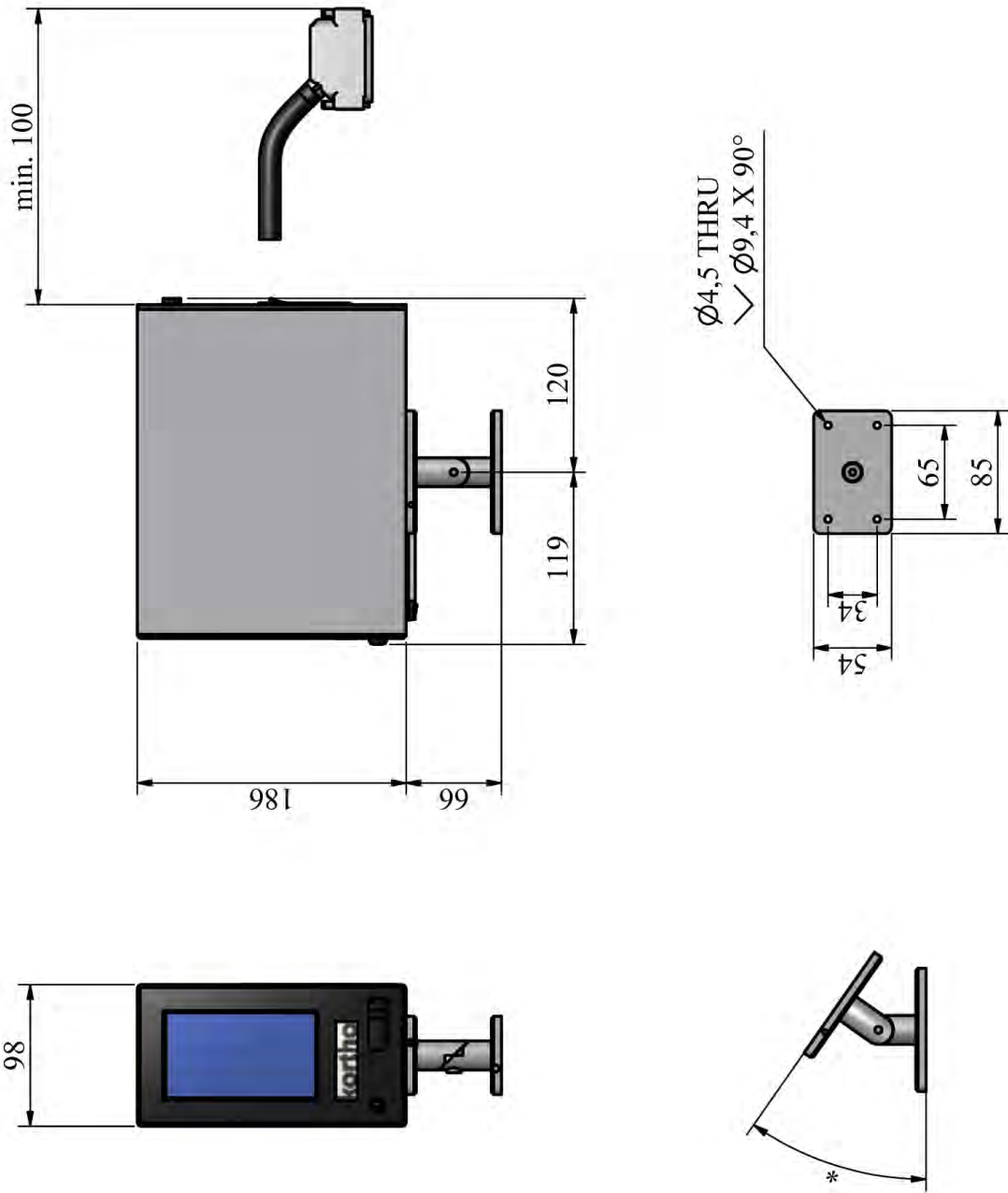

Dimensions are metric [mm]

Standard bracket

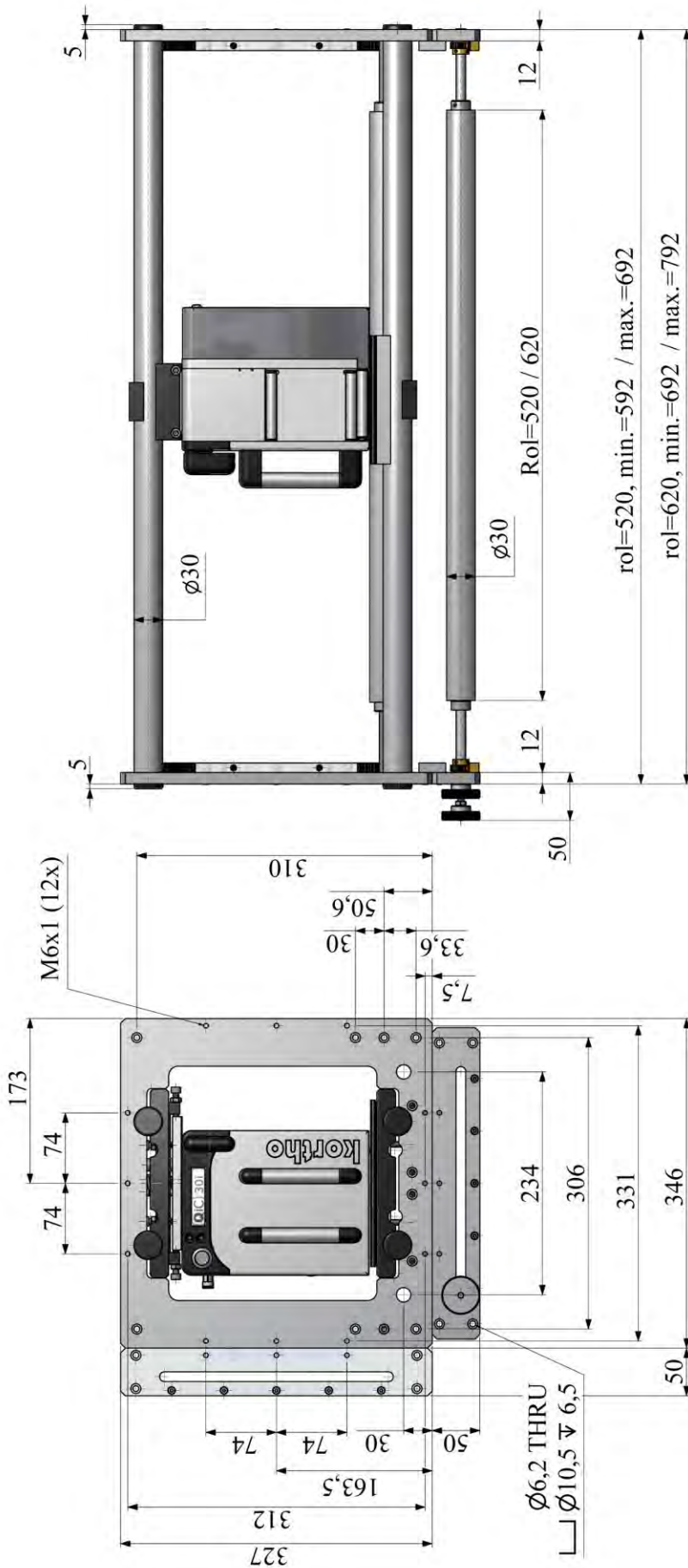

Dimensions are metric [mm]

Appendix C Part lists & illustrations

Coding unit QiC 30i.....	C-2
Coding unit QiC 30i, drawing A	C-2
Coding unit QiC 30i, drawing B	C-4
Magazine QiC 30i	C-6
Printhead cylinder QiC 30i.....	C-8
Coding unit QiC 53i.....	C-10
Coding unit QiC 53i, drawing A	C-10
Coding unit QiC 53i, drawing B	C-12
Magazine QiC 53i	C-14
Printhead cylinder QiC 53i.....	C-16
Coding unit QiC 107i.....	C-18
Coding unit QiC 107i, drawing A	C-18
Coding unit QiC 107i, drawing B	C-20
Magazine QiC 107i.....	C-22
Printhead cylinder QiC 107i.....	C-24
Control unit TsC12	C-26
Control unit TsC12, QiC 30i	C-26
Control unit TsC12, QiC 53i	C-28
Control unit TsC12, QiC 107i	C-30
Standard bracket L=520 and L=620.....	C-32
Standard bracket L=520	C-32
Standard bracket L=620	C-32

Coding unit QiC 30i**Coding unit QiC 30i, drawing A**

816629 Coding unit QiC 30i		
Drawing A		
Line	Part no.	Description
1	165394	Draw spring d=0,45; Dm=7,5; L=14,0
2	165728	Close tolerance screw
3	165871	Printhead QiC 30/53
4	322642	Stub carriage plate QiC
5	325344	Encoderstrip 30i

Line	Part no.	Description
6	815261	Cable internal coding unit QiC
7	815299	PCB coding unit QiC
8	815414	Magazine QiC 30i
9	815678	Reducer 3 bar QiC
10	816254	Heating element D=4, 48V-10W

APPENDIX C, PART LISTS & ILLUSTRATIONS

Coding unit QiC 30i, drawing A

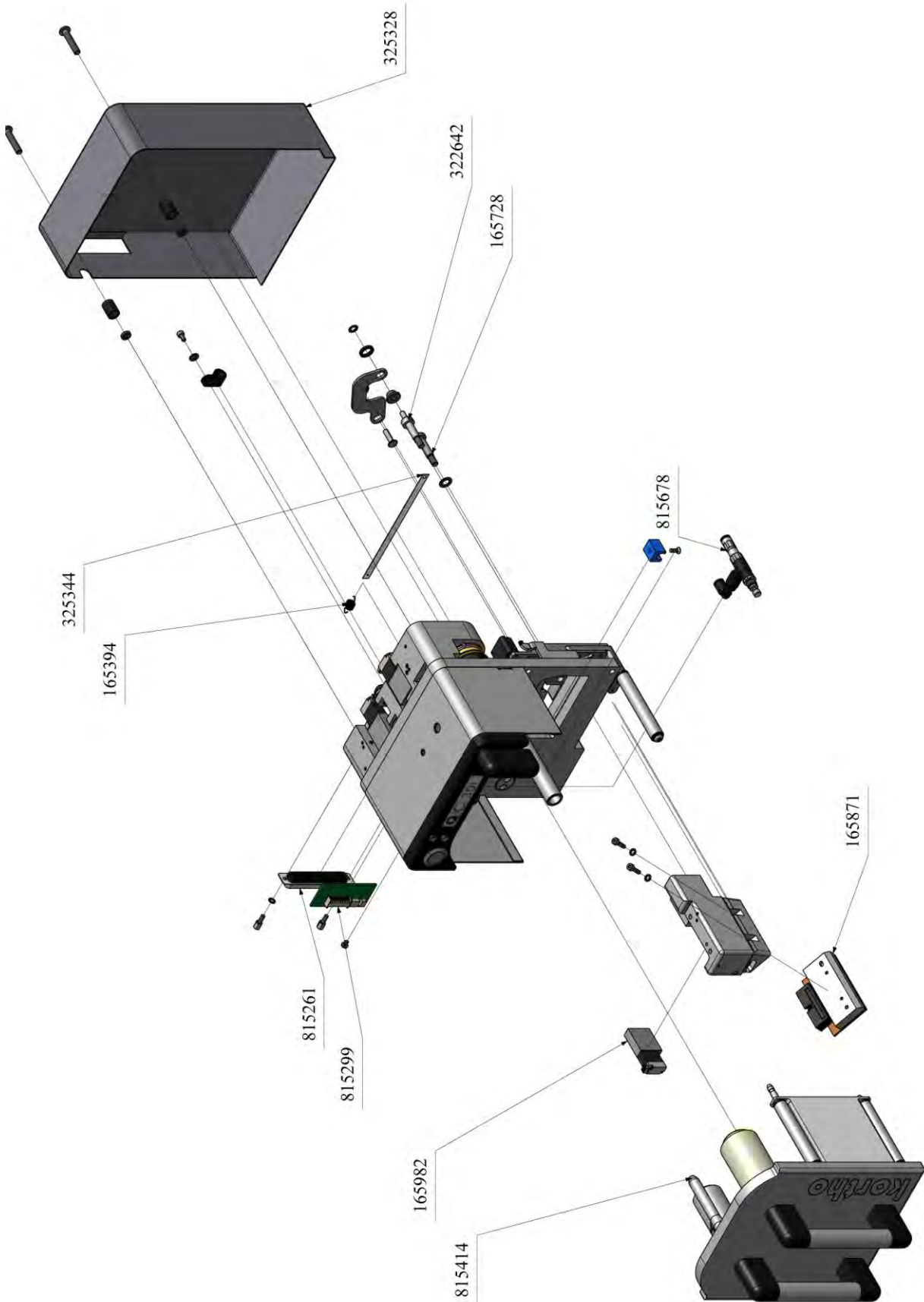

Coding unit QiC 30i, drawing B

816629 Coding unit QiC 30i**Drawing B**

Line	Part no.	Description	Line	Part no.	Description
1	160659	Straight screw coupling M5x6	17	166584	O-ring 18,1x1,6 Viton, green
2	163879	Outer safety ring D=6, St.St.	18	167102	Nut M4 St.St.
3	165238	Ball bearing 19/10x5	19	167297	Outer safety ring with cap D=4, St.
4	165295	Collar bearing bronze 12/08x04	20	322712	Wire tension wheel QiC
5	165311	LED tri colour, 2VDC, QiC	21	325357	Transfer rod QiC 30
6	165324	LED blue, 5VDC, QiC	22	325372	Guard magazine QiC 30
7	165349	Wagen lineair rail QiC	23	815301	Clutch QiC
8	165448	Push button QiC	24	815554	Cable clutch QiC 30
9	165588	Inner safety ring 14x1,0 St.St.	25	815567	Cable tension QiC 30
10	165744	Outer safety ring D=4, St.St.	26	815595	Endblock clutch QiC 30
11	165801	O-ring 4,0x1,0 NBR	27	815608	Endblock tension QiC 30
12	165814	O-ring 28,0x1,0 NBR	28	815611	Rolle foilguide QiC 30/53
13	165839	O-ring 12,0x1,0 NBR	29	815637	Encoder disc
14	165925	Timing belt B=6, Z=50, QiC 30	30	815681	Sensor encoder strip QiC
15	165982	Solenoid valve QiC	31	815917	Cable magazine/switch QiC 30
16	166052	Joint ring QiC			

APPENDIX C, PART LISTS & ILLUSTRATIONS

Coding unit QiC 30i, drawing B

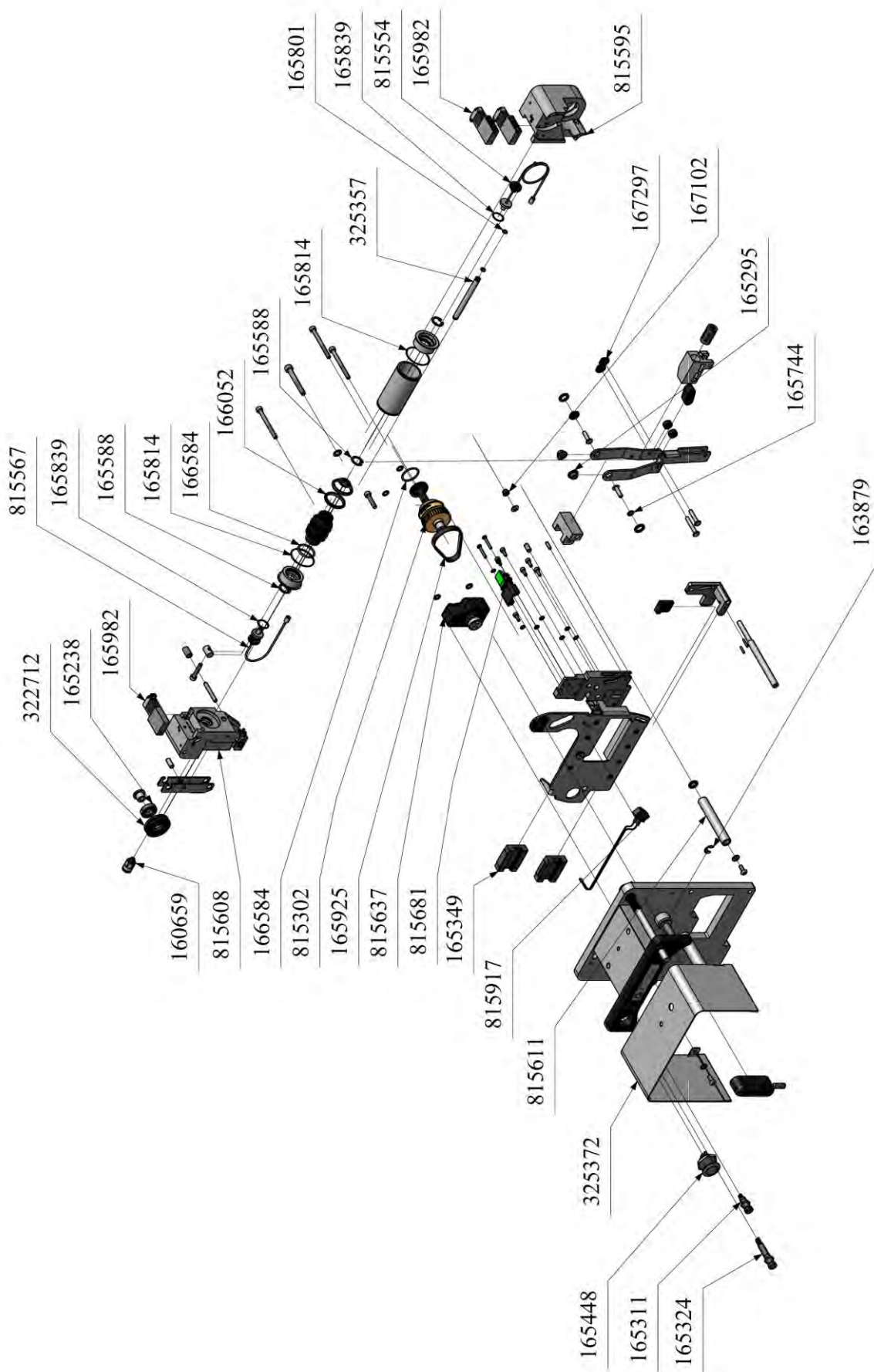

Magazine QiC 30i

815414 Magazine QiC 30i					
Line	Part no.	Description	Line	Part no.	Description
1	163879	Outer safety ring D=6, St.St.	11	322767	Shaft spool take-up QiC
2	165378	Compr. Spring D=1,6; Dm=13,2; L= 19,5	12	322849	Disc felt QiC
3	165714	Nylock nut M5	13	323005	L-piece magazine QiC
4	165897	O-ring 11,0x1,5 Viton	14	323285	Disc winding roll QiC
5	166078	Beraing 15/5x2	15	323957	Shaft spool feed-off QiC 30/53
6	166081	Disc bearing 15/5x2	16	815357	Roller foil encoder QiC 30/53
7	166218	Spring encoder magazine	17	815372	Spool take-up QiC 30/53
8	166221	Torsion spring magazine QiC	18	815398	Spool feed-off QiC 30/53
9	321984	Rol encoder QiC 30/53	19	815611	Roller foilguide QiC 30/53
10	322741	Disc PTFE QiC			

APPENDIX C, PART LISTS & ILLUSTRATIONS

Magazine QiC 30i

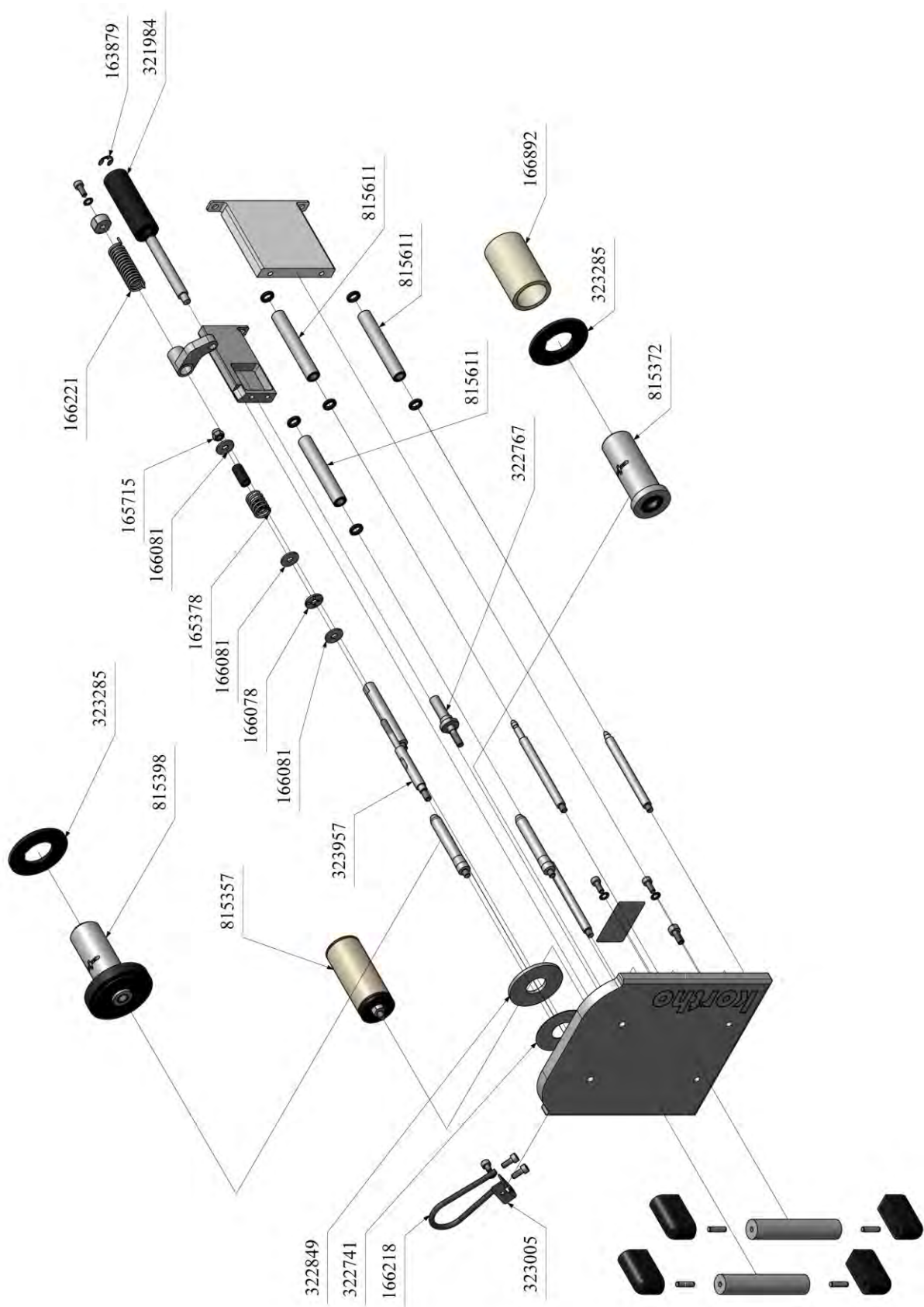

Printhead cylinder QiC 30i

815328 Printhead cilinder QiC 30i		
Line	Part no.	Description
1	165772	O-ring 8,0x1,5 Viton
2	165897	O-ring 11,0x1,5 Viton

Line	Part no.	Description
3	165982	Solenoid valve QiC

APPENDIX C, PART LISTS & ILLUSTRATIONS

Printhead cylinder QiC 30i

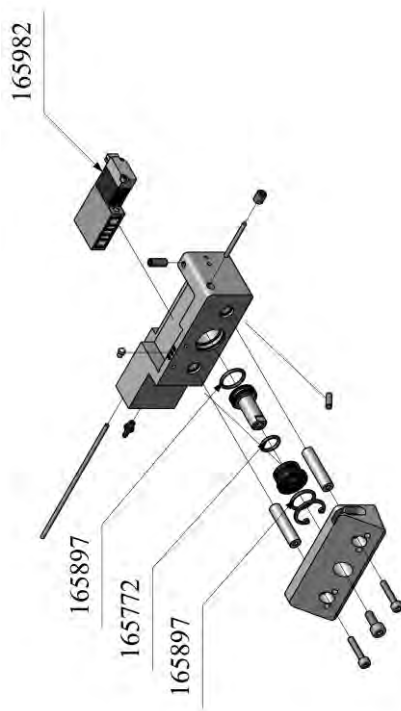

Coding unit QiC 53i

Coding unit QiC 53i, drawing A

816311 Coding unit QiC 53i					
Drawing A					
Line	Part no.	Description	Line	Part no.	Description
1	165394	Draw spring d=0,45; Dm=7,5; L=14,0	7	815261	Cable internal coding unit QiC
2	165728	Close tolerance screw	8	815299	PCB coding unit QiC
3	165871	Printhead QiC 30/53	9	815427	Magazine QiC 53i
4	322347	Cover QiC 53/107	10	815678	Reducer 3 bar QiC
5	322642	Stub carriage plate QiC	11	816254	Heating element D=4, 48V-10W
6	322907	Endocerstrip QiC 53/107			

APPENDIX C, PART LISTS & ILLUSTRATIONS

Coding unit QiC 53i, drawing A

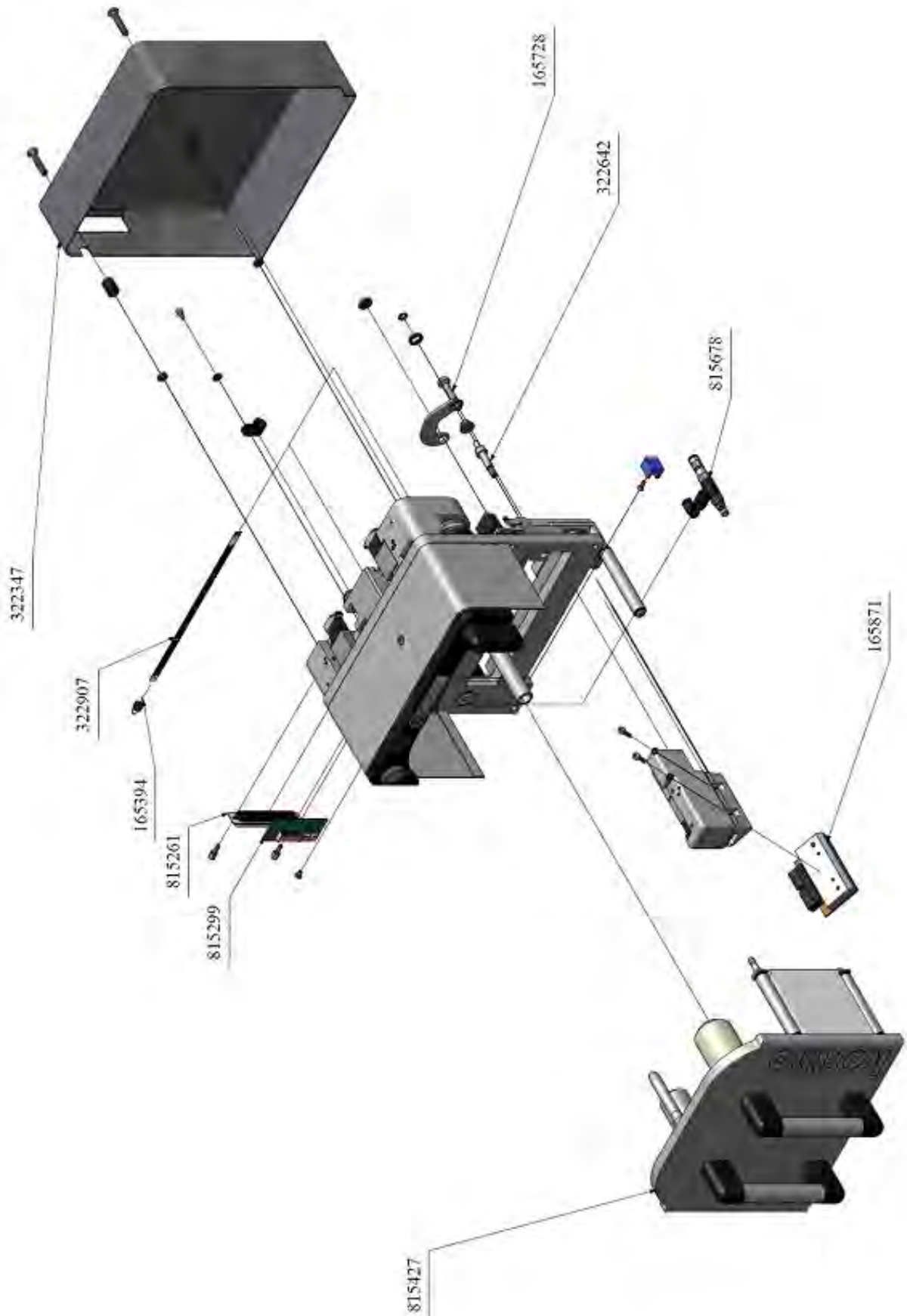

Coding unit QiC 53i, drawing B

816311 Coding unit QiC 53i			816311 Coding unit QiC 53i		
Drawing B			Drawing B		
Line	Part no.	Description	Line	Part no.	Description
1	160659	Straight screw coupling M5x6	16	167102	Nut M4 St.St.
2	163879	Outer safety ring D=6, St.St.	17	167297	Outer safety ring with cap D=4, St.
3	165238	Ball bearing 19/10x5	18	322474	Transfer rod QiC 53/107
4	165311	LED tri colour, 2VDC, QiC	19	322712	Wire tension wheel QiC
5	165324	LED blue, 5VDC, QiC	20	323832	Guard magazine QiC 53
6	165349	Wagen lineair rail QiC	21	815302	Clutch QiC
7	165419	Timing belt B=6; L=63;, QiC 53/107	22	815579	Cable clutch QiC 53/107
8	165448	Push button QiC	23	815582	Cable tension QiC 53/107
9	165588	Inner safety ring 14x1,0 St.St.	24	815595	Endblock clutch QiC 30
10	165801	O-ring 4,0x1,0 NBR	25	815608	Endblock tension QiC 30
11	165814	O-ring 28,0x1,0 NBR	26	815611	Roller foilguide QiC 30/53
12	165839	O-ring 12,0x1,0 NBR	27	815637	Encoder disc
13	165982	Solenoid valve QiC	28	815681	Sensor encoder strip QiC
14	166052	Joint ring QiC	29	815917	Cable magazine/switch QiC 53/107
15	166584	O-ring 18,1x1,6 Viton, green			

APPENDIX C, PART LISTS & ILLUSTRATIONS

Coding unit QiC 53i, drawing B

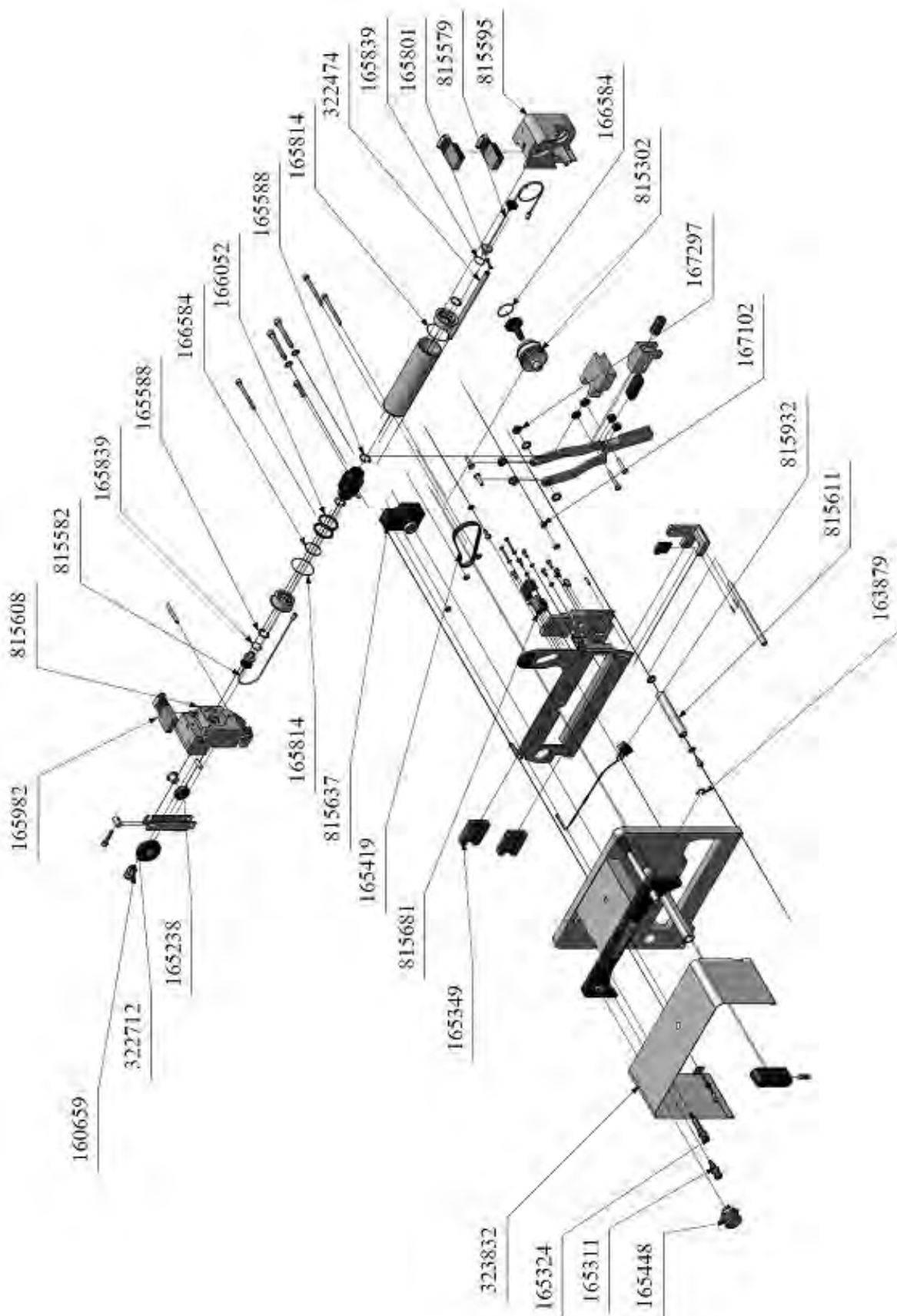

Magazine QiC 53i

815427 Magazine QiC 53i			815427 Magazine QiC 53i		
Line	Part no.	Description	Line	Part no.	Description
1	163879	Outer safety ring D=6, St.St.	10	322767	Shaft spool take-up QiC
2	165378	Compr. Spring D=1,6; Dm=13,2; L= 19,5	11	322849	Disc felt QiC
3	166078	Bearing 15/5x2	12	323285	Disc winding roll QiC
4	166081	Disc bearing 15/5x2	13	323957	Shaft spool feed-off QiC 30/53
5	166218	Spring encoder magazine	14	324138	L-piece magazine QiC 53/107
6	166221	Torsion spring magazine QiC	15	815357	Roller foil encoder QiC 30/53
7	166892	Core QiC 30/53	16	815372	Spool take-up QiC 30/53
8	321984	Rol encoder QiC 30/53	17	815398	Spool feed-off QiC 30/53
9	322741	Disc PTFE QiC	18	815611	Roller foilguide QiC 30/53

APPENDIX C, PART LISTS & ILLUSTRATIONS

Magazine QiC 53i Magazine QiC 30i

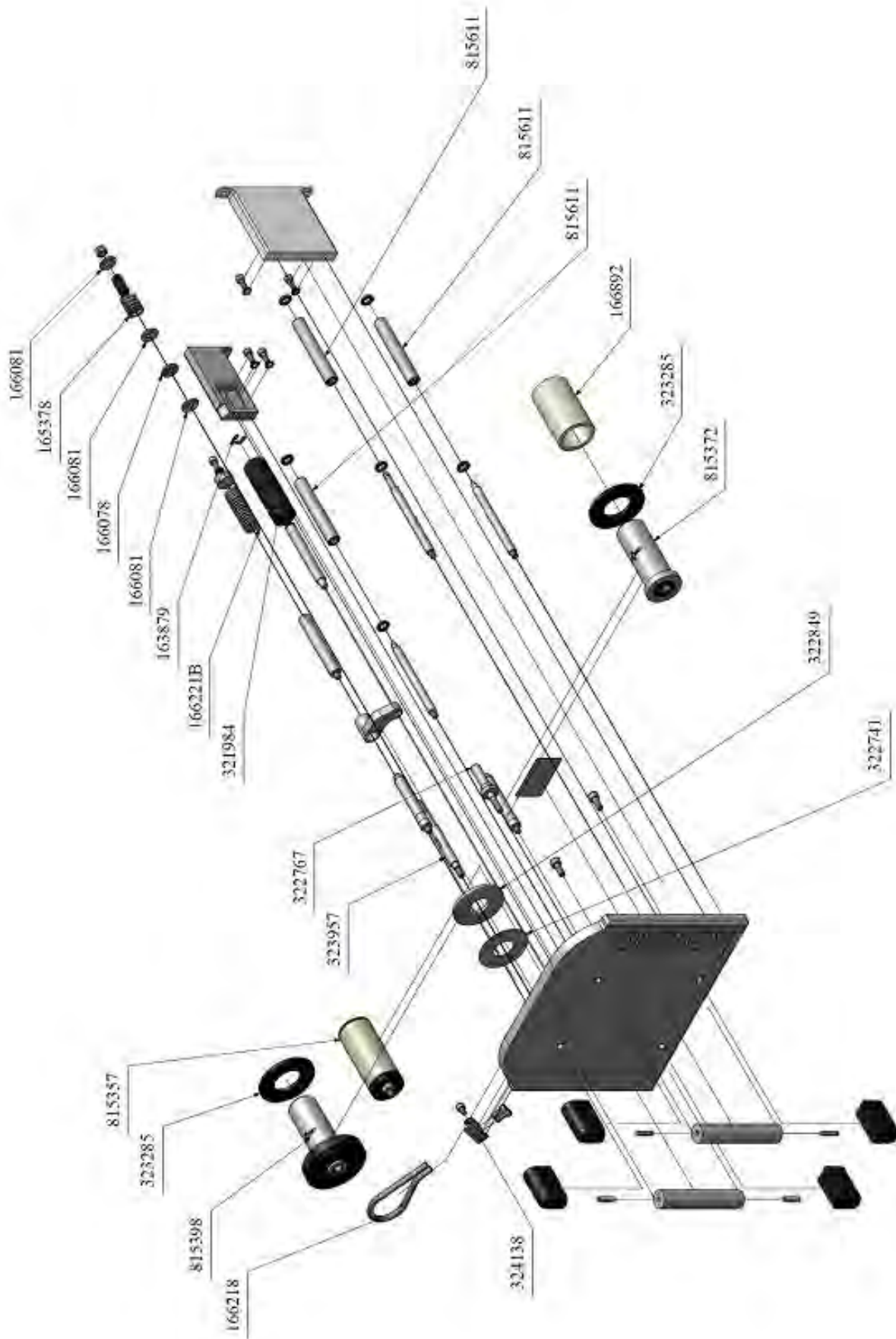

Printhead cylinder QiC 53i

815328 Printhead cilinder QiC 53i		
Line	Part no.	Description
1	165772	O-ring 8,0x1,5 Viton
2	165897	O-ring 11,0x1,5 Viton

Line	Part no.	Description
3	165982	Solenoid valve QiC

APPENDIX C, PART LISTS & ILLUSTRATIONS

Printhead cylinder QiC 53i

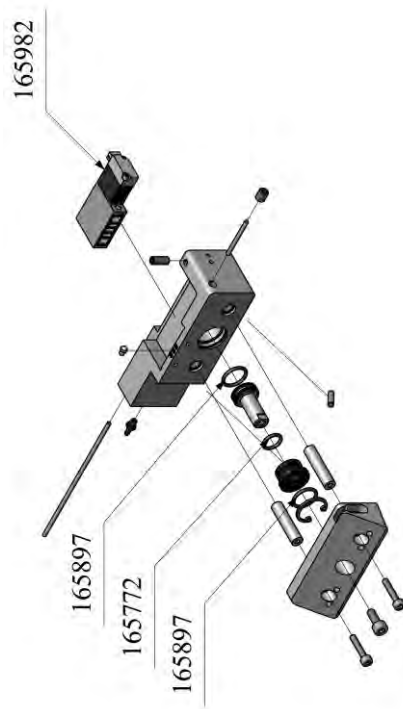

Coding unit QiC 107i**Coding unit QiC 107i, drawing A**

815722 Coding unit QiC 107i		
Drawing A		
Line	Part no.	Description
1	165394	Draw spring d=0,45; Dm=7,5; L=14,0
2	165422	Printhead QiC 107
3	165728	Close tolerance screw
4	322347	Cover QiC 53/107
5	322642	Stub carriage plate QiC
6	322907	Encoderstrip QiC 53/107

Line	Part no.	Description
7	815261	Cable internal coding unit QiC
8	815299	PCB coding unit QiC
9	815439	Magazine QiC 107
10	815678	Reducer 3 bar QiC
11	816254	Heating element D=4, 48V-10W

APPENDIX C, PART LISTS & ILLUSTRATIONS

Coding unit QiC 107i, drawing A

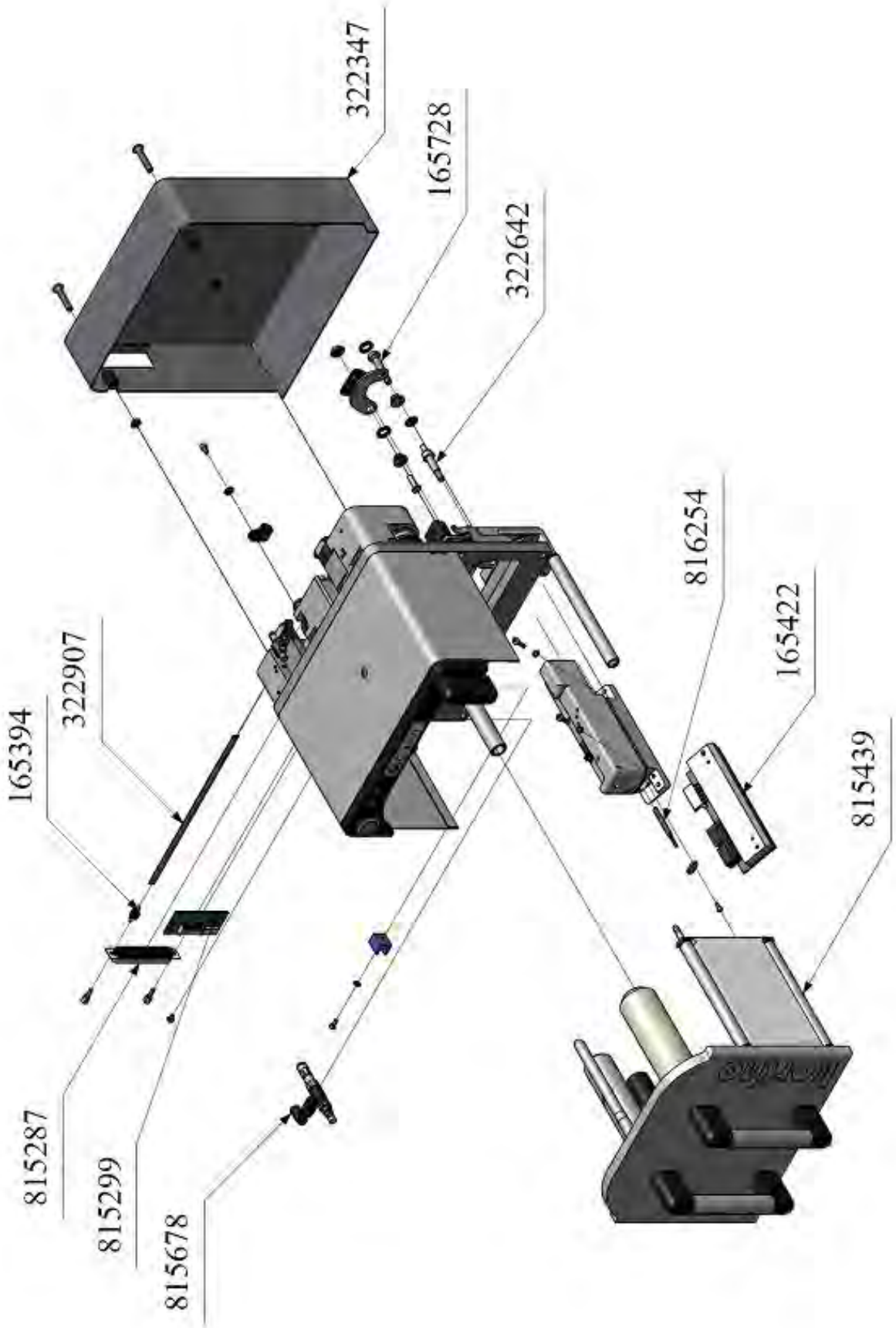

Coding unit QiC 107i, drawing B

815497 Coding unit QiC 107i			815497 Coding unit QiC 107i		
Drawing B			Drawing B		
Line	Part no.	Description	Line	Part no.	Description
1	160659	Straight screw coupling M5x6	16	167102	Nut M4 St.St.
2	163879	Outer safety ring D=6, St.St.	17	167297	Outer safety ring with cap D=4, St.
3	165238	Ball bearing 19/10x5	18	322474	Transfer rod QiC 53/107
4	165311	LED tri colour, 2VDC, QiC	19	322712	Wire tension wheel QiC
5	165324	LED blue, 5VDC, QiC	20	323651	Guard magazine QiC 107
6	165349	Wagen lineair rail QiC	21	815302	Clutch QiC
7	165419	Timing belt B=6, L=63, QiC 53/107	22	815579	Cable clutch QiC 53/107
8	165448	Push button QiC	23	815582	Cable tension QiC 53/107
9	165588	Inner safety ring 14x1,0 St.St.	24	815595	Endblock clutch QiC 30
10	165801	O-ring 4,0x1,0 NBR	25	815608	Endblock tension QiC 30
11	165814	O-ring 28,0x1,0 NBR	26	815624	Roller foilguide QiC 107
12	165839	O-ring 12,0x1,0 NBR	27	815637	Encoder disc
13	165982	Solenoid valve QiC	28	815681	Sensor encoder strip QiC
14	166052	Joint ring QiC	29	815932	Cable magazine/switch QiC 53/107
15	166584	O-ring 18,1x1,6 Viton, green			

APPENDIX C, PART LISTS & ILLUSTRATIONS

Coding unit QiC 107i, drawing B

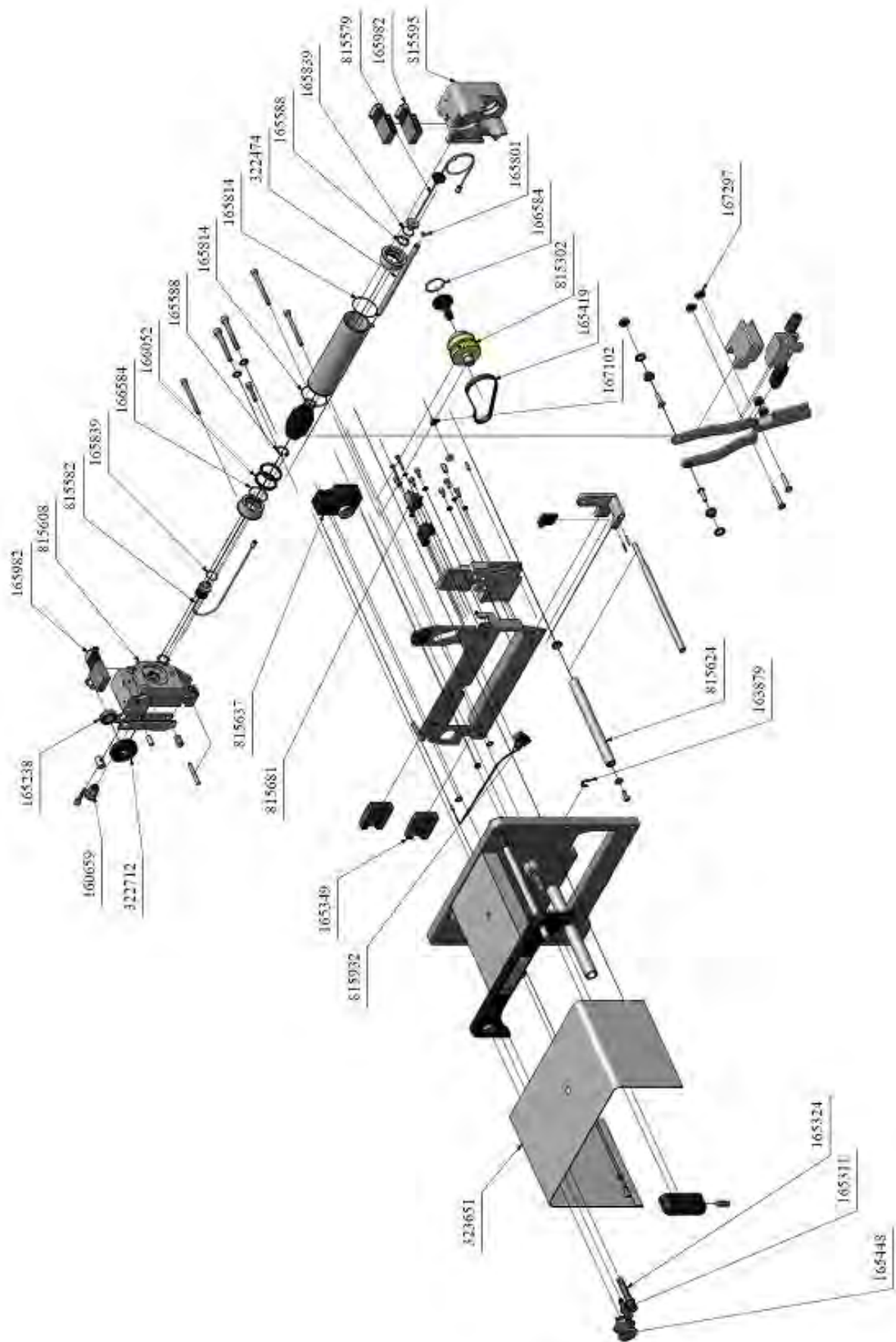

Magazine QiC 107i

815439 Magazine QiC 107i			815439 Magazine QiC 107i		
Line	Part no.	Description	Line	Part no.	Description
1	163879	Outer safety ring D=6, St.St.	10	322837	Shaft spool feed-off QiC 107
2	165378	Compr. spring D=1,6;Dm=13,2;L= 19,5	11	322849	Disc felt QiC
3	166078	Beraing 15/5x2	12	323314	Rol encoder QiC 107
4	166081	Disc bearing 15/5x2	13	323005	L-piece magazine QiC
5	166218	Spring encoder magazine	14	815369	Roller foil encoder QiC 107
6	166221	Torsion spring magazine QiC	15	815385	Spool take-up QiC 107
7	167255	Core QiC 107	16	815401	Spool feed-off QiC 107
8	322741	Disc PTFE QiC	17	815624	Roller foilguide QiC 107
9	322767	Shaft spool take-up QiC			

APPENDIX C, PART LISTS & ILLUSTRATIONS

Magazine QiC 107i

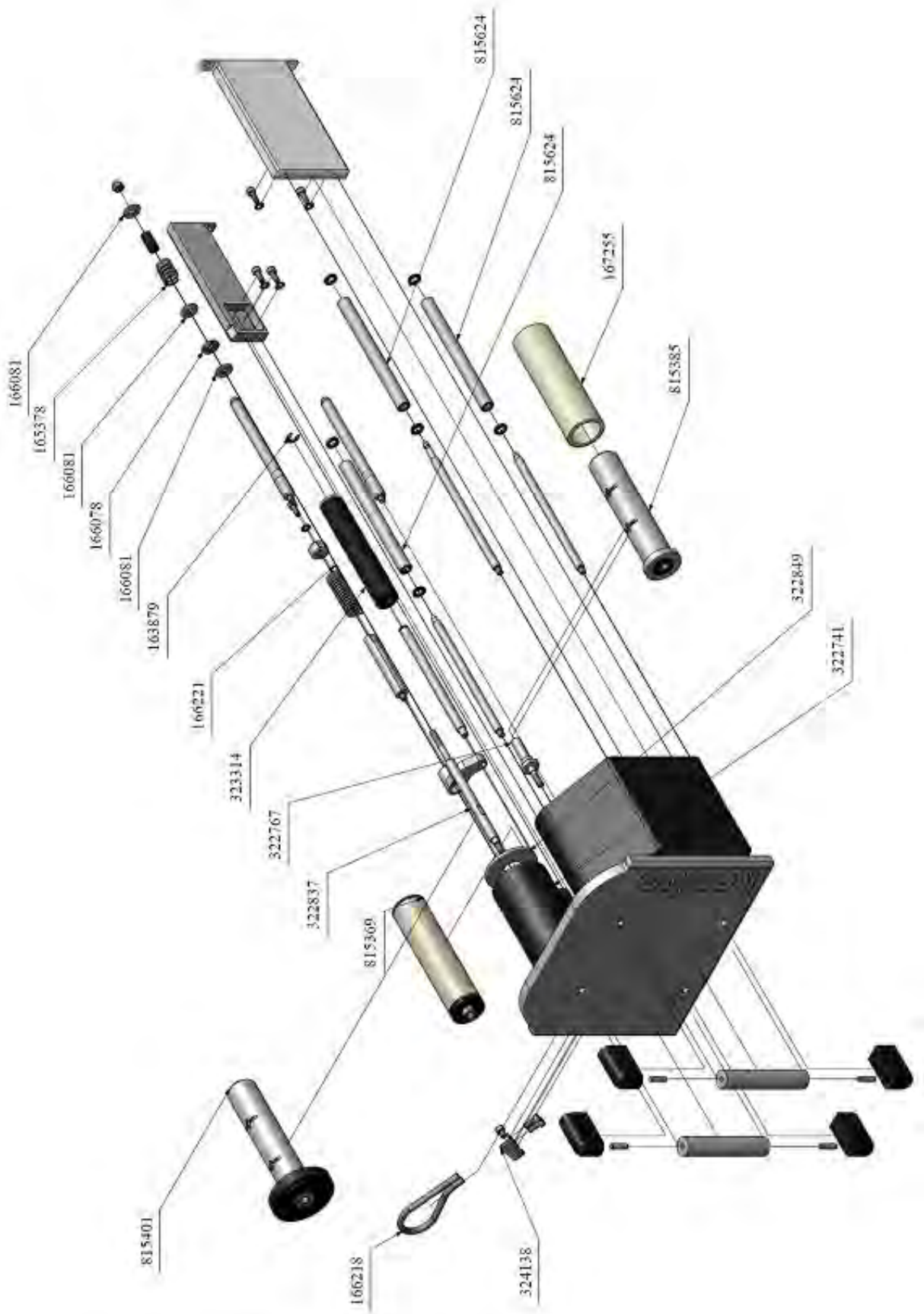

Printhead cylinder QiC 107i

815315 Printhead cilinder QiC 107i		
Line	Part no.	Description
1	165772	O-ring 8,0x1,5 Viton
2	165897	O-ring 11,0x1,5 Viton

Line	Part no.	Description
3	165982	Solenoid valve QiC

APPENDIX C, PART LISTS & ILLUSTRATIONS

Printhead cylinder QiC 107i

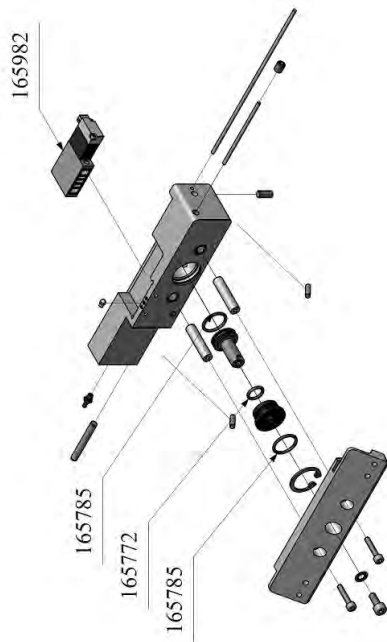

Control unit TsC12

Control unit TsC12, QiC 30i

817332 Control box TsC12, QiC 30i					
Line	Part no.	Description	Line	Part no.	Description
1	154178	Fuse 0,5A	13	325735	Gasket TsC12
2	155972	Fuse 3,15A	14	323132	Flap USB CB TsC26
3	166135	Stylus	15	815891	USB connector TsC12 QiC
4	166275	Power supply 48V	16	816015	Support controlbox TsC8
5	166682	Transistor clip TsC26	17	816925	Main cable TsC12, L=2,5
6	166695	Isolation strip TsC26	18	816769	Cable intern encoder QiC
7	167172	LED green, 24VDC, QiC	19	817049	Power supply 5/12/24 VDC, QiC
8	167185	Fuse holder panel, QiC	20	817052	Cable power supply/PX2 TsC8
9	167971	Touch panel TsC12	21	817065	Cable power supply/Filter QiC
10	167984	PCB TX28, TsC12	22	817399	Serieel cable TsC12
11	168054	Filter control box 3A	23	817822	CCU PX2 incl. software
12	322041	Gasket cover TsC8			

APPENDIX C, PART LISTS & ILLUSTRATIONS

Control unit TsC12, QiC 30i

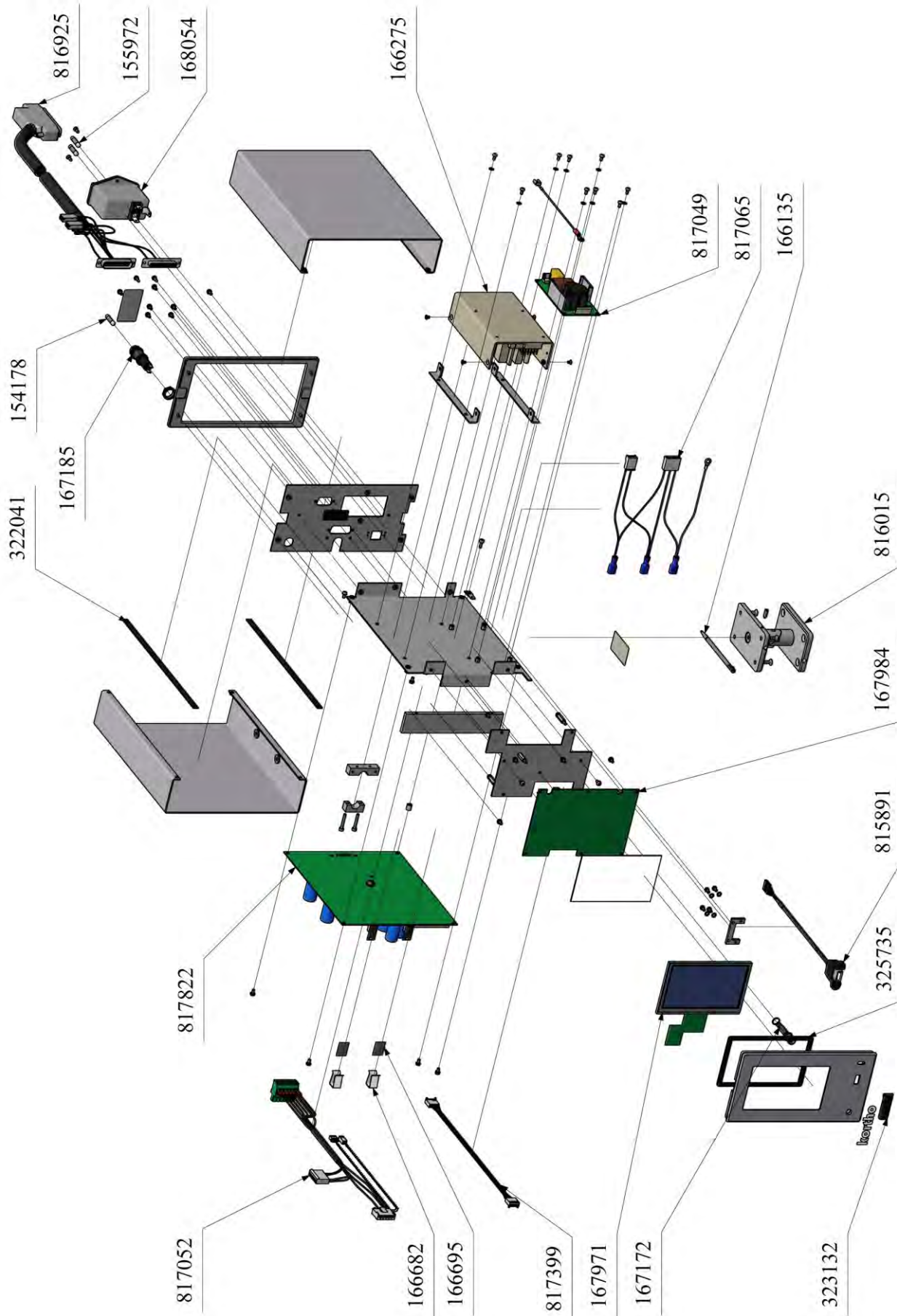

Control unit TsC12, QiC 53i

818242 Control box TsC12, QiC 53i					
Line	Part no.	Description	Line	Part no.	Description
1	154178	Fuse 0,5A	13	325735	Gasket TsC12
2	155972	Fuse 3,15A	14	323132	Flap USB CB TsC26
3	166135	Stylus	15	815891	USB connector TsC12 QiC
4	166275	Power supply 48V	16	816015	Support controlbox TsC8
5	166682	Transistor clip TsC26	17	816925	Main cable TsC12, L=2,5
6	166695	Isolation strip TsC26	18	816769	Cable intern encoder QiC
7	167172	LED green, 24VDC, QiC	19	817049	Power supply 5/12/24 VDC, QiC
8	167185	Fuse holder panel, QiC	20	817052	Cable power supply/PX2 TsC8
9	167971	Touch panel TsC12	21	817065	Cable power supply/Filter QiC
10	167984	PCB TX28, TsC12	22	817399	Serieel cable TsC12
11	168054	Filter control box 3A	23	817822	CCU PX2 incl. software TsC12
12	322041	Gasket cover TsC8			

APPENDIX C, PART LISTS & ILLUSTRATIONS

Control unit TsC12, QiC 53i

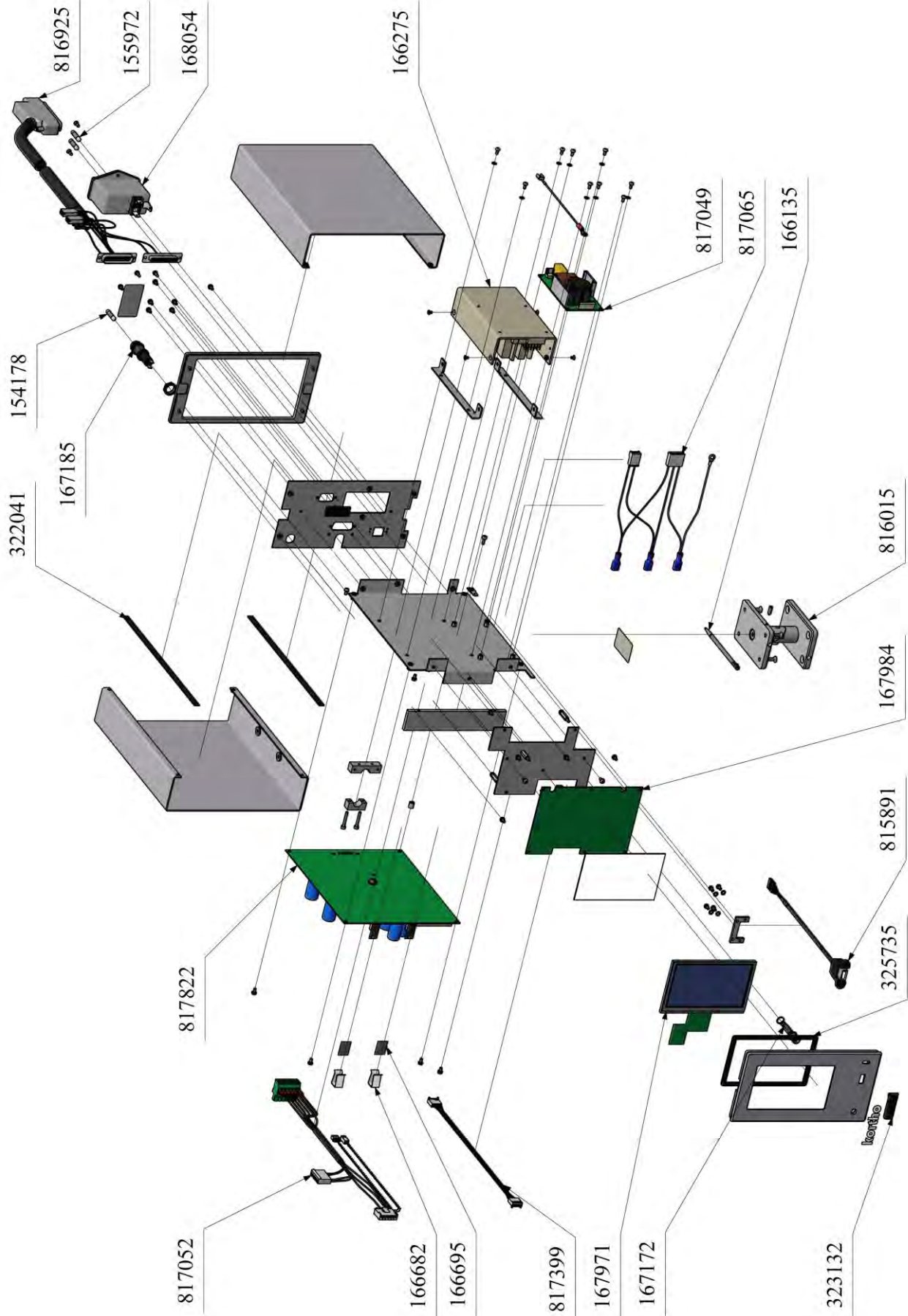

Control unit TsC12, QiC 107i

818255 Control box TsC12, QiC 107i					
Line	Part no.	Description	Line	Part no.	Description
1	154178	Fuse 0,5A	13	325735	Gasket TsC12
2	155972	Fuse 3,15A	14	323132	Flap USB CB TsC26
3	166135	Stylus	15	815891	USB connector TsC12 QiC
4	166275	Power supply 48V	16	816015	Support controlbox TsC8
5	166682	Transistor clip TsC26	17	817822	CCU PX2 incl. software TsC12
6	166695	Isolation strip TsC26	18	816769	Cable intern encoder QiC
7	167172	LED green, 24VDC, QiC	19	817049	Power supply 5/12/24 VDC, QiC
8	167185	Fuse holder panel, QiC	20	817052	Cable power supply/PX2 TsC8
9	167971	Touch panel TsC12	21	817065	Cable power supply/Filter QiC
10	167984	PCB TX28, TsC12	22	817399	Serieel cable TsC12
11	168054	Filter control box 3A	23	818268	Main cable TsC12, 107i
12	322041	Gasket cover TsC8			

APPENDIX C, PART LISTS & ILLUSTRATIONS

Control unit TsC12, QiC 107i

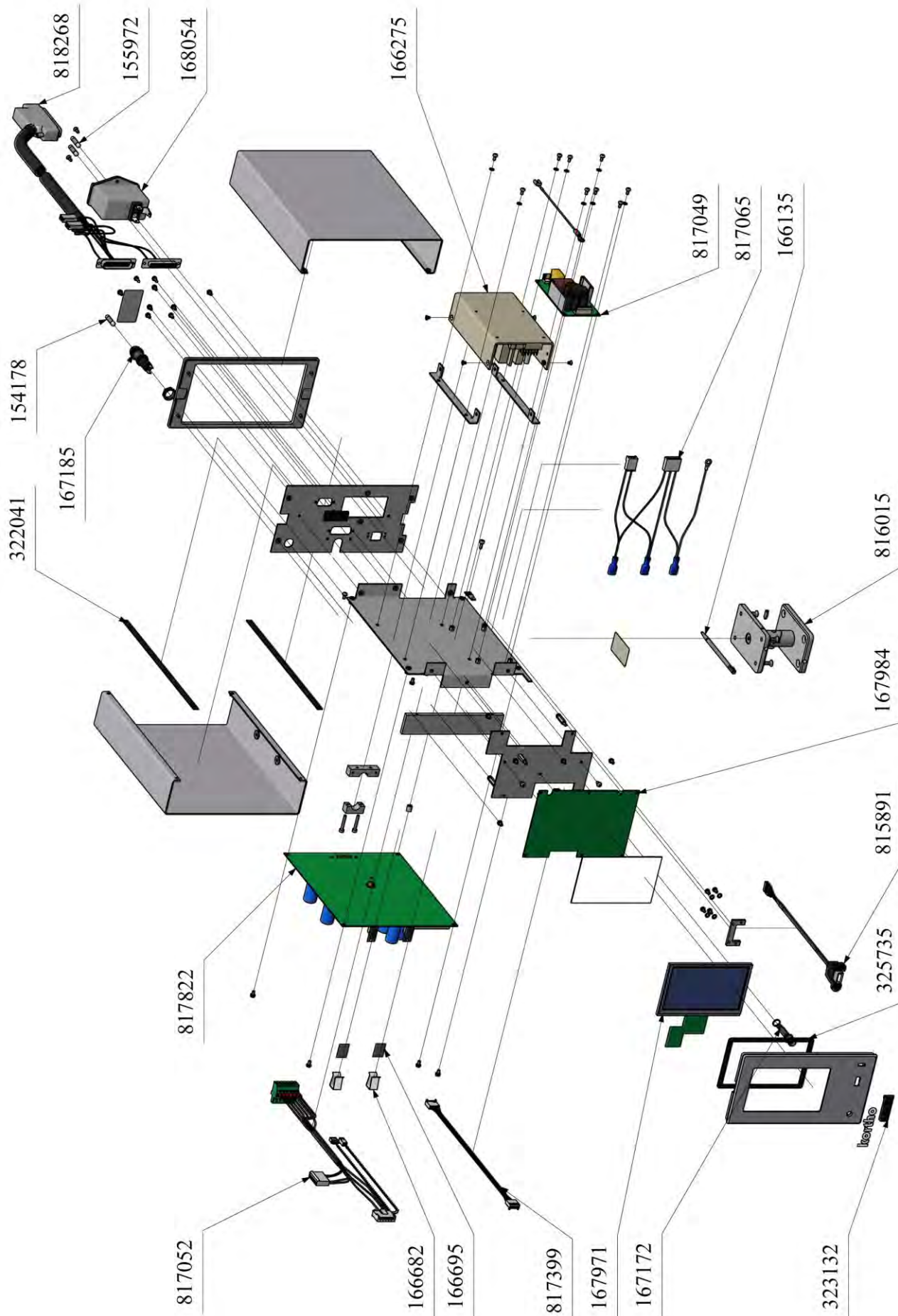

Standard bracket L=520 and L=620

Standard bracket L=520

-----			Bracket L=520		
Line	Part no.	Description	Line	Part no.	Description
1	324771	St.St.tube D=30, L=520 support QiC	6	817247	Roll complete L=520, QiC i/c
2	816645	Roll foil-adjustment L= 520 support QiC i/c	7	817262	Strip QiC support QiC
3	817107	Set frontplate support QiC	Spare part / replacement part		
4	817119	Set counter pressure plate 175x135	8	817081	Counter pressure plate 175x135 QiC i
5	817122	Set adjustment block support QiC			

Standard bracket L=620

-----			Bracket L=620		
Line	Part no.	Description	Line	Part no.	Description
1	324714	St.St.tube D=30, L=620 support QiC	6	817259	Roll complete L=620, QiC i/c
2	816661	Roll foil-adjustment L=620 support QiC i/c	7	817262	Strip QiC support QiC
3	817107	Set frontplate support QiC	Spare part / replacement part		
4	817119	Set counter pressure plate 175x135	8	817081	Counter pressure plate 175x135 QiC i
5	817122	Set adjustment block support QiC			

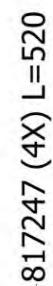
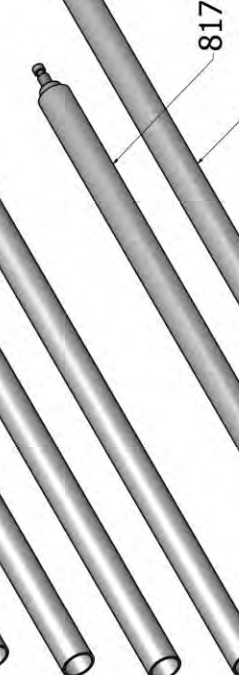
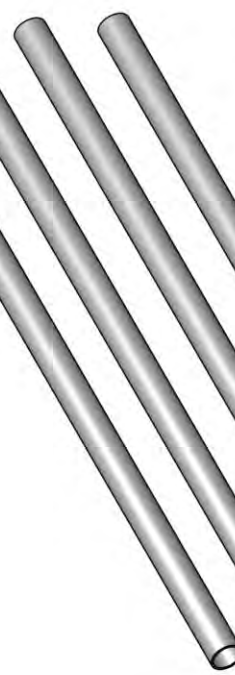
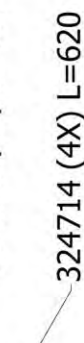

Appendix D Connections

Control unit Connector Plate.....	D-2
X3 Schematic diagram (input)	D-3
X3 Schematic diagram (output)	D-4
X3 Circuit diagram (input)	D-5
X3 Circuit diagram (output).....	D-6
X3 Schematics diagram User	D-7
Pneumatic circuit diagram 30i/53i/107i.....	D-8

Control unit Connector Plate

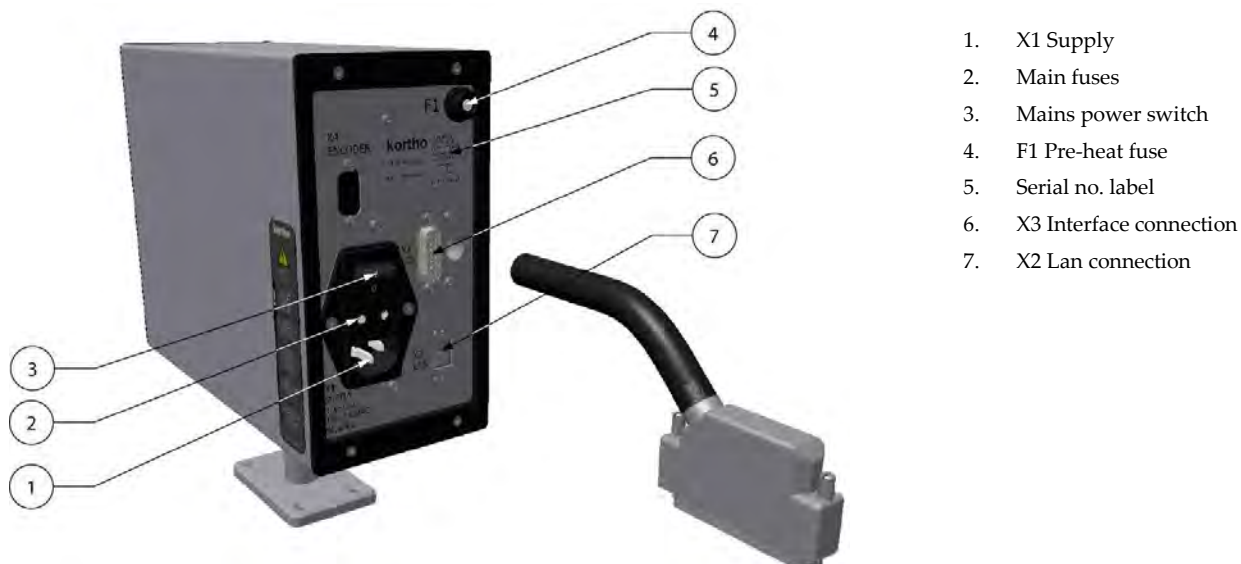

1. X1 Supply
2. Main fuses
3. Mains power switch
4. F1 Pre-heat fuse
5. Serial no. label
6. X3 Interface connection
7. X2 Lan connection

Item	Description	Connector type
X1	Mains Supply with switch and 2 fuses	3,15A (T)
X2	LAN connection	RJ45, socket
X3	Interface connection (input/output)	HD 26-ways, socket
X4	Encoder (not present at 30i printer)	
F1	Preheat fuse	500mA (F)
LABEL	Partnumber, serialnumber and mains supply specification	

X3 Schematic diagram (input)

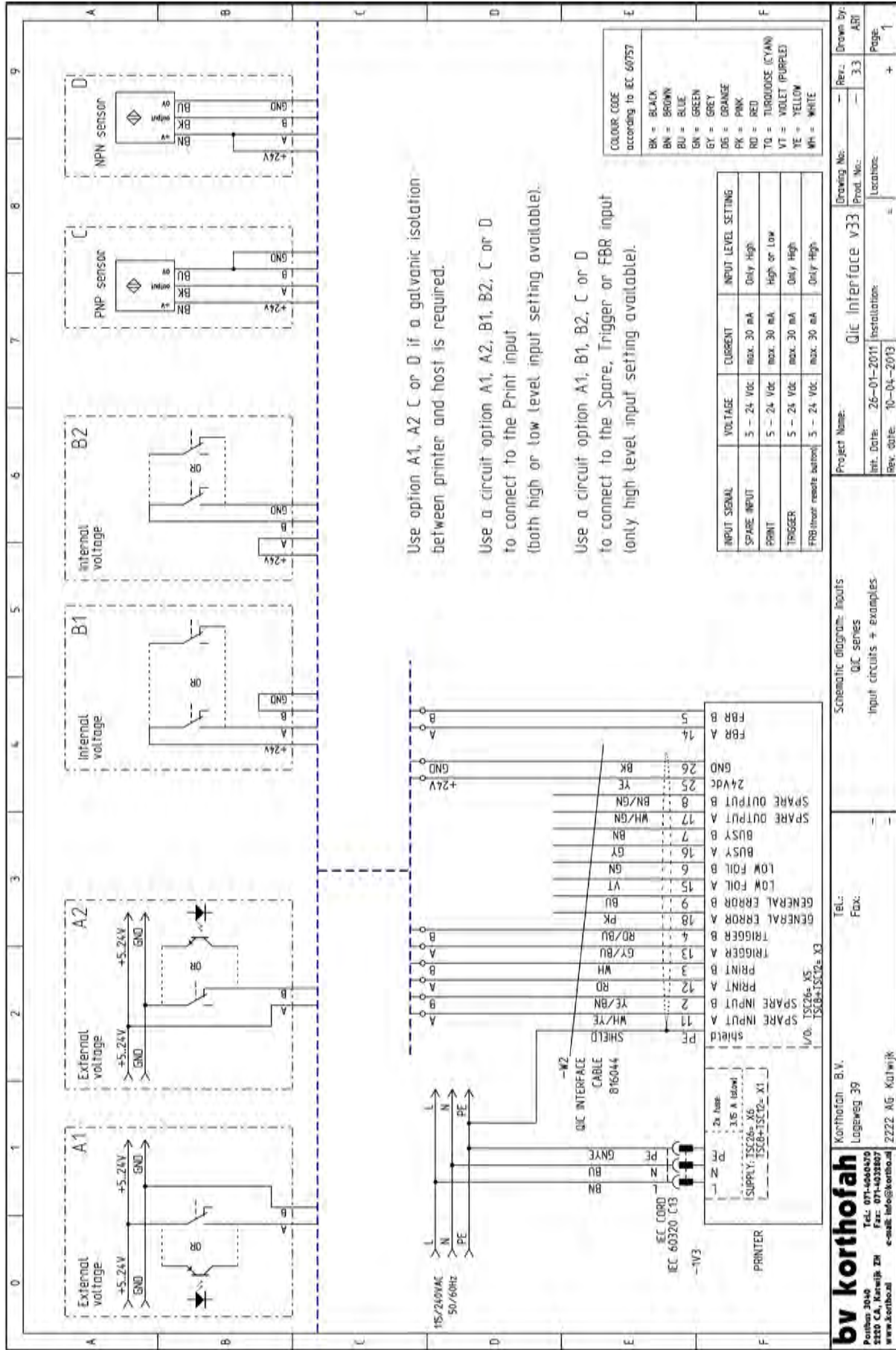

Project Name: QIC Interface v33
 Drawing No.: 33
 Rev. date: 26-01-2011
 Rev. 03/10-04-2013
 Location: +

Schematic diagram: Inputs:
 QIC series
 Input circuits + examples

TEL: Korthofah B.V.
 FAX: Logeweg 39
 P.O. Box 3040
 5350 CA, Korthofah ZH
 www.korthofah.nl
 Tel: 071-4040370
 Fax: 071-4033807
 e-mail: info@korthofah.nl

X3 Schematic diagram (output)

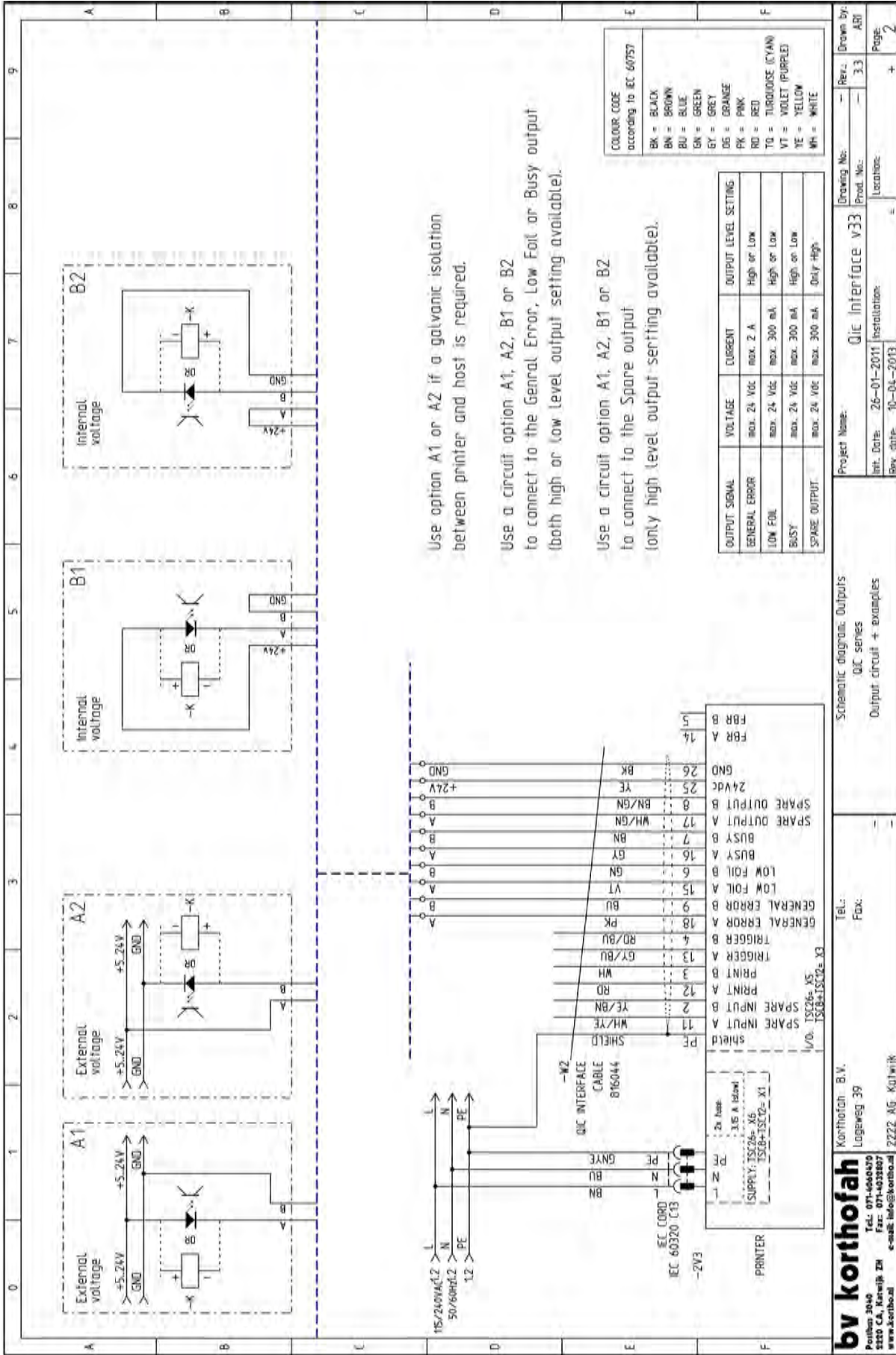

X3 Circuit diagram (input)

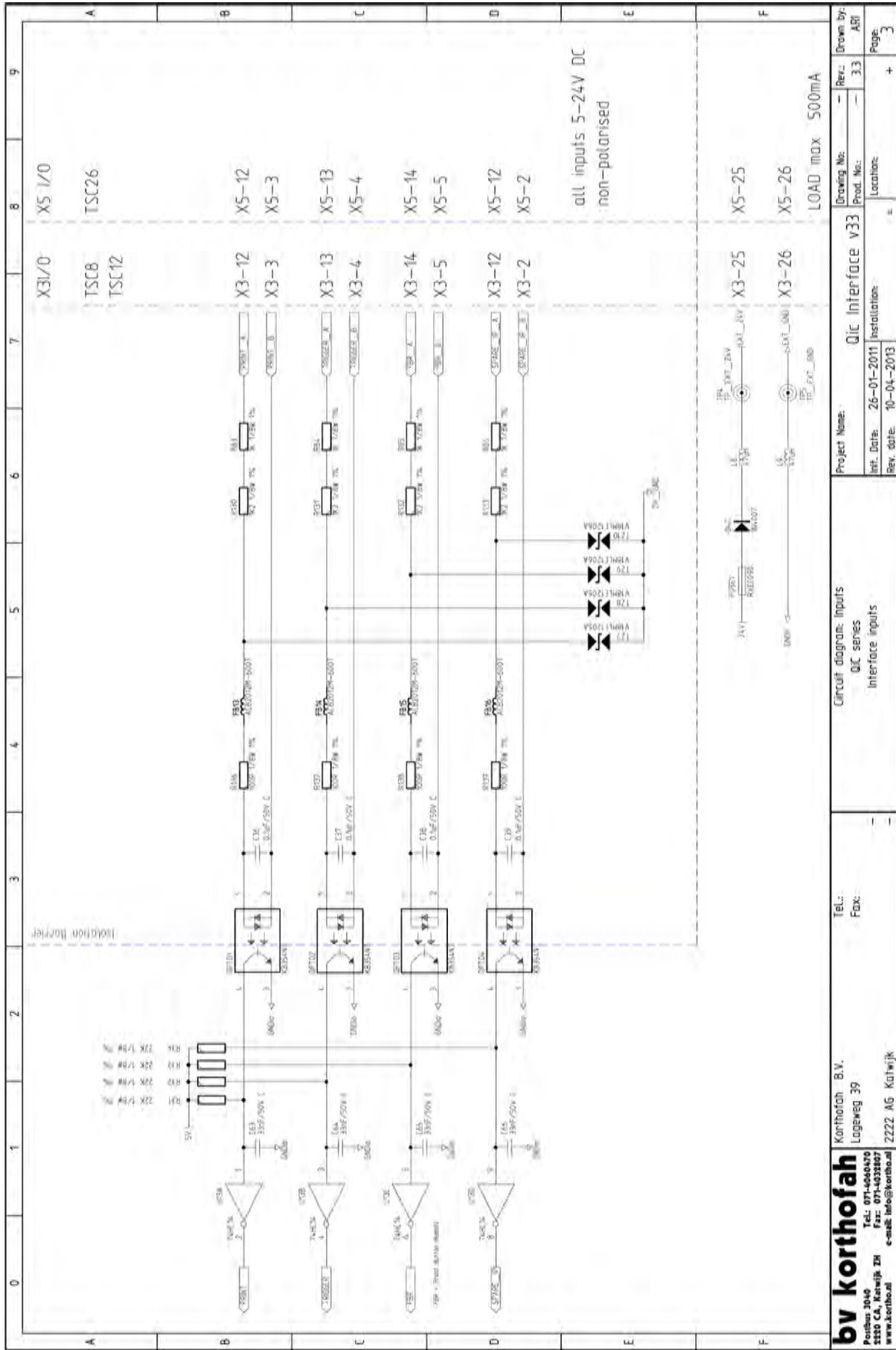

X3 Circuit diagram (output)

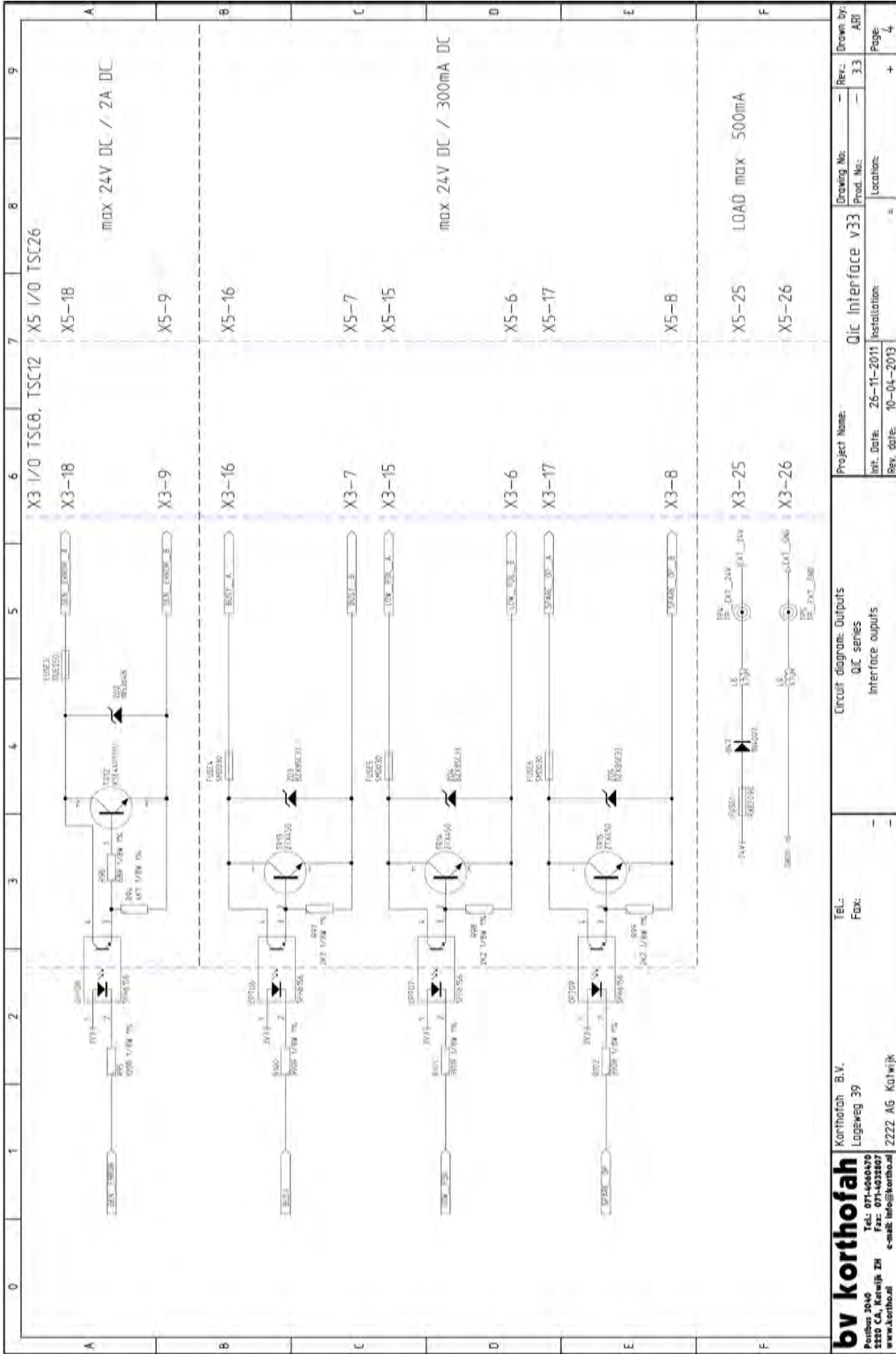

bv korthofah Postbus 3040 5220 CA, Kerwijk ZH www.korthof.nl		Tel.: 071-4040420 Fax: 071-4033807 e-mail: info@korthof.nl		Korhofah B.V. Logeweg 39 2222 AG, Katwijk		Tel.: Fax:		Project Name: QIC Interface v33 Int. Date: 26-11-2011 Rev. date: 10-04-2013		Drawing No.: Prod. No.: Location:		Rev.: 3.3 Drawn by: ARI Page: 4	
--	--	--	--	---	--	---------------	--	---	--	---	--	---------------------------------------	--

X3 Schematics diagram User

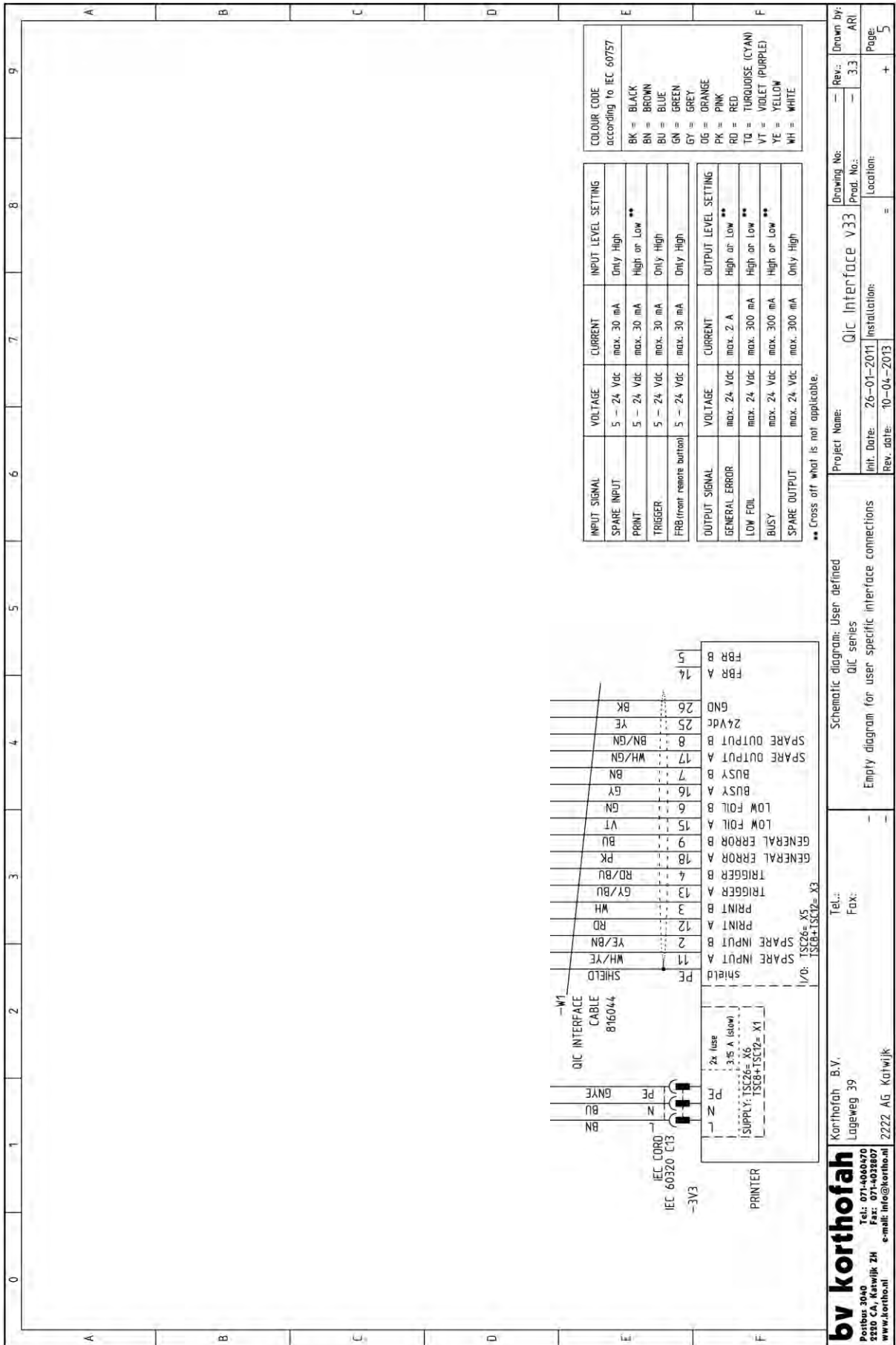

This diagram can be used to note the specific user settings.

Pneumatic circuit diagram 30i/53i/107i

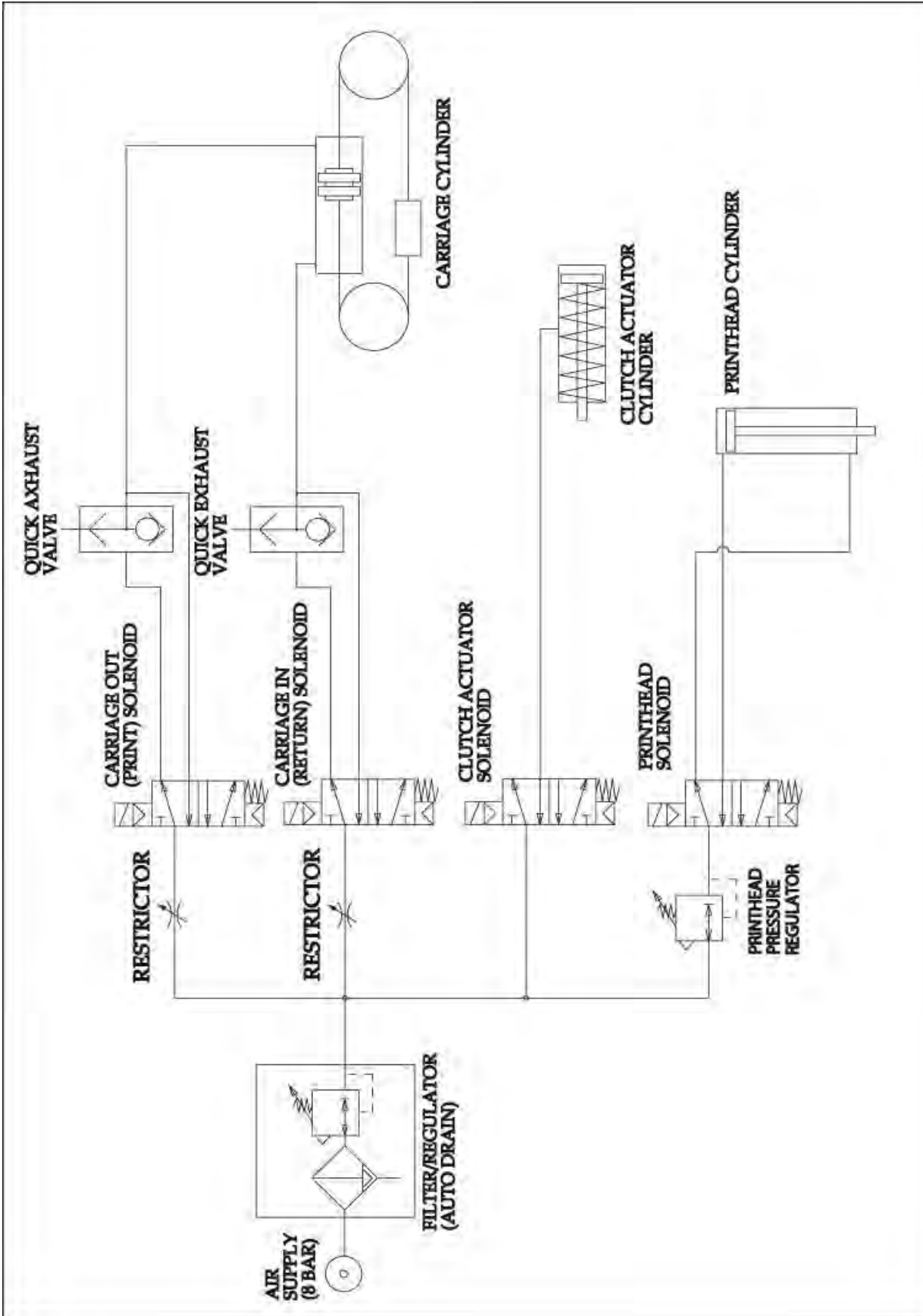

Appendix E NiceLabel driver tutorials

Installation and configuration of the driver	E-2
Function of the driver	E-2
Versions of the driver	E-2
Installation of the driver	E-3
Configuration of the driver	E-6
Summary.....	E-8
Downloading a label through USB.....	E-9
Introduction	E-9
Installation of the driver.....	E-9
Download a label through USB	E-10
Sending a label on a network	E-11
Introduction	E-11
Installation of the driver.....	E-11
Sending a label on a network	E-11

Installation and configuration of the driver

This appendix is based on the general description for the installation and configuration of the driver. The procedures are based on the Kortho GraphicJet X18. It speaks for itself that if one like to perform the procedures for the QiC Thermal transfer printers, one should select the desired printer model instead of the Kortho GraphicJet X18.

Function of the driver

The printer driver can be installed on a PC/laptop in order for a printer to receive and execute print commands from a PC/Laptop. Every printer has its own driver. In order to control 5 individual printers with 1 PC/Laptop, it is therefore required to have 5 individual drivers on that PC/Laptop. The driver for the Kortho printers (named NiceDriver) is Windows based. This means that the driver (and with that the Kortho printers) can be controlled by all common Windows systems. Most ERP systems are also capable of printing to a Windows driver. This means that one could control all Kortho printers in a production plant by using 1 central ERP system (SAP, Microsoft Dynamics NAV etc.).

For every printer under control, there is a driver installed on the PC/Laptop:

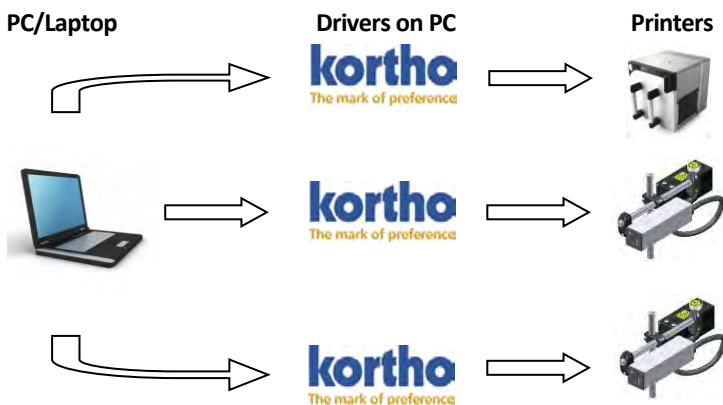

So if there are several lines and/or several printers that should receive print commands from 1 single PC/Laptop, there should be a driver installed for each printer. The driver translates every signal sent from the PC/Laptop separately, and translates these signals into a signal the printer can create an image out of.

Versions of the driver

In order to have a driver communicate correctly with a printer, it is important for the driver's version to be compatible with the printer's firmware version. To be sure the right driver will be installed, the firmware should be checked first. To check the firmware version of the printer:

1. Touch the *Information* icon.
2. Touch the *System info* button.

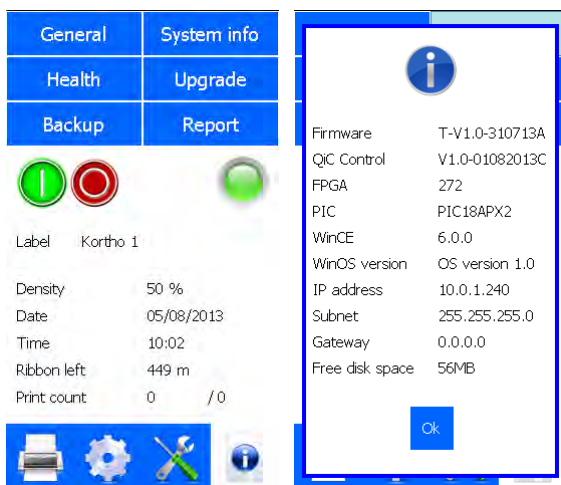

After checking the firmware version the compatible driver can be downloaded from the Kortho website (www.kortho.com).

In general the following firmware-driver combinations are compatible:

- Driver version: 4.6.63 (Build 3230) and higher
- Minimal Printer Firmware version: V1.0-16032011

For firmware lower than this version, use driver version 4.6.44 or turn the two-way support off at the driver's port setting.

Installation of the driver

As soon as the compatible driver has been downloaded, it can be installed on the PC/Laptop which is going to control the printer(s).



Beware:

If the label needs to be downloaded through a USB thumbdrive one should set the driver accordingly, see [Downloading a label through USB, Installation of the driver](#). The description below is based on the situation in which the label is send to the printer through the Ethernet.

To install the driver:

1. Unzip the downloaded file.
2. Start the installation by executing the program PrnInst.exe.
3. Click *Next*.

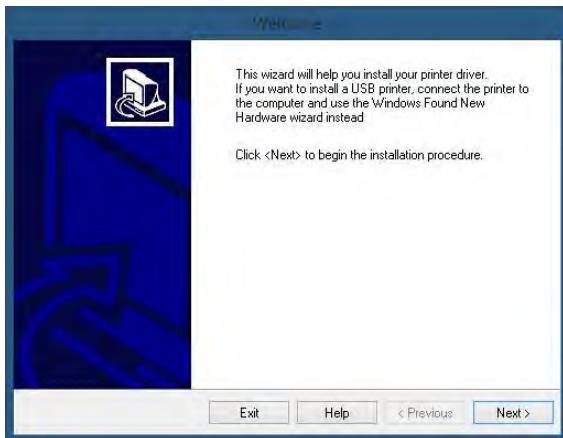

4. Accept the conditions and click *Next*.



5. Select the desired printer and click *Next*.

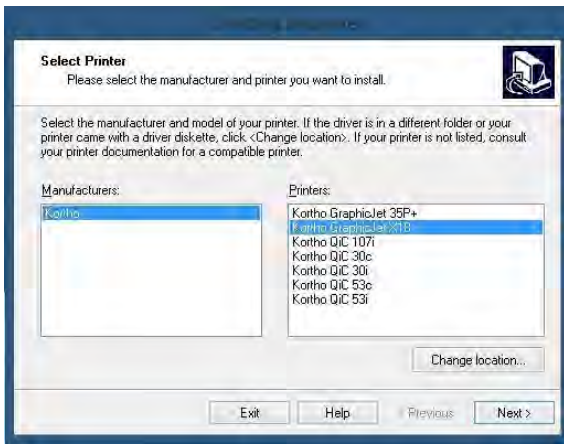

6. Click *Add Port*.

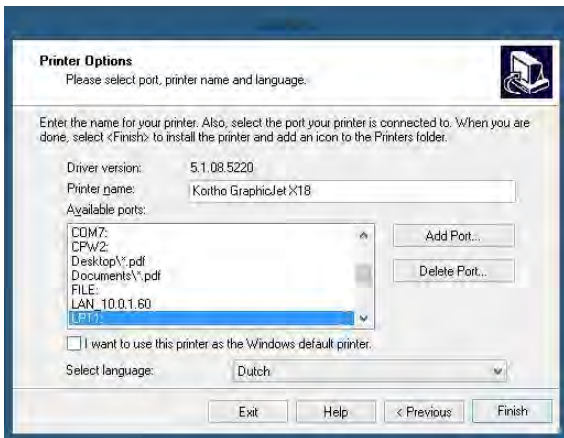

7. The Advance Port Monitor Configuration will appear. Execute the following steps:
- a. Enter printer's IP address (Port name automatically changes with the IP address, for example IP: 192.168.1.10).
 - b. Optionally enter a Name for the port (So that the port is easily recognized, for example: X18_line).
 - c. Enter the Port number (With a Korho printer this is always **14322**, this is the control unit's fixed number).
 - d. Click OK (A printer port will be created).

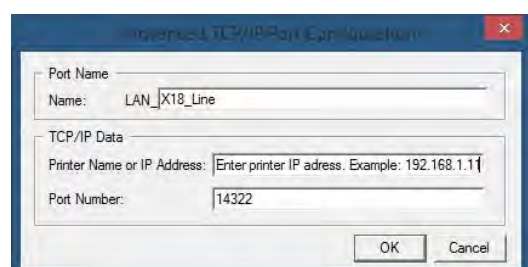
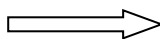
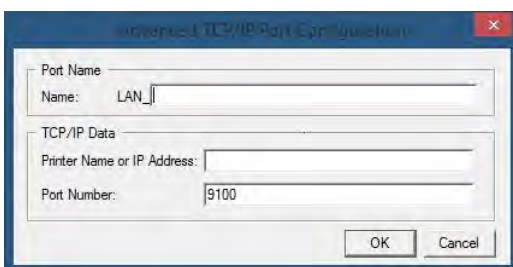

8. The printer is now selected automatically out of the list of available ports.
9. Optionally:
 - a. Give the printer a Printer name.
 - b. Select a language for the printer's properties.
 - c. Select the printer as standard printer.

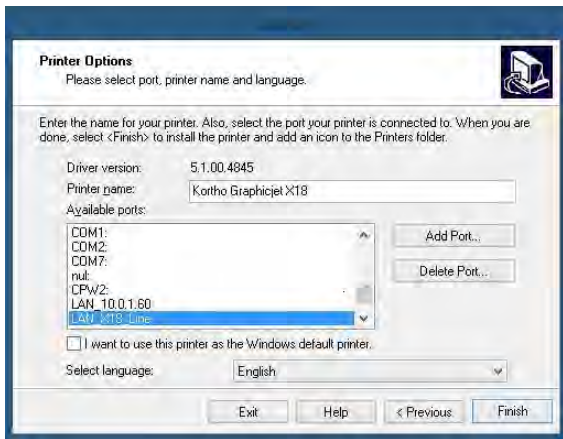

- 10. Click *Finish* to close the screen. A progress screen will appear installing the driver.
- 11. Open the printer configuration screen in Windows. This is found in Windows “Start” or in “Start > Configuration screen”. The printer is added as shown below:

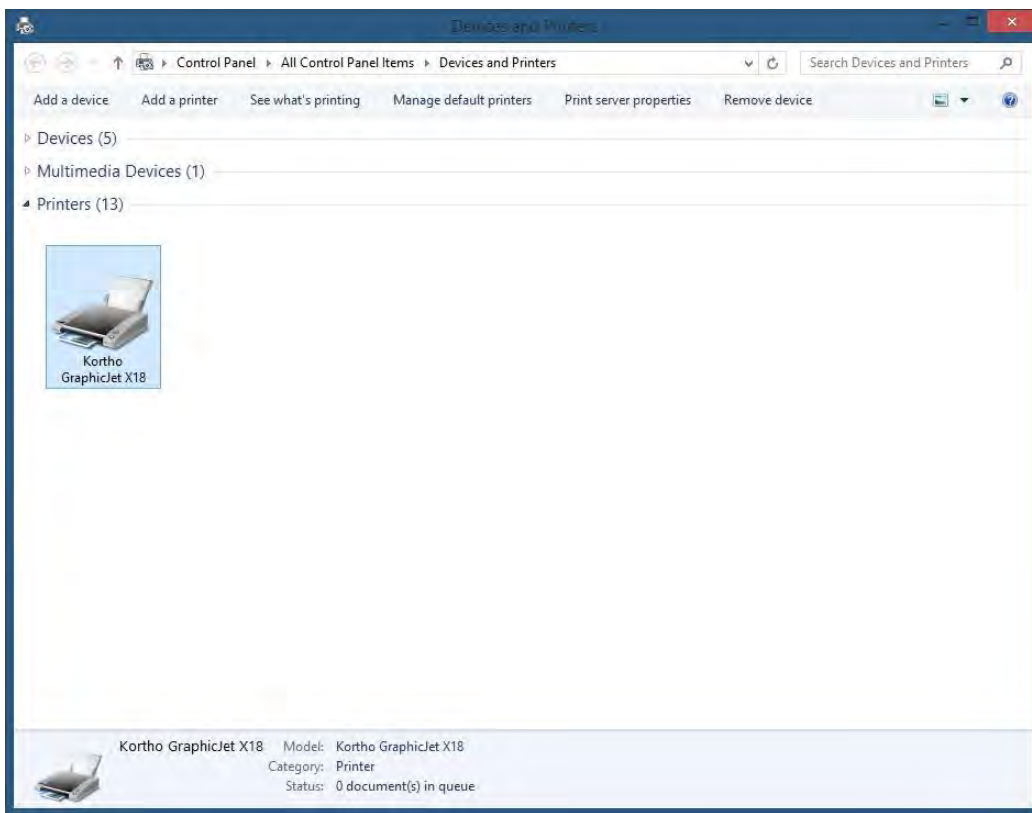

- 12. Right click on the printer and select *Printer properties*.

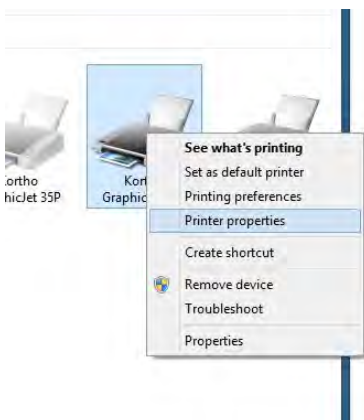

13. Select the tab *General*.

14. Click *Print Test Page* to test the installation. The printer will print het Windows logo.

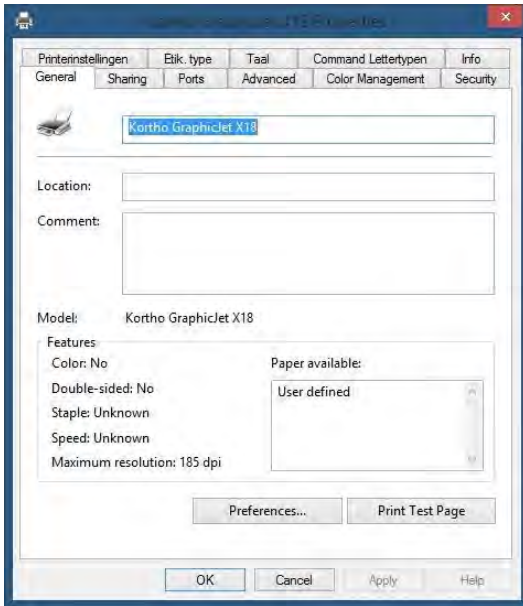

Configuration of the driver

In order to more easily work with the printer and set up labels, a standard label type can be set.

1. Open the printer configuration screen in Windows. This is found in Windows "Start" or in "Start>Configuration screen".
2. Right click on the printer and select *Properties*.
3. Select the tab *Etik. Type*.

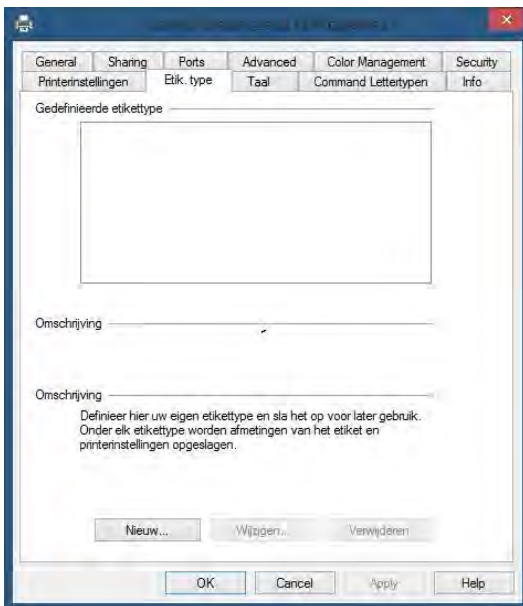

4. Click *New* (Nieuw).

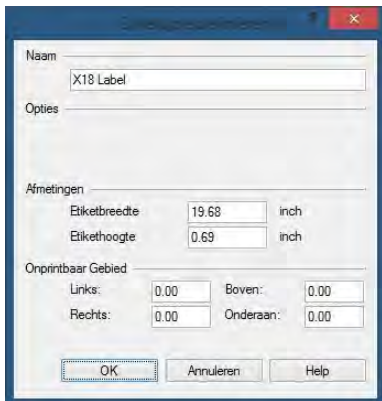

5. Enter the Label length and Label width (Labels can be defined, so that the label stays within certain dimensions. That is how label programs like NiceLabel take the printer's printable surface into account).
6. Enter a Name for the label.
7. The values for unprintable areas for the Kortho printers are already correctly set to 0,0.
8. Click *OK* to close the screen.
9. The label with the right dimensions of printable area (which will be taken into account by the printer) is now added to the list of labels for the printer "Kortho X18_Line 1". When using several Kortho printers the standard label will have to be added separately for each printer.

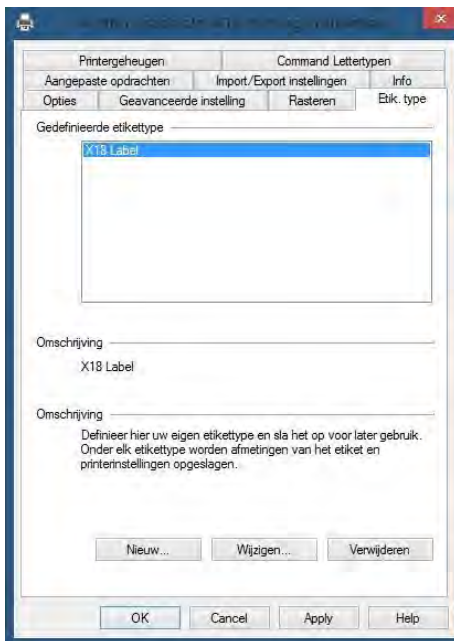

10. Click *New* (Nieuw) again to add another label definition or click *OK* to close the screen.

When designing a label in a designing program one can select the printer "Kortho X18_Line 1" and after that "X18 Label" as a label/tag/paper size (name depends on the label design program). The program will take the printers parameters of the selected label/tag/paper size into consideration.

Because the Kortho driver was developed by NiceLabel, the driver can define NiceLabel's settings. Within NiceLabel, the only options available will be actions that the printer will actually support. Due to this, the margins for errors due to wrong configuration/settings is limited and it is beneficial to the user friendliness. To adjust these settings:

1. Open the printer configuration screen in Windows. This is found in Windows "Start" or in "Start > Configuration screen".
2. Right click on the printer and select *Printer properties*.

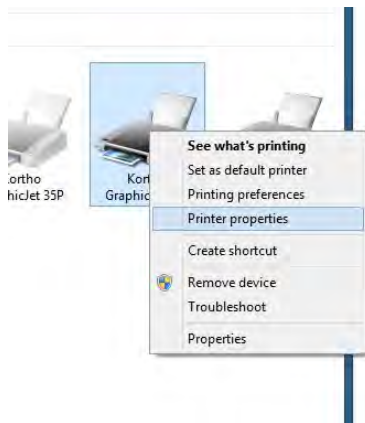

3. Select the tab *Advanced settings* (Geavanceerde instelling).
4. Check the box *Use printer settings* (Gebruik printer instellingen) to let the printer parameters manage the label programs settings. If this box is not checked, the driver will overwrite the printer's settings the moment a print command is sent.
5. Click *OK* to close the screen.

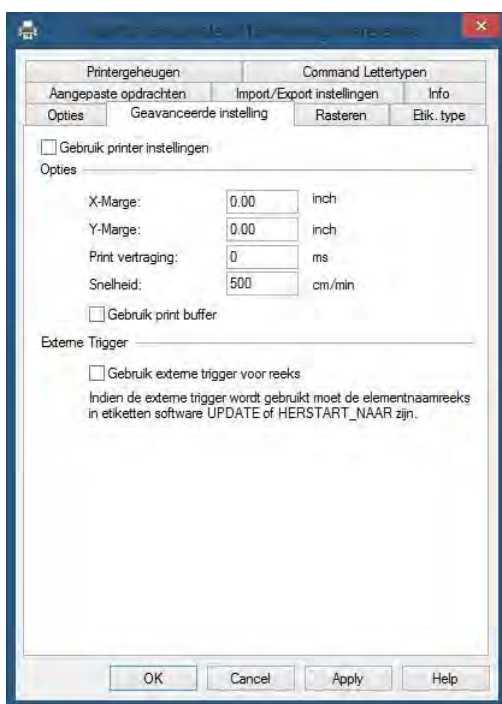

Summary

The Kortho GraphicJet X18 can be installed on any Windows PC/Laptop in the same way a “normal” desktop printer is installed. After installation the printer can be chosen amongst the other (desktop) printers currently in use on the PC/Laptop.

After installation of the driver the printer’s print area can be defined. By doing this the driver can communicate the information back to a label design program (like NiceLabel, Bartender etc.). When defining the lay-out of a label, the program will take the printer’s parameters into account. With a normal desktop printer for example the parameter for the printable area is A4. With a Kortho printer the printable area depends on the printer model.

Because the driver was developed by NiceLabel, it is not only automatically certified for use with all Windows systems/Label design programs. The advantage of using NiceLabel is that while defining the label’s lay-out, one can take the printer properties and setting into account. Due to this the settings (like print area, speed, contrast and method of data transfer) are automatically set correctly. So by using NiceLabel the system not only becomes more user friendly, but it also decrease the chance of errors due to incorrect settings.

Downloading a label through USB

Introduction

The labels can be designed with a PC based design tool or they can be designed on the control unit. The labels designed with a PC based design tool can be downloaded to the control unit by Ethernet or by USB thumbdrive. The labels from a thumbdrive will be stored in the label memory, while the label downloaded by Ethernet will be stored in the printer mamemory and cannot be reselected manually from the control unit.



Beware:

Before a label be downloaded through a USB thumbdrive it needs to be printed to a Printfile (*.prn). It is not possible to download the original label file to the printer.

Installation of the driver

As soon as the compatible driver has been downloaded, it can be installed on the PC/Laptop which is going to control the printer(s).

To install the driver:

1. Unzip the downloaded file.
2. Start the installation by executing the program PrnInst.exe.
3. Click *Next* (Volgende).
4. Accept the conditions and click *Next*.
5. Select the desired printer and click *Next*.

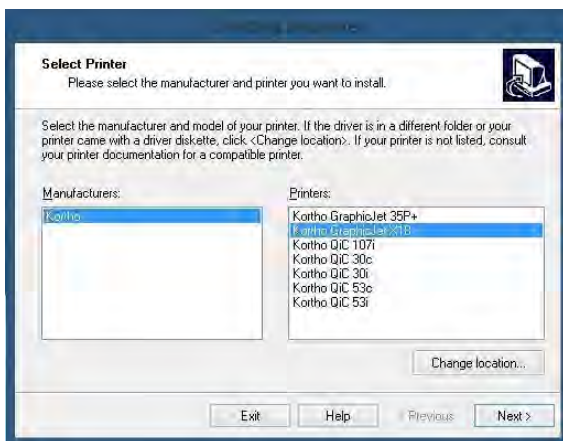

6. Select *FILE:*, change the printer name (optional) and click *Complete* (Voltoeien).

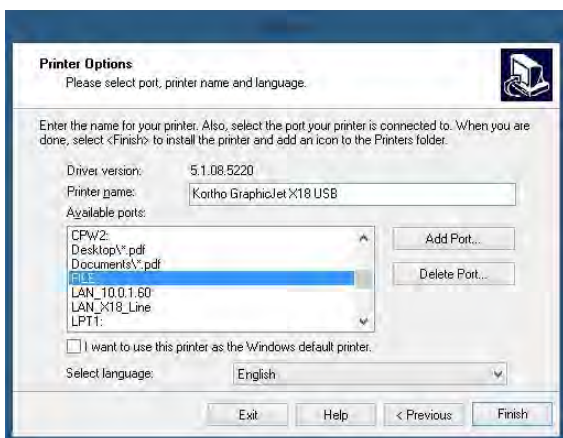

The driver is now installed on your PC/laptop and can be used to generate Printfiles.

Download a label through USB

To download a label by a USB thumbdrive:

1. Start NiceLabel and design a new label (or open an existing one – continue with step 4).



Beware:

To guarantee a good print result it is important that the label is designed for the printer to which one would like to download the label.

2. Select the right printer (driver configured to print to File as described above) and click *Finish*.

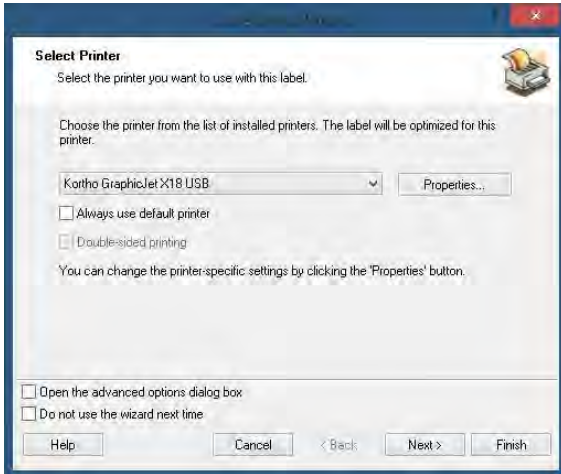

3. Save the new label design.
4. Insert a USB thumbdrive into the PC/laptop.
5. Select *File – Print* to print the label.

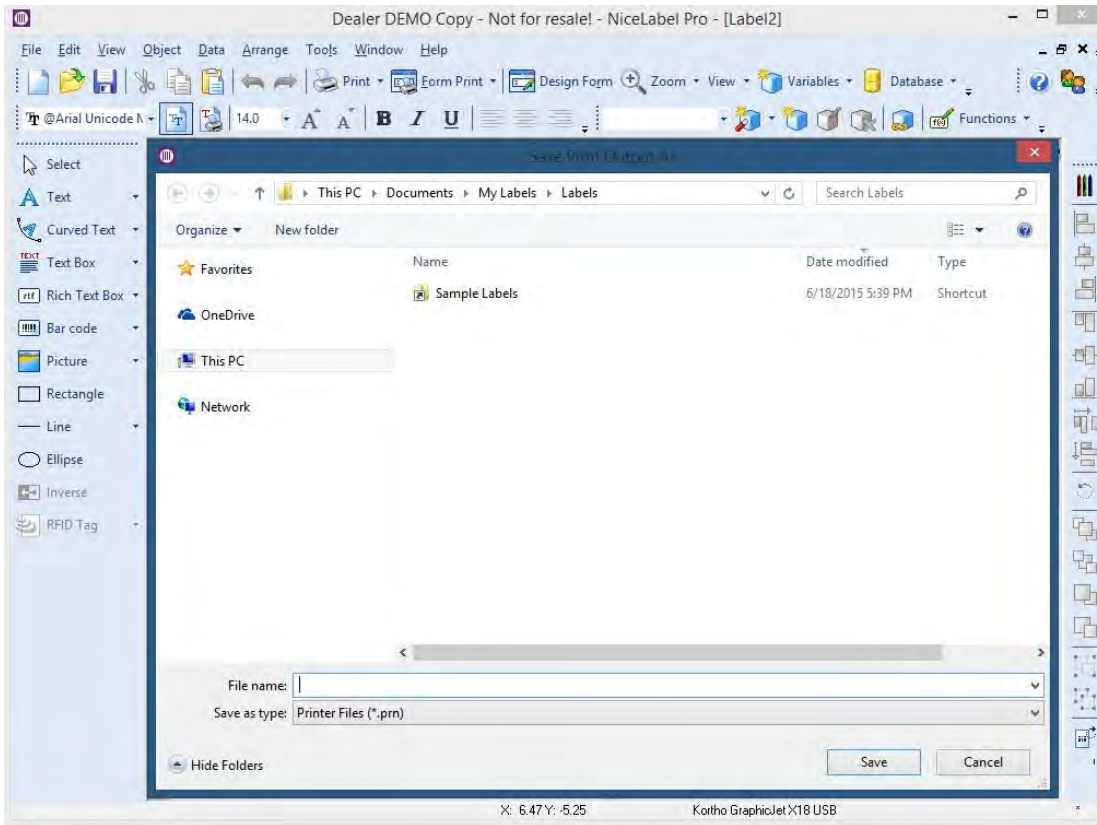

6. Choose the location of the USB thumbdrive to save the Printfile.

7. Give the Printfile a name including the extension prn, e.g. Testlabel.prn (preferably the same name as the Label name, in this way there is a clear relation between the Printfile (which cannot be edited) and the Labelfile (which can be edited)).
8. Click Save to save the Printfile on the USB thumbdrive.
9. Dismount the USB thumbdrive, so it can be safely removed from the PC/laptop.
10. Remove the USB thumbdrive.
11. Insert the USB thumbdrive into the control unit and wait for 4 seconds so it can be detected and mounted.
12. Copy the printfile on to the control unit by following the procedure as described in chapter 8.4.2.
13. Select the printfile for printing by following the procedure as described in chapter 8.4.1.

Sending a label on a network

Introduction

The labels can be designed with a PC based design tool or they can be designed on the control unit. The labels designed with a PC based design tool can be downloaded to the control unit by Ethernet or by USB thumbdrive. The labels from a thumbdrive will be stored in the label memory, while the label downloaded by Ethernet will be stored in the printer memory and cannot be reselected manually from the control unit.

Installation of the driver

Install the driver as described in Installation and configuration of the driver, Installation of the driver.

Sending a label on a network

To download a label through Ethernet:

1. Start NiceLabel and design a new label (or open an existing one – continue with step 4).
2. Select the right printer (driver configured to Port as described above) and click *Complete* (Voltooien).

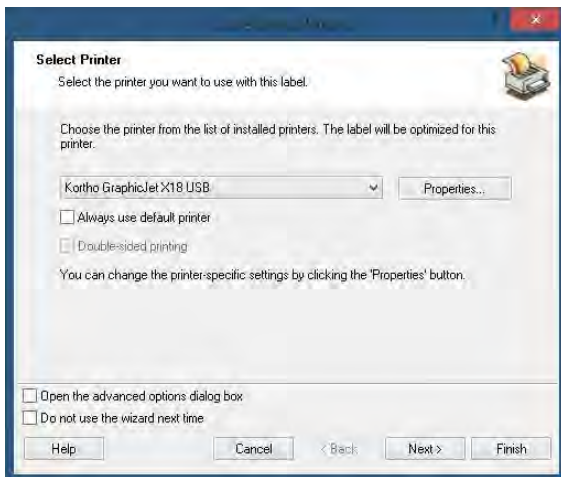

3. Save the new label design.
4. Select *File – Print* to print the label.



Beware:

To guarantee a good print result it is important that the label is designed for the printer to which one would like to download the label.

5. Select the amount of prints that need to be made.

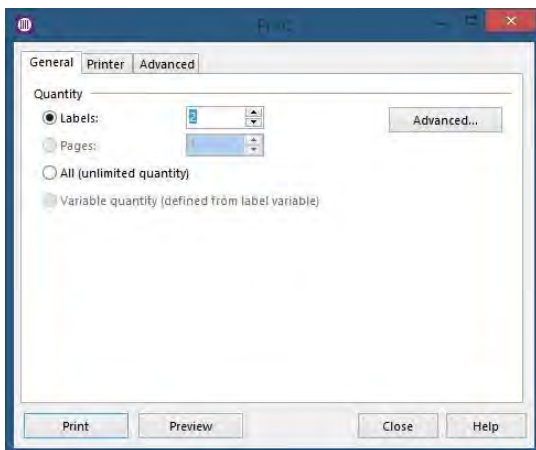

6. Select *Print* and the printer will start printing the selected label.

Appendix F Quick reference

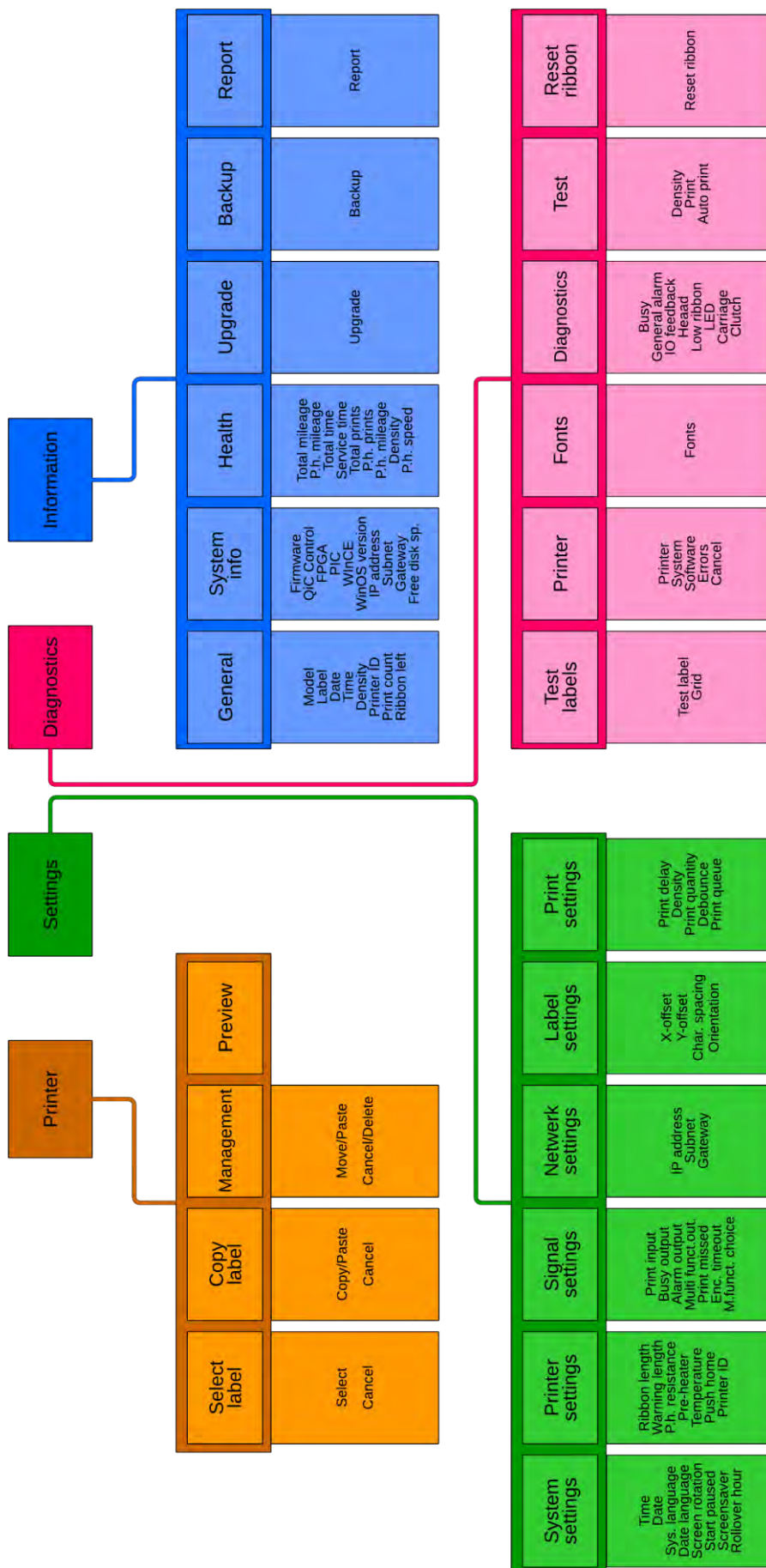

Appendix G Error list

The following errors / warnings can be generated by the system:

- Error 00 Initialising Ethernet
- Error 01 An error occurred while loading fonts.
- Error 02 There are too many auto codes in the label.
- Error 03 PIC not responding.
- Error 04 A font in the label is not installed. Please install the font.
- Error 05 The software has a problem with addressing the EEPROM. Try again or upgrade the software.
- Error 06 There is not enough memory space available for the font.
- Error 07 The maximum storage space for a label is 96Kb. Reduce the file size.
- Error 08 The printer received an incomplete message. Try again.
- Error 09 The CRC check of the message is incorrect.
- Error 10 Security token old. Login again.
- Error 11 There is a problem with the Flash memory.
- Error 12 There is a problem with the ribbon encoder.
- Error 13 Unknown command received. Check the command or upgrade the firmware.
- Error 14 Minimum value is
- Error 15 Maximum value is
- Error 16 Missing value.
- Error 17 Maximum digits for
- Error 18 Maximum characters for
- Error 19 Date invalid.
- Error 20 Time invalid.
- Error 21 Wrong name or missing variable.
- Error 23 Maximum users
- Error 24 Access Denied.
- Error 25 An unknown error occurred. Turn the printer off and back on after 10 seconds.
- Error 26 A problem occurred while generating the label. Try again.
- Error 27 Wrong coding unit connected. Connect the appropriate coding unit.
- Error 28 Font Error.
- Error 29 There is a problem with the font. Check Windows whether the font is correct.
- Error 30 The printhead carriage does not return to home position.
- Error 31 There is a problem with the ribbon transport.
- Error 32 A timeout occurred for the print position.
- Error 33 A print is missed. The print request signal was received while printing.
- Error 34 The label is too small or the font is missing. The label must be at least 3 mm in size.
- Error 35 A timeout occurred for the print-encoder.
- Error 36 The ribbon encoder is connected incorrectly. Swap the wires.
- Error 37 The carriage encoder is connected incorrectly. Swap the wires.
- Error 38 First user must be manager.
- Error 39 User list empty.
- Error 40 Security disabled.
- Error 41 Print magazine missing or placed incorrect.

APPENDIX F, QUICK REFERENCE

Error 42	Wrong FPGA. The software is incompatible with this model type. Load the appropriate software.
Error 43	Wire too tight.
Error 44	The printer is paused. Start the print process to continue.
Error 45	The coding unit type is unknown. Check the coding unit and connections.
Error 47	There is no coding unit detected. Connect a coding unit or check the connections.
Error 48	The total size of the multi-label is too large. Reduce the label size.
Error 49	Maximum number of labels reached. Remove a label before adding a new one.
Error 52	The printer is almost out of ribbon.
Error 53	Printhead carriage encoder error. Check the air pressure and the mounting of the encoder.
Error 54	There is no label loaded to print. Load a label.
Error 55	Use internal encoder for test prints.
Error 59	The PX2 board is not calibrated. Calibrate the PX2 board.
Error 60	Preview too large.
Error 61	The speed of the line is too low. The speed must be at least 40 mm/s (2,4 m/min).
Error 62	The speed of the line is too high. The speed can be up to 550 mm/s (33 m/min).
Error 63	Printhead temperature.
Error 65	Print missed.
Error 66	Printhead encoder timeout.
Error 67	Under minimum speed.
Error 68	Over maximum speed.
Error 69	IP address invalid.
Error 70	Use command when paused.
Error 71	Wrong PX2 OS version.
Error 72	Some text is outside of the label area. Use label anyway?
Error 73	A graphic is outside of the label area. Use label anyway?
Error 74	An error occurred during booting. The label was removed.
Error 75	Print ramp timeout
Error 76	Loading variable backup
Error 77	Loading ontime backup
Error 78	Loading voltage backup
Error 79	Loading model backup
Error 80	Backup EEPROM failed
Error 81	Counters Reset
Error 82	Label made for another printer type.
Error 83	Total length of label including Y-offset is too long. Y-offset reset to 0.
Error 84	Print stopped. Print quantity has been reached.

Appendix H EC Declaration of conformity

(According to Annex II.A of the Machinery Directive 2006/42/EC)

We, BV Korthofah
 Lageweg 39
 2222 AG Katwijk ZH
 Nederland

declare under own responsibility that the product

Control unit TsC12, QiC 30i	(817332)
Control unit TsC12, QiC 53i	(818242)
Control unit TsC12, QiC 107i	(818255)
Coding unit QiC 30i	(816629)
Coding unit QiC 53i	(816311)
Coding unit QiC 107i	(815722)

to which this declaration relates is in conformity with the following standards or other normative documents

NEN-EN-ISO 12100:2010
FSO/TR 14121-2:2007
EN 60950-1 (2006) + A1 (2010) + A11 (2009) + A12 (2011) + A1 (2011) + A2 (2013)
EN 61000-3-2 (2006) + A1 (2009) + A2 (2009)
EN 61000-3-3 (2008)
EN 60204-1 (2006) + A1 (2009)
EN 61000-6-4 (2007) + A1 (20011, class A)
EN61000-6-2 (2005) + A1 (2005), Industrial

following the provisions of the

Machinery Directive 2006/42/EC
EMC Directive 2004/108/EC
Low Voltage Directive 2006/95/EC



M.P.J.J. de Groot, Directeur
Februari 25th 2016, Katwijk ZH, Nederland

bv korthofah

P.O. box: 3040
2220 CA, Katwijk
The Netherlands
